

# 4-H CLUB COMMERCIAL LAMB FATTENING PROJECT

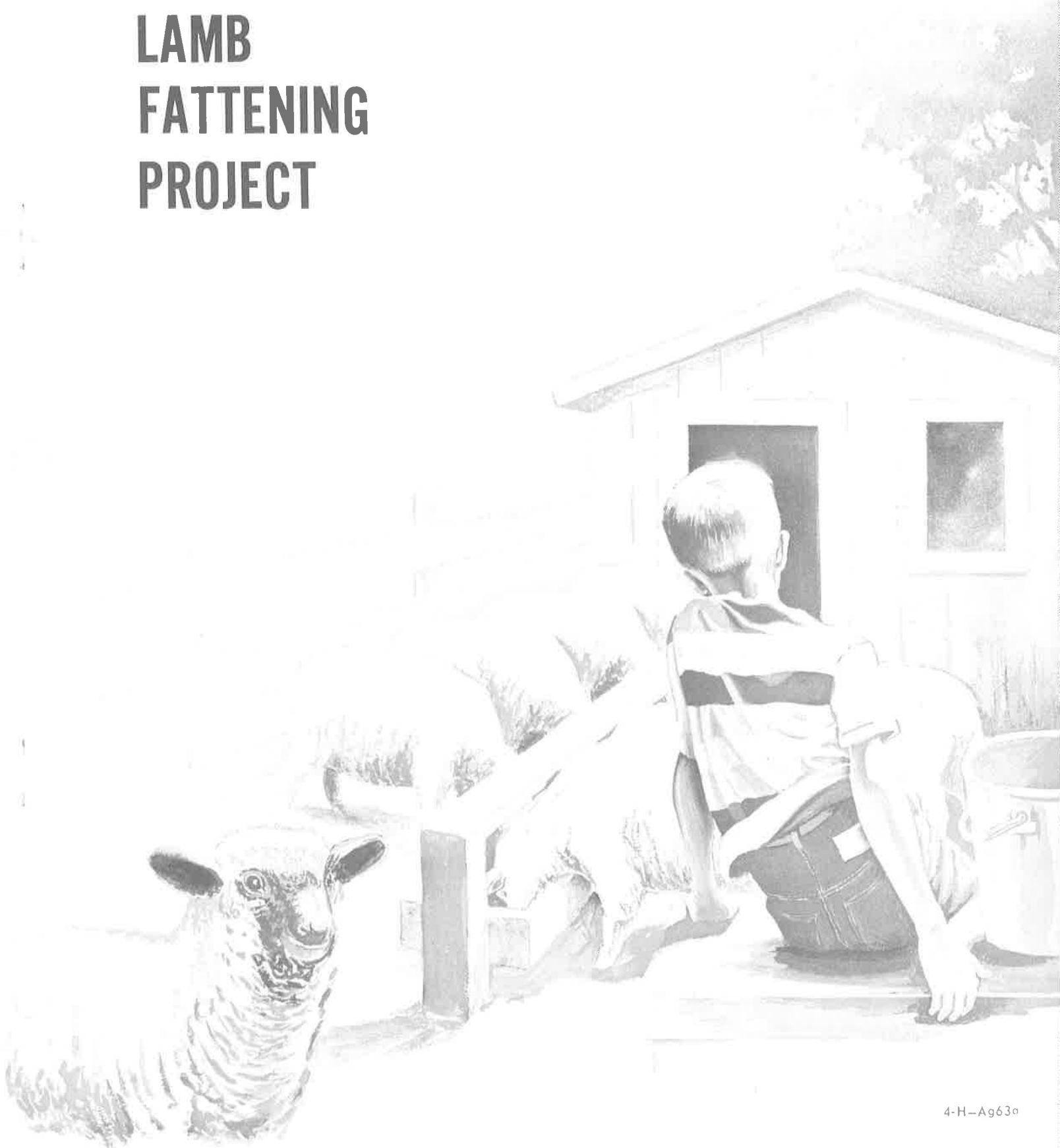

*This publication was prepared by Ray G. Lyon, Farm Advisor, Glenn County, and Hebert L. McCabe, Jr., former Farm Advisor, with assistance from Monte Bell, Farm Advisor, Glenn County; Reuben Albaugh, Extension Animal Scientist Emeritus, and Jack E. Herr, Farm Advisor, Placer County.*

*Special acknowledgment is made to Alex Gibson, Farm Advisor, Stanislaus County and Dick Fleming, former Farm Advisor, for their help and assistance in developing this manual.*

## 4-H CLUB COMMERCIAL LAMB FATTENING PROJECT

4-H Club members who have raised at least one lamb to market weight will be interested in carrying the 4-H Commercial Lamb Fattening Project. This project offers the opportunity to purchase ten or more feeder lambs, raise them to market weight and market them as a practical, commercial enterprise.

In this project you will learn:

- To feed a group of lambs on a sound businesslike, commercial basis.
- To purchase lambs of the type fed by commercial feedlot operators.
- To efficiently use home-grown feeds, including forages.
- To develop your own feeding and management programs and evaluate the results of these programs.
- To buy wisely, feed economically, manage properly and market to your best advantage.
- The value of good records in practical buying, feeding and marketing.

### How to Enter

To enter this project, complete the application form at the end of this manual. Have it signed by your parents and your local 4-H leader and return it to your farm advisor.

### Rules and Regulations

- A 4-H member who has raised at least one lamb to market weight at the time the lambs are purchased is eligible to participate in this practical feeding project, upon completion and approval of the entry form.

- The project will consist of a minimum of 10 lambs, any breed. Final summaries will be figured on a "per-head" basis. All lambs for this project will be identified at time of purchase. No substitutions will be allowed.

- Lambs in each pen should be of uniform quality and weight. A project leader or committee will help locate the feeder lambs to be fed in this project.

Following selection and identification of the feeder lambs, it will be the responsibility of the 4-H members to provide or pay the cost of transportation of these lambs to their own feedlots.

- Lambs must be on feed by the date determined within the club or county. The length of the feeding period will approximate 100 days. Any combination or amounts of feed desired can be fed. Accurate records must be kept!

Marketing date will be determined by the member and the project leader. The date will depend upon the weight and grade of the lambs and the market situation.

- Lambs in this project must be kept and fed separate from other animals.
- Each feeder must keep an accurate and complete feed record at all times in the record book supplied for this purpose. These records must be kept current.
- Lambs cannot be exhibited as individuals, and do not have to be fitted for show.
- Exceptions to these rules can be made only at the discretion of the project leader or committee.

## Procedures

- 4-H members are encouraged to make arrangements for financing the project through local banks, production credit associations, or other lending agencies. This gives an opportunity to become acquainted with the banker and banking procedures. It sets up the project in a businesslike manner and establishes a credit rating.
- The feeder is expected to work out a businesslike arrangement with his parents or others for purchase of feed, use of equipment, and other costs involved.
- An advisory committee or your 4-H leader will visit the project approximately every 30 days to compare management and feeding practices and check records and, if possible, weigh the lambs.
- A member is responsible for marketing his own lambs with the help of his project leader or committee. Every effort should be made to follow the lambs through slaughter and obtain a "killing" report.
- Members in this project must attend meetings of the project group. The frequency of these meetings will be determined by the members themselves with the project leader or project committee.
- Insurance on these lambs should be taken out by the 4-H member.
- A summary of this project will be made at the conclusion of the project year.
- Recognition of individual accomplishment may be given according to the following scorecard:
 

Net return	25%
Rate of gain	15%
Cost per pound of gain	15%
Know-how as demonstrated through project management	15%

Neatness, completeness and accuracy of records 25%  
 Project story (not more than 300 words) 5%

## Feeding Your Lambs

There is no one way to feed lambs. You will need to plan for, and provide, feed that will put growth and weight on your lambs quickly. You will have to consider the feeds raised on your farm and buy those feeds necessary to balance your feed ration. You will need to study the sheep market and feed situation to help you decide your system of feeding.

Several systems of feeding lambs can be adapted to this lamb fattening project. The relative amounts of grain and roughage available are important factors which must be considered in determining your feeding system.

Dry Lot (in corrals with no pasture) – Same mix throughout feeding period.

a. **Pellets:** average daily feeding – 4 pounds.

	Pounds
Alfalfa	65
Barley	30
Molasses	5
	100

b. **Grain and alfalfa hay:** use barley or milo or both. Average daily feeding—2 pounds grain and 2 pounds alfalfa hay.

Pasture and Supplement.

**Supplement:** average daily feeding—1 pound.

	Pounds
Barley	80
Beet pulp	15
Cottonseed meal	5
	100

Substitutions in the above examples may be made. Evaluation of your feed from the standpoint of cost is important, and you may make substitutions to reduce costs. Consult your project leader on this subject.

Start your lambs on grain by feeding  $\frac{1}{4}$  pound of grain on the first day and increasing the amount gradually at a rate of approximately  $\frac{1}{4}$  pound every two days. Feed the amount your animal will clean up in approximately 2 hours at each feeding.

### Some Rules of Thumb on Feeding

1. The average gain per day for a lamb on full feed is  $\frac{1}{3}$ – $\frac{1}{2}$  pound. He will eat up to 4 pounds of grain and hay on full feed.
2. Minerals are necessary for the health of animals. Have a mineral supplement, such as steamed bone meal, available free choice.
3. Regularity of feeding is important if lambs are to make good gains. Feeding ration in the morning and again in the evening is the method practiced by many feeders. For best results, hay should be chopped or coarsely ground and mixed with coarsely ground or rolled grain. However, hay may be fed free choice, providing the lambs eat the required amount of grain.
4. An ample supply of clean, fresh water is required. Clean troughs regularly, and keep them free of all algae and debris.
5. Shrewd buying, skillful feeding, and wise marketing determine profits of lamb feeding.
6. Lambs should be drenched with micronized purified phenothiazine when they enter the feedlot and/or when put on pasture. When on pasture have a mix of 1 part phenothiazine to 9 parts salt available free choice.

### Feed Additives and Hormones

The use of stilbestrol for maximum economy of gains is advisable. Lambs should be implanted with 3 mg. of stilbestrol when they are started on feed. Antibiotics need not be fed except when lambs are under stress conditions (adverse weather). Consult your leader or farm advisor about new developments in feed additives.

### Other Important Facts

1. Keep salt available at all times.
2. Shear lambs at the beginning of feeding period.
3. Avoid overfeeding.
4. Do not feed moldy or spoiled feeds.
5. Feed at regular times.
6. Avoid sudden changes in feed.
7. In loading, unloading and moving sheep take care to avoid bruises and injury.

### Health and Disease Prevention

Enterotoxemia (overeating disease or pulpy kidney) may cause death losses in "good doing" lambs, or lambs on a high plane of nutrition. A vaccine is available—check with your veterinarian. Wet feedlots and pastures increase the danger of foot rot. Lambs' feet should be well trimmed in wet weather. Check with your veterinarian for treatment.

## Shelter and Equipment

Expensive buildings are not required for lamb feeding. An open shed or lean-to that is part of a general-purpose barn is advisable. Lambs need adequate room. Good feed bunks will pay for themselves in feed saved. Allow at least 18 inches of feeding space per lamb along the grain bunk. Plans for grain and hay troughs are available from your farm advisor.

Cover mineral and salt boxes to protect the contents from wind and rain.

# 4-H CLUB COMMERCIAL LAMB FATTENING PROJECT RECORD

Name \_\_\_\_\_ Age \_\_\_\_\_

Address \_\_\_\_\_ County \_\_\_\_\_

## Table 1 BEGINNING INFORMATION

Breed \_\_\_\_\_ Total number purchased \_\_\_\_\_

Date lambs purchased and project started \_\_\_\_\_

Average weight when purchased \_\_\_\_\_ Total weight when purchased \_\_\_\_\_

Purchase cost per cwt. \$ \_\_\_\_\_ Handling cost \$ \_\_\_\_\_ Total cost \$ \_\_\_\_\_

Individual identification of lambs and weights:

IDENTIFICATION	WEIGHT	GRADE
1. _____		
2. _____		
3. _____		
4. _____		
5. _____		
6. _____		
7. _____		
8. _____		
9. _____		
10. _____		

Purchased from \_\_\_\_\_

Describe *in detail* the system of feeding you plan to follow: \_\_\_\_\_

\_\_\_\_\_

\_\_\_\_\_

\_\_\_\_\_

\_\_\_\_\_

\_\_\_\_\_

**Table II**  
**OTHER EXPENSES IN ADDITION TO FEED COSTS**

Date	Item (Trucking, veterinary fees, commission, interest, insurance, etc.)	Amount	
Total \$			

**VISITS BY LEADERS**

Date	Visitors (Farm Advisor, leader, or others)	Remarks

**Table III**  
**FEEDING BUDGET (For one lamb)**

**DRY LOT – Pellets**

a) Cost of lamb \_\_\_\_\_ lbs. wt. x \_\_\_\_\_ ¢ per lb. a. \_\_\_\_\_

b) Cost of pellets – 4 lbs. per day x \_\_\_\_\_ ¢ per lbs. x \_\_\_\_\_ days on feed b. \_\_\_\_\_

c) **Miscellaneous costs**

\_\_\_\_\_ Veterinary fees +

\_\_\_\_\_ Trucking +

\_\_\_\_\_ Other costs = c. \_\_\_\_\_

**Total cost (a, b, and c)** \_\_\_\_\_

**DRY LOT – Grain and hay**

a) Cost of lamb \_\_\_\_\_ lbs. wt. x \_\_\_\_\_ ¢ per lb. a. \_\_\_\_\_

b) Cost of grain – 2 lbs. per day x \_\_\_\_\_ ¢ per lb. x \_\_\_\_\_ days on feed b. \_\_\_\_\_

c) Cost of hay – 2 lbs. per day x \_\_\_\_\_ ¢ per lb. x \_\_\_\_\_ days on feed c. \_\_\_\_\_

d) **Miscellaneous costs**

\_\_\_\_\_ Veterinary fees +

\_\_\_\_\_ Trucking +

\_\_\_\_\_ Other costs = d. \_\_\_\_\_

**Total cost (a, b, c, and d)** \_\_\_\_\_

**PASTURE AND SUPPLEMENT**

a) Cost of lamb \_\_\_\_\_ lbs. wt. x \_\_\_\_\_ ¢ per lb. a. \_\_\_\_\_

b) Cost of supplement – 1 lb. per day x \_\_\_\_\_ ¢ per lb. x \_\_\_\_\_ days on feed b. \_\_\_\_\_

c) Cost of pasture – 3¢ per day x \_\_\_\_\_ days on feed c. \_\_\_\_\_

d) **Miscellaneous costs**

\_\_\_\_\_ Veterinary fees +

\_\_\_\_\_ Trucking +

\_\_\_\_\_ Other costs = d. \_\_\_\_\_

**Total cost (a, b, c, and d)** \_\_\_\_\_



**Table IV**  
**CLOSING INFORMATION**

Date marketed \_\_\_\_\_ Days on feed \_\_\_\_\_

Final individual weights:

Identification	Weight
1. _____	6. _____
2. _____	7. _____
3. _____	8. _____
4. _____	9. _____
5. _____	10. _____

Final total weight \_\_\_\_\_ lbs.      Average weight per head \_\_\_\_\_ lbs.

Starting weight \_\_\_\_\_ lbs.      Average weight per head \_\_\_\_\_ lbs.

TOTAL GAIN \_\_\_\_\_ lbs.      AVERAGE GAIN \_\_\_\_\_ lbs.

Total gain divided by days on feed = \_\_\_\_\_ lbs. average daily gain

Total gain divided by total costs  
(Feed, labor, veterinary bills, etc.) = \$ \_\_\_\_\_ cost per pound of gain

Final grade for each animal \_\_\_\_\_  
\_\_\_\_\_  
\_\_\_\_\_

Selling price per cwt. \$ \_\_\_\_\_ Gross sale return \$ \_\_\_\_\_

**Table V**

1. Gross sale return of all lambs (Table IV)	\$ _____
2. Cost of all lambs at start (Table I)	\$ _____
3. Feed costs (Table II)	\$ _____
4. Other expense (Table IV)	\$ _____
5. Total expenses (Add lines 2, 3, and 4)	\$ _____
6. Net return from project (line 1 minus line 5)	\$ _____

# 4-H CLUB COMMERCIAL LAMB FATTENING PROJECT

## WEIGHT RECORD

Project owner \_\_\_\_\_

Weight period from: \_\_\_\_\_ to \_\_\_\_\_ head days \_\_\_\_\_  
(No. days x no. animals)

1. Number of head in project \_\_\_\_\_

2. Present total weight \_\_\_\_\_

3. Beginning total weight \_\_\_\_\_

4. Pounds gained \_\_\_\_\_  
(2 minus 3)

5. Average daily gain \_\_\_\_\_  
(4 divided by number days)

6. Total pounds grain used \_\_\_\_\_ cost \$ \_\_\_\_\_

7. Total pounds hay used \_\_\_\_\_ cost \$ \_\_\_\_\_

8. Other \_\_\_\_\_ cost \$ \_\_\_\_\_

9. Total pounds \_\_\_\_\_ 9a. Total cost \$ \_\_\_\_\_

10. Pounds feed per pound gain \_\_\_\_\_  
(9 divided by 4)

11. Cost per pound gain \_\_\_\_\_  
(9a. divided by 4)

-----  
12. Beginning total cost of animals \_\_\_\_\_

13. Cost of feed and miscellaneous used to present \_\_\_\_\_

14. Total present expenditures \_\_\_\_\_

Price per pound needed to break even \_\_\_\_\_  
(14 divided by 2)

Feed cost per day \_\_\_\_\_  
(9a divided by number days)

Feed used per day \_\_\_\_\_  
(9 divided by number days)

## SAMPLE APPLICATION FOR JUNIOR PROJECT LOAN

\_\_\_\_\_, California \_\_\_\_\_, 19\_\_\_\_

To \_\_\_\_\_ Office

I, \_\_\_\_\_, residing at \_\_\_\_\_

P.O. \_\_\_\_\_, County of \_\_\_\_\_, California, hereby

apply for a loan of \_\_\_\_\_ for a term of \_\_\_\_\_ with interest at \_\_\_\_\_ %,

payable \_\_\_\_\_ for the following purposes, to-wit:

1. To buy \_\_\_\_\_ head of \_\_\_\_\_ at \$ \_\_\_\_\_ per head.

2. To buy breeding stock as indicated below:

\_\_\_\_\_

3. To finance following crop production operations:

\_\_\_\_\_

My financial statement is as follows:

Assets		Liabilities	
a. Cash on hand or in bank	\$ _____	a. Notes and accounts payable	\$ _____
b. Accounts receivable (what others owe me)	\$ _____	b. Other liabilities (list)	
c. Market value of livestock owned	\$ _____	_____	\$ _____
d. Market value of crop products, feed, seed, supplies on hand	\$ _____	_____	\$ _____
e. Market value of real estate, buildings, equipment owned	\$ _____	_____	\$ _____
f. Cash surrender value of life insurance	\$ _____	_____	\$ _____
g. Stocks and bonds owned	\$ _____	<b>Total liabilities</b>	
		(subtotal)	\$ _____
h. Other assets (list)			
_____	\$ _____	My net worth is (total assets minus total liabilities)	\$ _____
_____	\$ _____		
<b>Total assets</b>	<b>\$ _____</b>	<b>Total liabilities and net worth</b>	<b>\$ _____</b>

A budget of my proposed operations follows:

**ESTIMATED RECEIPTS**

**ESTIMATED EXPENSES**

a. Product and byproduct sales list:		a. Purchase of stock	\$ _____
_____ \$ _____		b. Total feed needed	\$ _____
_____ \$ _____		c. Hired labor	\$ _____
_____ \$ _____		d. Seed and supplies	\$ _____
b. Miscellaneous credits (describe)		e. Equipment	\$ _____
_____ \$ _____		f. Rent	\$ _____
_____ \$ _____		g. Interest	\$ _____
_____ \$ _____		h. Miscellaneous	\$ _____
c. Value of closing inventory	\$ _____	i. Opening inventory	\$ _____
		TOTAL LABOR INCOME (total receipts	
d. TOTAL ESTIMATED RECEIPTS	\$ _____	minus total expenses) \$ _____	

Father's name \_\_\_\_\_ Father's business \_\_\_\_\_

Our farm consists of \_\_\_\_\_ acres and \_\_\_\_\_ head of livestock.

I am a student at \_\_\_\_\_. My age is \_\_\_\_\_ years. I will keep an accurate record of my project and will furnish a copy of the record at the end of the season for credit file in your bank.

Dated \_\_\_\_\_, Signed \_\_\_\_\_

**RECOMMENDATION OF 4-H CLUB LEADER**

I have known the applicant, \_\_\_\_\_, for \_\_\_\_\_ years and I recommend him for the loan requested. His record of completed projects follows:

Dated \_\_\_\_\_, Signed \_\_\_\_\_

4-H Club Leader

**APPROVAL OF PARENTS**

I have considered the project which my son/daughter desires to carry on under the supervision of the club leader mentioned above and I consider that he/she has the ability to carry it out successfully and repay the loan applied for herein.

Dated \_\_\_\_\_ and \_\_\_\_\_  
Father

or \_\_\_\_\_  
Mother

or \_\_\_\_\_  
Guardian



Pictures  
Record Book Insert

4-H Club Commercial Lamb Fattening Project Pictures and Clippings, 19\_\_\_\_\_ .

Include pictures of yourself and project. If possible, have the picture at the start and also at the end of the project. You may include pictures of other 4-H Club activities.

**4-H CLUB COMMERCIAL LAMB FATTENING PROJECT**

**Entry Form**

Date \_\_\_\_\_

Name \_\_\_\_\_ Year in 4-H \_\_\_\_\_

Address \_\_\_\_\_ Phone \_\_\_\_\_

Age (Jan. 1 this year) \_\_\_\_\_ Date of birth \_\_\_\_\_

4-H Club \_\_\_\_\_ County \_\_\_\_\_

Size of farm \_\_\_\_\_ acres Main crop \_\_\_\_\_

No. years you have carried a sheep project \_\_\_\_\_ No. animals desired for this project \_\_\_\_\_

**APPROVAL OF PROJECT ENTRY**

\_\_\_\_\_  
(Signature of parent or guardian) \_\_\_\_\_ Date \_\_\_\_\_

\_\_\_\_\_  
(Signature of project leader) \_\_\_\_\_ Date \_\_\_\_\_





AGRICULTURAL EXTENSION

UNIVERSITY OF CALIFORNIA

# 4-H CLUB SHEEP PROJECT MANUAL

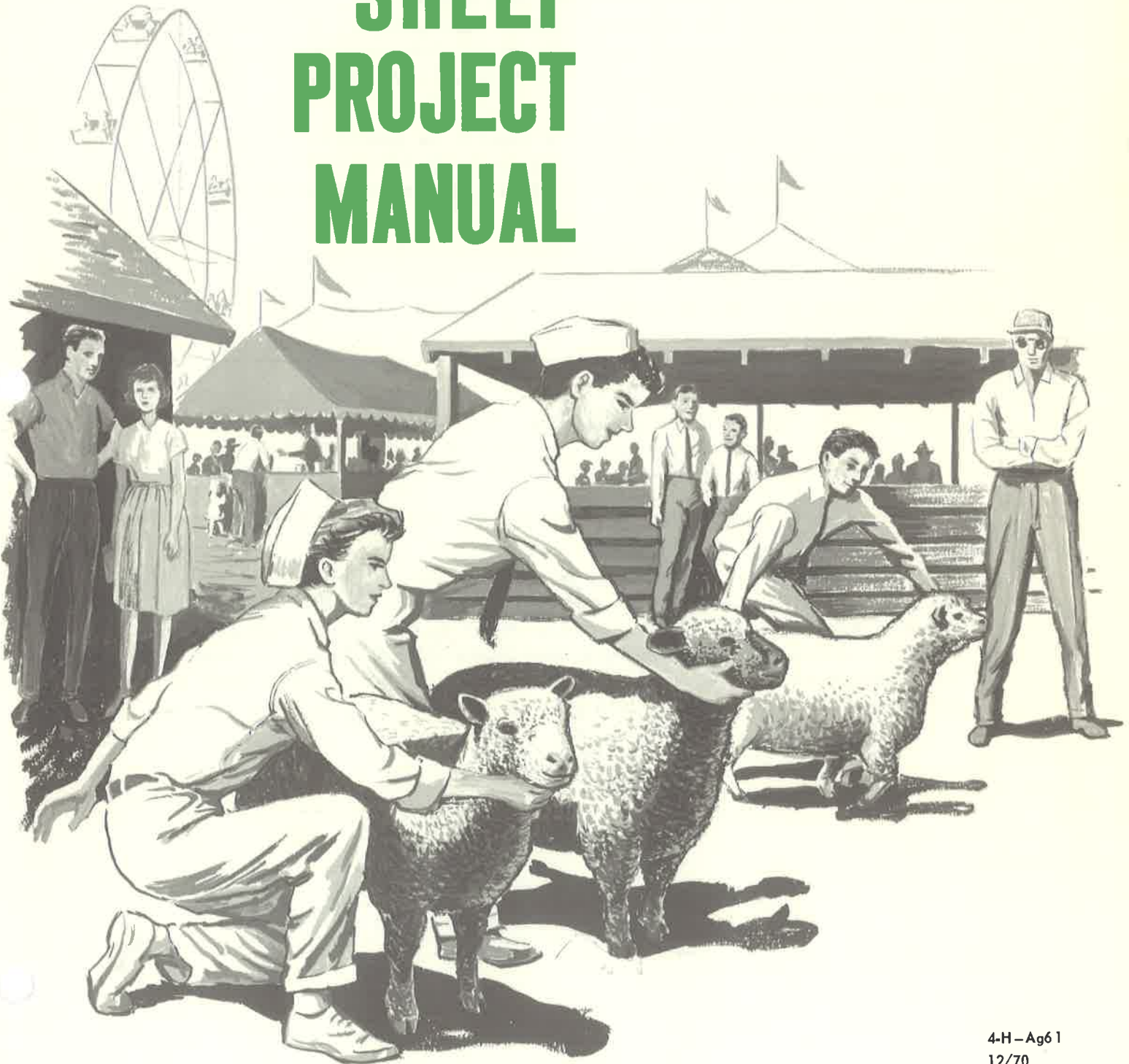

## P R E C A U T I O N S

Most insecticides are poisonous to man and other animals, particularly concentrates before they are diluted for application. Follow all precautions on the labels for their use and storage. **Read the label carefully!**

Do not allow waste and spillage from dipping and spraying procedures to drain into lakes or streams, since most insecticides are toxic to fish and other beneficial aquatic life. Livestock should be fenced off from pools or vats of insecticides to prevent their drinking the material. Before you dip livestock, it is recommended that you allow them to drink water. **Protect feed and water from contamination by insecticides.**

Current recommendations are contained in the publication, "*External Livestock Parasite Control*," issued each year by the University of California Agricultural Extension Service. This is available from your county farm and home advisors office.

For the sake of clarity, trade names have been used in some instances. This is not to be interpreted as an endorsement of a particular brand, nor is it intended to discriminate against similar products which are not mentioned by name.

*This publication was prepared by the State 4-H Meat Animal Committee of Extension Animal Scientist, Emeritus Reuben Albaugh and Agriculturist, Emeritus Horace T. Strong, 4-H Club Specialist A.D. Aulenbacher, and Farm Advisors Willard C. Lusk, Sonoma County, William B. Hight, Madera County, and S.W. Thurber, Lassen County. Original material on sheep feeding from project manual written by 4-H Club Specialist, Robert F. Davis, revised by Extension Animal Scientist Glenn Spurlock and 4-H Club Specialist John Emo.*

# SHEEP FEEDING

## STARTING YOUR PROJECT

You can have a lot of fun raising a lamb, and make some money, too, if you do a good job. Sheep produce two crops—meat and wool.

To raise a lamb, you have to learn how to feed him properly. There are several ways to start your lamb project. One of the easiest is to raise an orphan lamb, or “bummer.” Another way would be to buy a feeder lamb, 3 to 6 months old. You can learn most about feeding and caring for sheep by raising one yourself.

## SELECTING YOUR LAMB

If you decide to raise a bummer, perhaps your parents, leader, or farm advisor can help you find one. Every sheep ranch has extra twin lambs or orphans each year at



FIGURE 1. Bummer lambs are one way to start a sheep breeding project. They are not expensive to buy, but you will have to raise them a year before you can start breeding them.

lambing time. Sheepmen usually don't want to take time to raise them, and you often can get them for asking. From November to February is the best time to ask.

A lamb that doesn't get fat enough to sell before it is weaned is called a feeder. If you decide to raise a feeder, it will probably weigh between 55 and 70 pounds, and it can be either a ewe or wether lamb. Plan to feed the lamb for about 3 months before showing it at a fair or offering it for sale. If the lamb isn't already sheared, do this soon after you buy it.

Here are some points to look for if you decide on a feeder lamb:

White-faced range ewes that are bred to black-faced (meat-type) rams usually produce good feeder lambs. You often will find owners of flocks of Hampshires, Suffolks, Shropshires, or Southdowns who will have feeder lambs to sell.



FIGURE 2. A group of good fat crossbred market lambs. These lambs are the result of breeding a good black-face ram to a white-face ewe.

Purebred lambs, not necessarily registered, are excellent. If these are not available, try to get a lamb sired by a purebred meat-type ram.

It takes almost as much time to care for one lamb as for three or four. If you have the space it's a good idea to try to raise several. If you buy more than one, choose lambs that look as nearly alike as possible. Choose blocky, deep, wide, healthy animals. Sometimes club members cooperate in buying several lambs to be delivered at one place.

If you buy a 70-pound lamb and feed it wisely, it should gain at least 1/4 pound daily. This means it should weigh about 95 pounds after you have fed it for 100 days. Most healthy lambs will gain about 1/3 pound daily; some will gain faster.

### EQUIPMENT AND SHELTER

Lambs need less space and equipment than most animals. Green pasture helps lambs to grow fast and keeps feeding costs low. However, you can still do a good job of fattening a lamb in a pen. A 10- by 10-foot space is enough for 10 lambs.

For shelter give your lamb some kind of simple shed. Any building that is dry and



FIGURE 3. A good house for a small flock. This type will be ample in colder areas of the state. In most areas, however, a 3-sided open shed is ideal.

keeps out the wind will do. Some members build a shelter in the shade of a tree; others use a small building or part of one connected to a few feet of outside pen. Have the doorway or entrance facing away from prevailing winds and storms.

For feeding unweaned lambs, you'll need a lamb nipple for each one. They fit on any "pop" bottle. You'll need a trough and hay rack, too. For each lamb, allow about 1 foot of trough space and 1 foot of hay rack space. Troughs should be easy to clean, because your lambs won't eat dirty feed. You'll want a salt box, too.

For water you'll need a bucket. If you have more than one lamb, a simple watering trough will be handy. Clean the trough once a week. Keep fresh, cool water available for your lambs at all times.

For weighing grain, small scales are handy. Perhaps you can borrow a bathroom scale from the house to weigh your lambs every 2 weeks. Weigh yourself first. Then pick up the lamb and weigh the two of you together. Subtract your weight from the weight of you and the lamb. For larger lambs, hold them on their rump between your legs while you are standing on the scales.

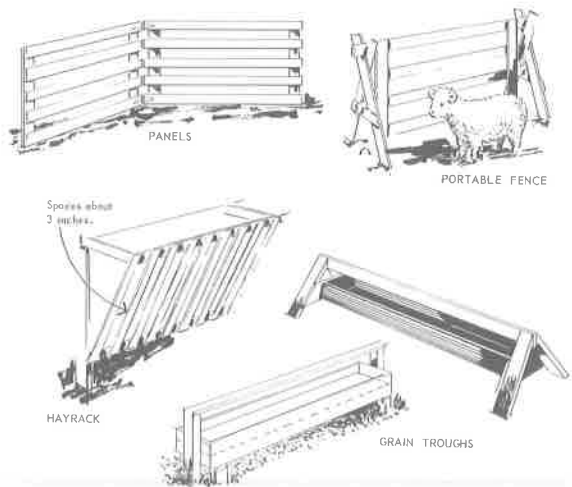

FIGURE 4. The tops of lamb troughs should be 10 to 12 inches off the ground. For ewes, the maximum height should be 16 inches.



**FIGURE 5.** To dock a lamb, hold it securely by both front and back feet, supported on a table or bench. Cut the tail with a quick downward motion. Disinfect the wound with tincture of iodine.

## DOCKING AND CASTRATING

When your lambs are about 2 weeks old, they should be docked and the males castrated. Docking means taking off the tail, and castrating is taking out the testicles. Castrated lambs are called wethers.

You can dock and castrate with just one tool—a sharp knife. Get your leader to help you the first time. Before you start, wash your knife and hands in hot soapy water, or, better yet, in a disinfectant solution, such as Lysol. Follow directions on the label for dilution. Cut off the tail between the second and third joints. Bleeding will be less if the operation is done on a cool morning.

Cut off the bottom third of the scrotal sack and pull out the testicles. Clip off any long strings of tissue hanging from the wound. Paint the wounds with iodine or pine-tar oil. University of California agricultural circulars will give you more information on these operations.

## MILK FEEDING

Everything your lamb uses should be kept clean—pens, bottles, feed boxes. Keep the nursing bottles extra clean. Wash them with hot water and soap and rinse them well after each feeding.



**FIGURE 6.** Test milk temperature on your arm.

The first milk a lamb gets from its mother is called colostrum. The colostrum contains antibodies that help the newborn lamb to fight infections. It is a laxative and gives the lamb vitamin A. Orphans often don't get any of this important first milk. You can give your orphan lamb 1 tablespoon of milk of magnesia and 1 tablespoon of codliver oil the first day to get him off to a good start. Bummer lambs will need less milk for energy and will remain healthier if kept in warm, snug quarters.

Lambs need whole milk. If you don't have a cow's milk, the next best thing is condensed milk mixed with an equal amount of water. When you have had the lamb about 2 weeks, you can gradually substitute 1 cup of nonfat dry milk mixed with 1 quart of water for the whole milk. For the first 3 weeks, add 2 drops of halibut liver oil or other vitamin A concentrate to the feed each day.

Feed your lamb at regular times, particularly at first. Your schedule will change as your lamb grows. We have worked out a milk feeding chart to guide you at first. You may find that your lamb needs a little more or a little less than is suggested, depending on his size. Later on, you can feed more, but your costs will increase.

## MILK FEEDING CHART

Age	When to feed	Feed this much each time	Feed this much every day
1-2 days	Every 2 hours 6 a.m. to 10 p.m.	3-5 tablespoons	1-1½ pints
3-4 days	Every 4 hours 6 a.m. to 10 p.m.	12-16 tablespoons	2-2½ pints
5-12 days	4 times a day: morn- ing, noon, evening, late night	1-1¼ cups	2-2½ pints
(Start grain feeding, see below.)			
3d week	Still 4 times a day	1-1¼ cups	2-2½ pints
4th week	3 times a day	¾-1⅓ pints	2-4 pints
5th and 6th weeks	3 times a day	¾-1⅓ pints	2-4 pints
7th and 8th weeks	3 times a day	¾-1⅓ pints	2-4 pints

Feed small, weak lambs somewhat less until they grow stronger.

### FEEDING GRAIN AND HAY

Your lamb will eat a little grain and hay at 2 or 3 weeks of age. A good feeder gets his lambs on feed early. There's a reason. It takes less feed for every pound of lamb you produce if you feed him well when he's young. Feed only a handful of grain to each lamb each day until he learns to eat. Feeders call this getting the lambs "on feed." Increase the feed a little each day until your lamb is eating ½ pound. At 2 months, he will eat up to ¾ pound daily.

A mixture of ½ each of rolled barley or cracked milo, whole oats, and wheat bran is good for a starter. As soon as your lamb is used to concentrate feeding (4 to 8 weeks of age), gradually switch to rolled barley or cracked corn alone. Each lamb will eat at least 100 pounds of concentrate by selling time.

Be sure your lamb has salt available and clean, cool, water twice a day.

Skim milk powder is cheaper than milk. When your lamb is 8 weeks old, you can change his feed by adding 1 pound of skim milk powder to each 5 pounds of mixed feed. Cut down the milk you are feeding a little each day, and give more grain and dry milk mix. Just be sure he cleans it up in 30 minutes, twice daily. It may be 4 or 5 weeks before your lamb will eat 1 to 1½ pounds of grain

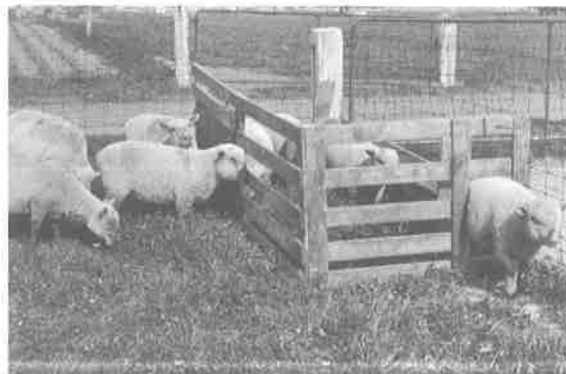

FIGURE 7. A lamb creep in the field. These fat well fed lambs show the advantage that comes from having their grain where ewes cannot reach it.

mixture each day. If you start feeding the grain mixture too quickly, your lambs may go "off feed" and begin to scour. **Don't overfeed.** Watch the droppings. If they are firm and separate, they're all right. When they are soft and sticky, cut the amount you feed right away.

Your lambs will nibble a little green leafy alfalfa hay at 2 weeks or earlier. Give them a little more each day. Just be sure they clean up all the leaves. You can feed up to 2 pounds a day when your lambs weigh 50 to 60 pounds. When they get that big they are feeder lambs.

Along with green, leafy alfalfa hay, a single grain, fed whole, rolled, or coarsely cracked, usually is sufficient for weaned lambs. Corn, milo, or barley are used commonly. When cereal hay is fed, it is well to add 10 per cent by weight of linseed or cottonseed meal as a source of protein to go with the grain ration.

#### Points to Remember:

- Provide fresh hay twice daily.
- Start grain feeding slowly, twice a day.
- When on full feed, give the lambs all they will clean up.
- Keep the feed trough clean.
- Feed regularly, early in the morning and again late in the afternoon, at times when the weather is cooler rather than in the middle of the day.
- Keep pen clean and dry, with enough bedding.
- Do not make sudden changes in feed.
- Keep fresh, cool water before the lamb.
- Keep salt before the lamb.

## MARKETING

During the entire feeding period, keep the selling date in mind. You are working to have the lambs fat and weighing from 85 to 100 pounds by then. When deciding where to sell, investigate all possibilities, including club sales, auctions at county fairs, packer buyers, neighbors who buy meat for their lockers, and others.

If the lambs you raise are purebreds, perhaps you can sell them to local farmers and other 4-H Club members. You may be able to sell breeding animals at breeder sales in your area. Clean and trim your animals before you offer them for sale. If they look their best, they probably will sell for more money.

## PESTS AND DISEASES

If your lamb gets sick, talk with your veterinarian. He will know what is wrong and how to treat it. You can make simple treatments yourself, but ask your parents, leader, or other experienced person to help you the first time.

**Round worms or stomach worms** are very common in sheep. One of the most satisfactory ways to treat them is to use thiabendazole drench. Drenching refers to giving medicine by mouth. Follow directions on the label for mixing. Treat your sheep when you first buy them. Treat them again every 3 or 4 months if kept on irrigated pasture.

**Maggots and screw worms** are hatched from flies that lay eggs. Blow flies are attracted by manure and filth on the wool. To help protect your sheep, keep them well tagged. Keep the hind parts clean by cutting off tag ends that have an accumulation of manure.

The screw worm fly is attracted by fresh wounds. During fly season, watch all fresh wounds on your sheep to protect them from this pest.

For both types of maggots, a preparation called EQ335 works very well. Clean the area thoroughly and apply according to directions.

**Lice and ticks** can be controlled with lindane. Follow the directions on the package for preparing dip. Carefully and thoroughly soak the wool to the skin, all over the body.

**Scours** is most common in baby lambs, particularly if they have been chilled. If a baby lamb is born in filthy surroundings, or if his mother has not been properly tagged, he picks up large numbers of barnyard bacteria by way of mouth. If this happens, he will show signs of weakness and lose his appetite when he is 3 to 5 days old, and he may die soon. If this disease starts in a flock of lambing ewes, it may continue throughout the lambing season. Your veterinarian may prescribe antibiotics for treatment. The best way to prevent this disease is to keep your sheep and their surroundings very clean.

**Navel ill or joint ill** begins with an infection of the umbilical cord at birth. The infection may travel to the liver and cause abscesses, or it may go to the joints and cause arthritis. The best way to prevent this disease is to have the ewe lamb in as clean surroundings as possible, and treat the navels of newborn lambs with iodine, as described in the section on lambing.

**Foot rot** often occurs when the feet are not properly trimmed. Inspect the feet of your sheep every 2 or 3 months, and trim away the excess wall and toe. To treat foot rot, trim away all diseased and excess horny tissue. Then treat with a footbath, such as a 10 per cent solution of bluestone (copper sulfate). Do not get the solution on the wool. Repeat the treatment every 2 or 3 days until the animal is well. Copper sulfate is a poison, so handle it carefully. Be sure not to leave solutions or the crystals around where animals can eat them. Keep the affected animal separated from the rest of the flock until it is entirely healed, because foot rot is a highly contagious disease that spreads easily from infected animals to clean ones.



# SHEEP BREEDING

## PLANNING YOUR PROJECT

Before you start a breeding project, you should have raised a 4-H lamb. You will already know something about caring for sheep, and something about the business of raising livestock too.

When you have a breeding project, you are in the real business of raising sheep. You have greater risks, but you have the added satisfaction of watching your flock increase.

Decide what kind of breeding project you will have—will you breed for market lambs or for replacement breeding stock? Choose the kind of breeding project that will be most successful for your purpose. If you want to produce market lambs by crossing a purebred buck to a range ewe, choose your buck carefully so you will get early, fast-growing fat lambs. If you are going to deal in purebred stock, decide what breed is best for your purpose. Because of the higher cost per head, and since most beginners lack experience, you would be wise to start your breeding flock with grade animals while you are learning the business.

## CHOOSING THE BREED

Your animal must be typical of the breed you select. Breeds fall into two general types.

**Meat types** produce fast-growing meaty lambs. Hampshire, Shropshire, Southdown, and Suffolk are of this type. Most meat-type sheep have black faces. You can use one of these or a cross of black-face breeds to produce market lambs.

**White-face** or dual-purpose sheep produce a more valuable crop of wool than the meat types, but the lambs of some breeds are less desirable for market. If you crossbreed a white-face ewe with a meat-type ram, you will get a desirable market lamb, and the wool from the ewe will be worth more money.

Breeds of the white-face type are Rambouillet, Corriedale, and Columbia. All are found in California. If you produce crossbred black-face lambs for market, you should not use any of the lambs for replacements in your breeding flock. You should buy new breeding ewes to replace old ewes and to expand your flock.

If this is your first sheep project, you may be wise to start with good quality grade animals—until you have gained experience. There are many advantages to raising grade sheep. Your investment is much less—you often can get a grade ewe for very little money. You may make more money for your investment with a grade market lamb.

Purebred sheep are more expensive to buy, but, over a long period of time (with careful breeding and management practices), you can improve your flock and get a bigger return for your high quality animal. However, it may take years to develop a clientele of buyers.

If you are interested in purebred stock, find out what breed is the most common in your community. You are more likely to sell the surplus breeding animals that you raise if you have the same breed. Also, you will find it easier to get your ewes bred if there are purebred rams of the same breed in your community.



(A)

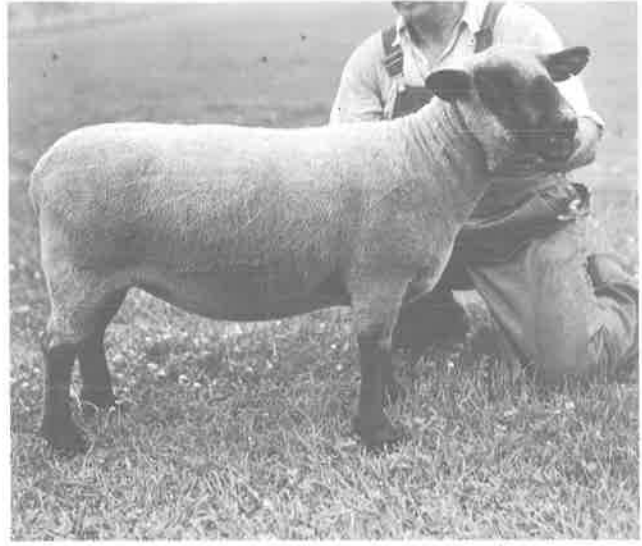

(B)

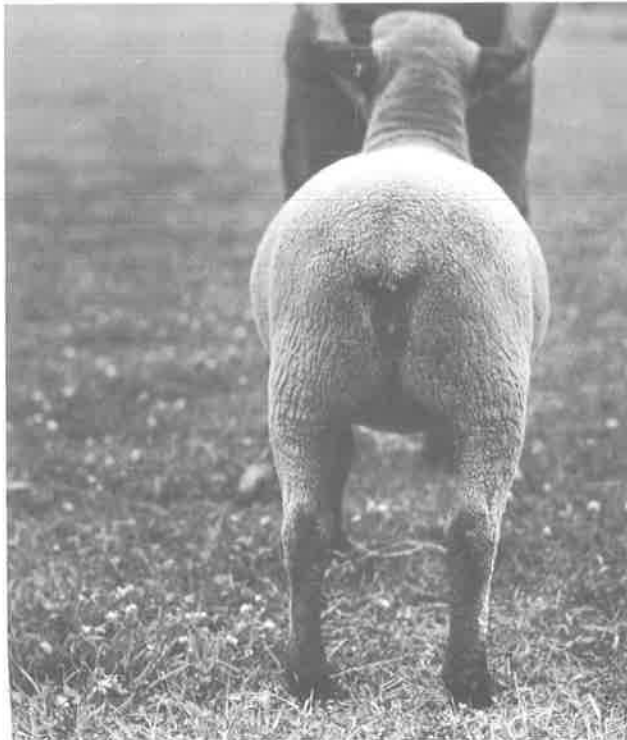

(A)

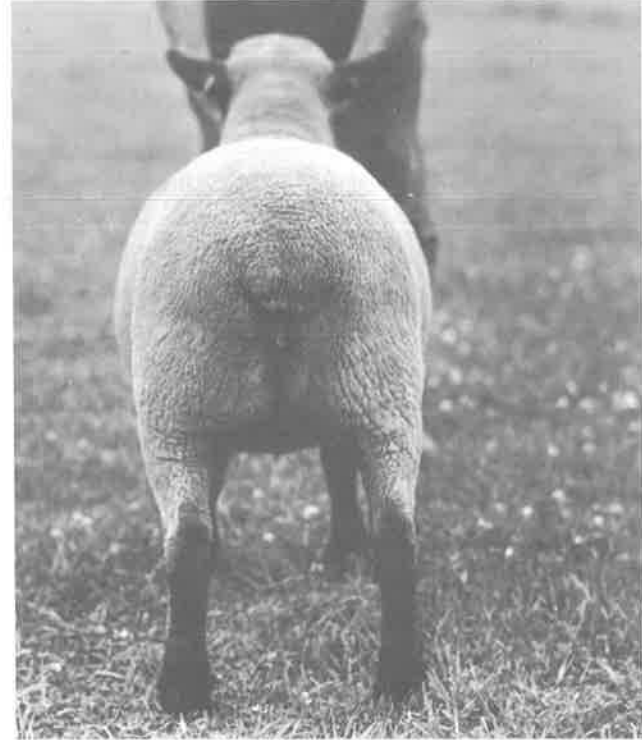

(B)

**FIGURE 8.** Learn to recognize good animals. The ewe on the right (B) is the better animal. It has shorter legs, thicker hind quarters, a shorter neck, and is generally more compact.

Purebred sheep need special attention at breeding and lambing time. You must be present to see that the right ram is bred to the right ewe. At lambing time you must get the records for pedigree papers. You will need to give the lambs special care, because you cannot afford to lose even one purebred lamb unnecessarily—your investment is too high. You will need separate pens or fields to keep your rams and ewes apart when you are not breeding them.

### CHOOSING YOUR EWE

Breeding ewes, of any breed, should be large and deep bodied; they should be deep and thick, with straight body lines and should show a capacity for feed. An ideal breeding ewe should also have a refined head, short neck, and smooth shoulders. A ewe should be free from wool around the eyes to avoid wool blindness—she must be able to see to find food to help her grow vigorously and provide proper nourishment for her lamb. Her wool should be dense, long-stapled and typical of the breed in fineness.

Ask an experienced reliable breeder or your 4-H Club leader to help you select the right kind of animal. There are three good sources for obtaining breeding ewes.

**Older bred ewes** from a high quality grade or purebred flock often can be purchased at moderate cost. Of course, the purebred ewe will cost considerably more than the grade ewe. Be sure the ewe you buy has a sound udder and a full mouth (a full set of teeth). The teeth should not be long and loose in the gums.

**Yearling ewes** are ready to breed, and they have a long productive life before them. They often are more expensive, but you have

the advantage of a better selection of young quality ewes. They do require more attention at lambing time.

**Bummer or orphan lambs** often can be obtained from a flock for very little cost. These lambs require considerable time and attention if they are properly started and grown. However, if you raised ewe lambs in your sheep feeding project the first year, you might use them to start your sheep breeding project.

### EQUIPMENT AND SHELTER

The equipment needed for your sheep breeding project depends somewhat on the number of animals you will have.

**For shelter** you might use a shed closed on three sides, with the open side protected from wind and rain. A small barn is excellent, if it is available. If you live in a very hot area, plan to provide adequate shade for your sheep. You can use wooden panels or woven wire to enclose small pens. Fencing around the pastures needs to be “sheep tight” before you turn your animals into the fields. If you live in a neighborhood where dogs are a problem, you may need dogproof fencing.

**For feeding** you will need troughs for feeding concentrates. Place them at a convenient height off the ground and protect them from rain and wind. You also will need a rack for feeding hay. An available supply of hay is necessary. You will use it as a supplement to pasture and range.

You must have enough pasture or range to take care of your breeding ewes during the year. If you depend entirely on harvested feed, it is doubtful if you can make a profit on the breeding project. For every 5 sheep, you should provide at least 1 acre of irrigated pasture or 5 acres of rangeland.

Other equipment needed will include rope halters, trimming table, brush, shears, and clippers for fitting and trimming lambs for show. Additional supplies should include disinfectant solutions and fly repellent.

### FEEDING YOUR EWE

If you have plenty of good pasture, you will not need to feed any additional grain or hay to the bred ewe until lambing time. Provide her with free-choice salt. After she has her lamb, if the pasture is not the best, you can give her  $\frac{1}{2}$  to  $\frac{3}{4}$  pound of grain per day, plus

pasture or plenty of good quality alfalfa hay. You can use whole barley, milo, or corn.

A 10-day-old lamb can be started on a little grain and leafy hay. For lambs under 7 weeks, use grain in the ground form. Be sure to clean out the feed trough every day. After 7 weeks, you can gradually change the feed to whole grain. Lambs can be fed grain in a creep.

Take the ewes off grain about 6 weeks after lambing if the ewes and lambs are on good pasture. Provide plenty of fresh water and salt at all times.



FIGURE 9. You will enjoy your breeding project. The ewe in this picture is a good breeder with twinning ability. She is a desirable type of ewe to have in your project.

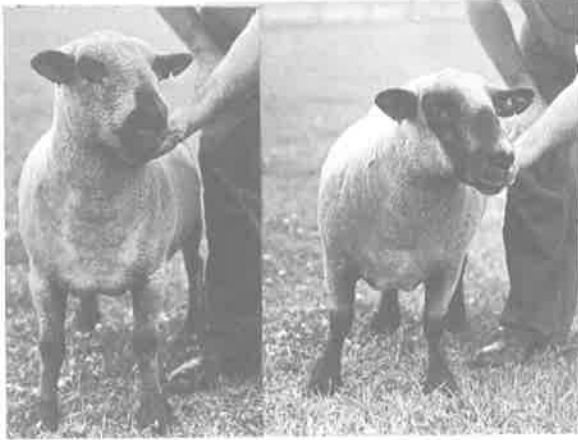

FIGURE 10. Ewes may differ markedly within a breed. Here the better ewe is on the right side. She has shorter legs and neck and is more compact.

## BREEDING YOUR EWE

The proper time for breeding your ewe varies in different areas of the state. In most areas you will want your ewe to drop her lamb as early in the fall or winter as possible. This means that your ewe should be bred during the summer months—from June to September. White-face sheep generally breed earlier than meat-type or black-face sheep. Often the black-face breed will not come in heat until August or September.

Feed your ewes extra well for 2 weeks before breeding, so they will be in good condition and gaining weight at the time they are bred. The gestation period for sheep is 5 months.

Unless you have your own ram, you will need the services of a high grading purebred sire. The breeder who sold you your ewe may be willing to provide breeding service. Get the services of the best ram possible.

It is desirable to provide the ram with a marking harness, so you can tell when the ewe has been bred. A marking harness is a device that can be strapped onto the ram so that each ewe bred will show a chalk mark

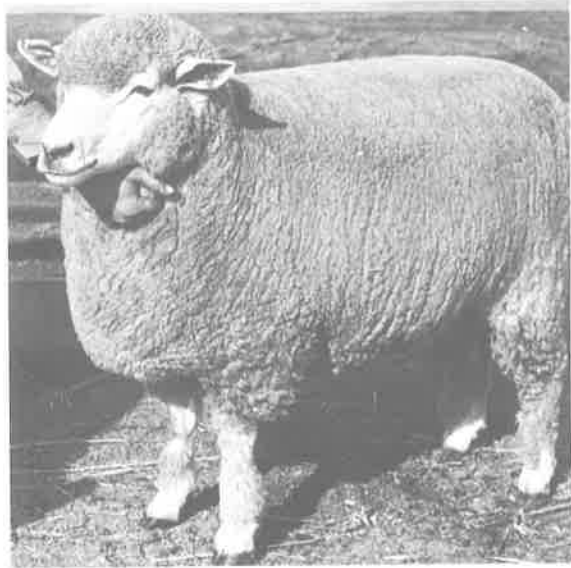

FIGURE 11. An excellent breeding ewe. Note her straight body lines, and even, dense fleece. She has a large open face and ample bone structure in the feet and legs.

on her rump. Occasionally, individual rams are sterile. A flock should never be bred to one ram alone unless this device or a similar one is used for marking the ewes. The chalk should be changed to another color each 3 weeks, so that those ewes that do not conceive at the first breeding can be noted as “repeaters.” This allows you to use another ram while there is still time.

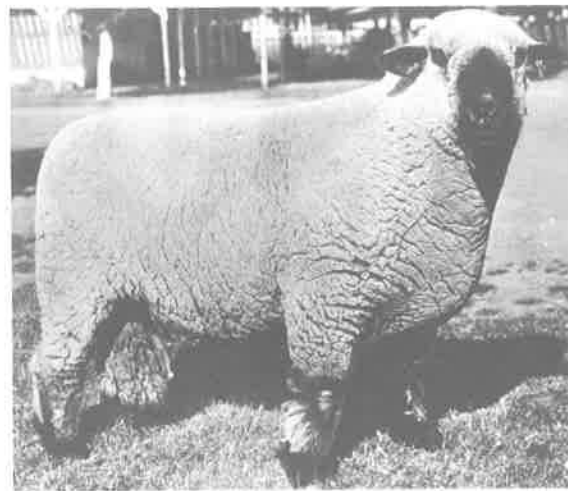

FIGURE 12. This Hampshire ram is a good specimen of a mature breeding sire. He has a deep, smooth body and is short legged, rugged, masculine, and alert.

## LAMBING

A short time before your ewe is expected to lamb, shear the wool from around her udder and flanks, between the hind legs, and over the dock. This is called "tagging."

During lambing, do not disturb the ewe any more than necessary. If she has trouble lambing, get the help of someone who is experienced in lambing problems. It may be necessary to call a veterinarian.

After the lamb is born, wipe the mucus from its nostrils and mouth. Open both the ewe's teats by milking a little from each one. If the lamb is chilled, wrap it in a warm sack or put it under a heat lamp in the pen with the mother, if possible, so she can smell it and become acquainted with it. As a last resort, you can soak the lamb in a bucket or tub of warm water, up to the level of its head. To keep the lamb from drowning, you can tie a stick to each side of its neck behind the ears, and support them on the edge of the bucket. The water should be as warm as your hand can stand.

After the lamb has been revived, it can be fed and dried and returned to its mother.

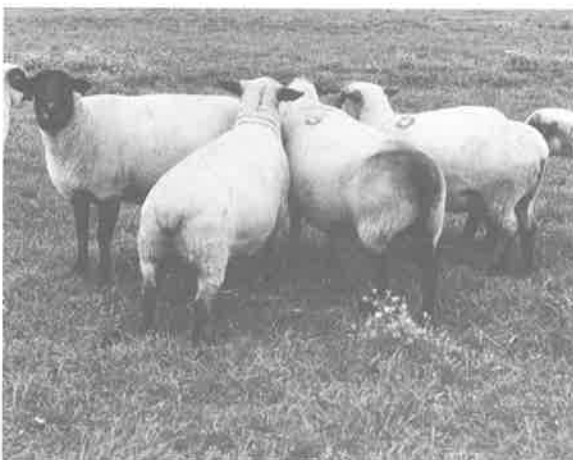

FIGURE 13. The ewe at right center has recently been bred by a ram that has been marked between his front legs. With this method you can detect when the ewes are bred and thus you can keep an accurate record and prepare better for lambing time.

Usually, the ewe will no longer own her lamb. In such case, you must tie her by the neck to the side of the pen until she will claim her lamb.

Keep the lambing quarters as clean as possible and well bedded with dry straw. To prevent navel ill or similar infections, it is most important that you clip off the umbilical cord of the newborn lamb with a pair of scissors, about 1 inch from the belly, and paint the stub and surrounding area with tincture of iodine.

One common problem among newborn lambs is "pinning." Lambs that nurse ewes that give a lot of milk may suffer from feces collecting and drying under the tail. Such lambs cannot defecate properly and they get sick. To relieve the trouble, carefully scrape the material off with a stick.

Another problem is "entropion." The eyelids of the lamb turn in so that the eyelashes rub against the eyeball. Blindness can result. To correct this trouble, pinch off a small bit of the skin below the lid with a pair of scissors. The remaining scar will shrink and hold the eyelid in proper position.

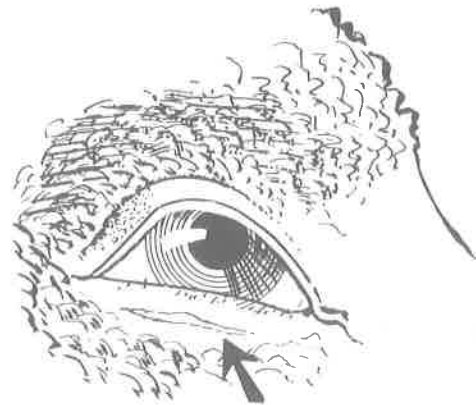

FIGURE 14. Arrow points to section of skin to be removed.

## GOOD MANAGEMENT PAYS

The care and management practices you follow can make your project successful. Careful attention to the needs of your animals is essential. Do what is needed in the right way at the right time.

**Docking and castrating** usually are done when your lamb is 2–3 weeks old. If you are going to market the male lambs as fat or feeder lambs, castrate them at the same time that you dock. See the section on docking and castrating for further instructions (page 3).

**Identification and registration** are important, too. If your lambs are eligible for registration, contact your breed association for application forms and identification tags. Lambs can be marked with a tag, ear tattoo, ear notch, or brand, so that you can keep a record of each lamb.

**Parasites and diseases** often can be controlled by simple treatments you do yourself. But ask your parents, club leader, or other experienced person to help you the first time. If your animal becomes sick, talk to a veterinarian. See the section on sheep feeding for more information.

**Shearing** is sometimes a problem. You may arrange to take your sheep to a nearby ranch where a shearing crew is working. Shear your ewes in the spring before warm weather starts. Feeder lambs that are kept through the summer for fall market also will gain better if they are shorn. In some areas it is a general practice to shear in the fall as well as in the spring.

# SHEEP SHOWING

## PLAN FOR SHOWING

You will want your show sheep to make a good appearance and be gentle. To look their best, they must be well mannered, carefully groomed, and properly shown. You must begin your preparation early. The more sheep you plan to show, the earlier you should begin giving special attention to their feed and care and grooming. Start fitting about 10 weeks ahead of showing.

Breeding sheep show best with long fleece. If you have fat lambs, you probably will shear their backs about 2 months before the show. This makes blocking easier and also helps keep the lambs cool. Frequent trimmings help give the animals the appearance you want them to have.

## SELECTING YOUR SHOW SHEEP

Before planning to enter your sheep at a fair or show, check to make sure there is a class in which your sheep can enter.

If you have several sheep, select the animals that come closest to the ideal breed type as your show animals. The breed associations set up standards for each of the main sheep breeds. Each association also prepares photographs or drawings showing the top animals of that breed. You or your leader can get these without charge by writing to the association for your breed of sheep.

The meat breeds (those raised chiefly for market lamb production) usually are lowset, compact, thick, and heavily muscled. They have wide, level backs, deep full ribs, thick thighs, smooth shoulders, and general fullness of outline. The neck is short, full, and smooth at the shoulders, neat at the throat, and somewhat arched. The head is broad and neatly carried. Straight legs with ample bone, placed squarely under the body, and strong pasterns are typical of good animals.

Some animals are undesirable for showing because of thinness, sway backs, crooked legs, dark fibers, blue skin, scurs, weak pasterns, weak shoulders, or ugly heads.

#### EQUIPMENT YOU WILL NEED

To prepare your sheep for showing, you'll need some tools. A medium-fine fiber brush or a round spring curry comb will help you clean the sheep's fleece. You also can use

the brush to dampen the wool with a water-dip solution, made by adding 2 tablespoons of coal-tar dip to 1 gallon of water. Use the solution sparingly.

With a wool card, you can pull up and even out the tips of the wool so that it can be cut evenly with the shears. When the card becomes full of wool, clean it with a brush or an old table fork with the prongs bent at a 1-inch right angle.

Use good sharp shears on the wool to get a smooth, even appearance. You'll be able to use the shears better with practice. Use knives or pruning shears to trim the horny part of the hoof. If the feet are soft, a pocket knife may do as well. Do not cut toward yourself.

You'll also need a double-loop halter 10 feet long, made from  $\frac{1}{4}$ -inch or  $\frac{3}{8}$ -inch three-ply rope, cotton bag to make a sheep blanket (burlap sheds fibers into the fleece and damages it for manufacturing purposes), and trimming table.



- SHOW BOX
- SHEEP DIP
- SPRAY FOR WATER  
OR SHEEP DIP
- BUCKET
- WHETSTONE
- BODY CARD
- CARD FOR HEAD,  
LEGS, AND FACE
- BRUSH
- FOOT CLIPPERS
- CLIPPERS
- BENT FORK FOR  
CLEANING THE  
CARDS

FIGURE 15. Equipment used to prepare sheep for showing.



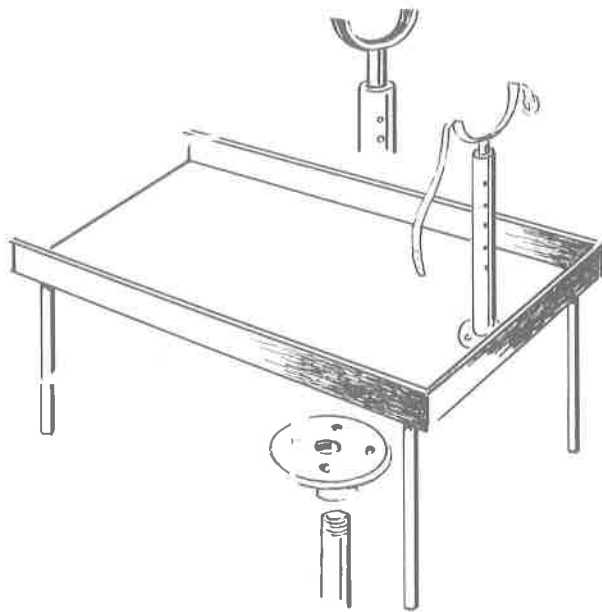

FIGURE 16. This fitting table is 24" high. The platform is 23" by 43". Strips on front and sides keep animal from sliding off. Yoke screws into pipe stand on top and can be raised or lowered. Legs screw into pipe stands on bottom.

## BLOCKING YOUR SHEEP

Blocking is trimming your sheep to make them appear as attractive as possible. You will acquire skill with practice and patience. Practice blocking on your poorer sheep.

The amount of trimming or blocking you do will depend on the type of sheep you have. On the long-wool breeds, cut off only a few tag ends where needed, leaving the fleece in its natural condition. Lambs are not shorn; show your yearlings carrying 10 to 12 months of fleece.

Trim most mutton-type breeds, such as Suffolk, Hampshire, Shropshire, and Southdown. Yearling ewes and rams should have 6 to 8 months' growth of fleece to show to best advantage. These sheep are shorn early in the spring or preceding fall; then they will have plenty of wool for you to do a good job of trimming. Do not shear lambs to be shown in breeding classes. Lambs to be entered in fat lamb classes should be shorn at weaning time, or within 60 to 90 days before the show.



FIGURE 17. Trim your sheep's feet so that he can stand evenly. Uneven feet interfere with his foraging and may become diseased.

When you start blocking, keep in mind the characteristics that distinguish your breed from all others. Remember the breed association's model of perfection as you carefully examine your sheep. Is yours pinched in the heart girth, high in the shoulders, low in the back, or cut up in the twist? Keep these faults in mind as you try to make your animal conform to the ideal pattern.

**First, trim the feet** so that your sheep stand evenly and well up on their toes. If the feet are not kept trimmed, they become filled with dirt, rocks, and filth. This gives your animals a broken-down appearance, and might make them lame.

To trim the hoofs, set your sheep on its rump and brace its back with your legs, so you can reach all four feet. Trim the outside horn so that it is nearly level with the sole. Don't cut too deeply. Examine your sheep's feet often.

**Next, use the brush.** Tie the sheep with a rope halter. Better yet, fasten it in a trimming table so the head is held in a normal position. The sheep will stand more readily in a natural position on a trimming table than it will in halter. Dip your brush into the mild dip solution, shake out well, and vigorously brush the wool until all bits and particles of material are removed. You may have to wash dung-covered locks with soap or sheep-dip solution.

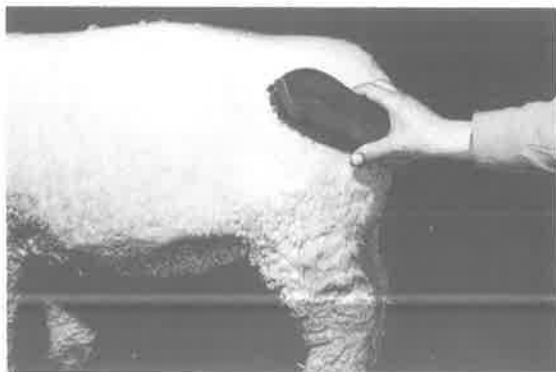

FIGURE 18. Brush all dirt from the wool.

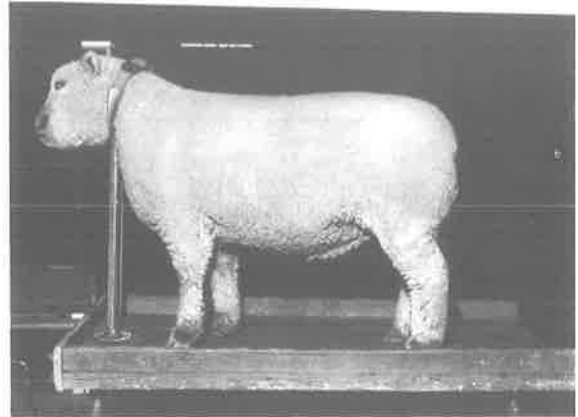

FIGURE 19. Sheep on platform ready for clipping.

**Then begin to shear.** Use your card to pull up the wool fibers so they can be cut evenly. Pat the card firmly into the wool and remove it by pulling upward with a twisting motion of your wrist. While carding, remember to keep the wool damp, but not soaking. Kneel at the rear of your animal and begin "cutting down" the back wool from a point on the top of the hips to the shoulders. Hold your shears flat against the body. Practice holding the bottom blade still and making the top blade do the cutting. Repeat the carding and trimming until the back is level and broad. Be careful not to cut too deeply in any one place. Leave at least  $\frac{3}{4}$  inch of wool on the back of breeding sheep. On fat lambs, trim the wool closer. Short wool makes the back feel firmer.

**Trim the right side** of the sheep in the same manner. Try to make your animal appear wide from front to rear, with a deep lowset body. Trim only enough wool from the belly to even the underside.

**Now trim the left side.** Move to the front and left of your animal. Dampen the fleece, card up, and trim off the fuzz ends.

**Trim the rump** so that it is straight and level. Square the dock to show width and plumpness, and trim the leg of mutton to give a full appearance.

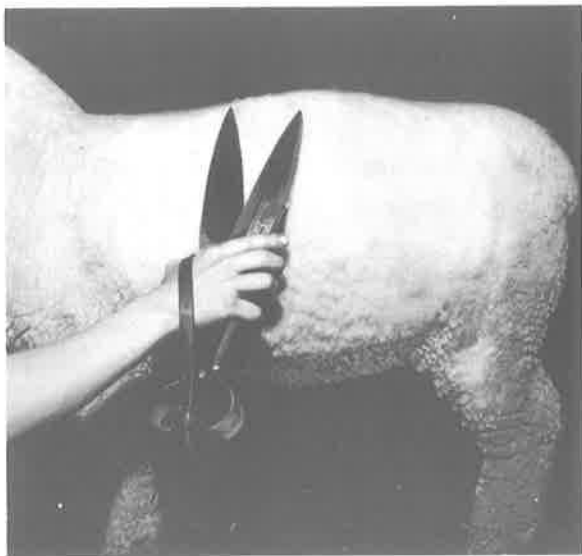

FIGURE 20. Hold shears flat against the body when trimming sides.



FIGURE 21. Carding the wool.

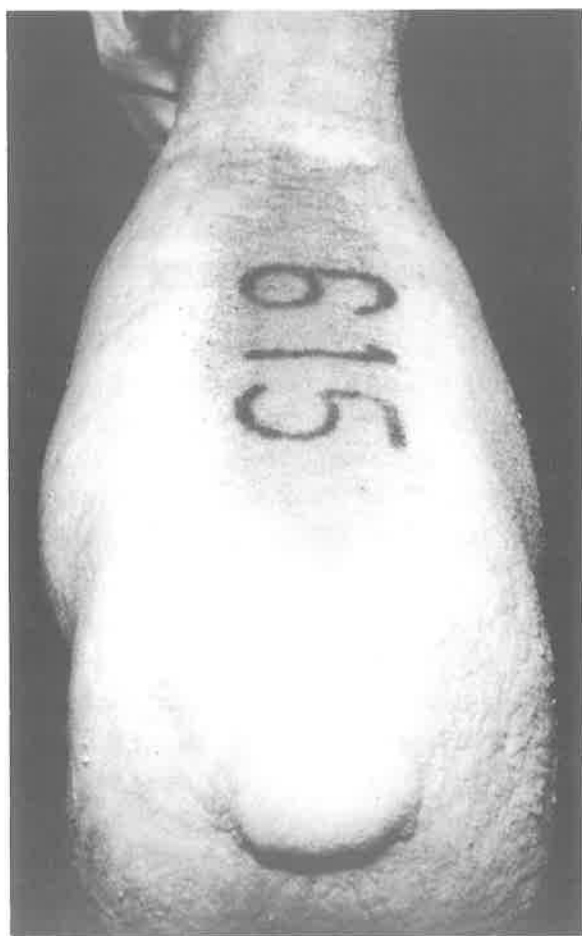

FIGURE 22. Top view of sheep after trimming.

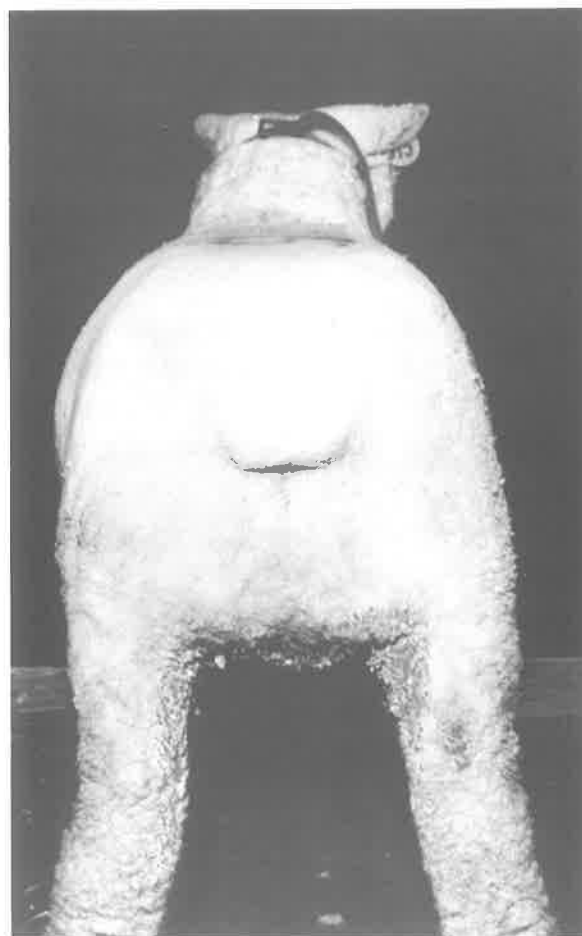

FIGURE 23. The rear of the sheep after trimming.



FIGURE 24. Trimmed head.

Trim the head to conform to the breed association's standards. The head and neck should blend smoothly into the shoulders.

### PACKING AND BLANKETING

After you have blocked the sheep, you can improve the appearance and feel of the fleece by lightly patting it with the back of the card. This has the effect of packing the fleece. After trimming, fit your sheep with a blanket, but make sure it does not cut into the wool. Keep your sheep dry. Heavy rains will wash the yolk, or oil, out of the wool, destroying the luster and bright, healthy appearance of the fleece.

You can make blankets from cotton sacks or light canvas. Remove the seam along the side and one corner of the sewed end, as



FIGURE 25. Sheep with a blanket made from a sack. This is the type commonly used, but burlap is not recommended.

shown in the diagram. Cut along the black line. Fasten the blanket to the rear legs with cords placed at A and B. The blanket helps to keep the fleece clean and compact. Never use burlap, since burlap fibers damage the fleece for manufacturing.

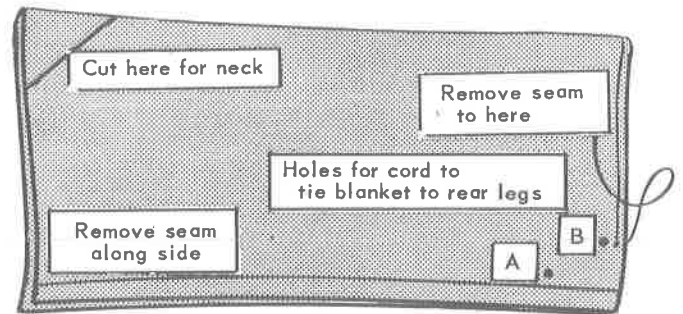

### HANDLE YOUR SHEEP CAREFULLY

To make catching and handling easier, confine your show sheep in a small shed or lot. This also keeps the sheep from over-exerting.

Do not catch sheep by their wool. Rough handling by the wool causes bruise spots on the carcass. The best place to catch a sheep is by the jaw or flank. Young animals are easily caught by the rear flank with the full hand. Without pinching, pull upward as if you intended to lift the rear end off the ground. To catch larger, more unruly sheep, place one hand well forward under the jaw, and the other behind the head on the neck.

When moving your animal, place the left hand under the jaw, grasping some of the wool if necessary. Place your right hand on the dock. By gently applying pressure to the dock and guiding your animal with your left hand, you can move it easily. Learn to move your animal with the least apparent effort. Work with your sheep until it can be easily posed and will not become excited when handled by the judge. Some animals are more excitable than others.

Your sheep need daily exercise to keep them healthy. Rest is also important to your sheep. After a long journey, it is better to leave the animal undisturbed if it does not wish to eat.

## SHOWING

On show day there is much to be done. In addition to feeding and watering animals and cleaning pens, there are final touches to be given to your sheep. Be ready early, and stay by your animal. If you are late, the class will be judged without you and your sheep will not be shown.

You are in the ring to show your sheep—set him up and keep showing him all the time you are there. Pay close attention to the judge and follow his instructions promptly. When he asks you to move your animal

up or down the line, move into the new position from behind the line and continue to show your animal. Always keep your animal between you and the judge. Keep your animal from coming in contact with other animals that are being shown. Be prepared to answer questions courteously and promptly.

If your sheep wins, accept congratulations modestly. Allow your animal to wear the ribbon. If you lose, congratulate the winners. Never lose your temper or grumble at your animal, the judge, or other showmen. Retire from the ring after the placings are made and entered in the judging book.

Whether you win or lose, you have learned more about showing and judging—and that is the main reason for your taking part.



FIGURE 26. A prize-winning sheep should be well mannered, carefully groomed and properly shown.

## YOUR RESPONSIBILITIES AT THE SHOW

- Keep your alleys clean and free from feed, show boxes, and equipment. If the alleyways around your pens are dirt, rake them often and dampen them to keep down the dust.
- Keep your pens clean and bedded with straw. Your animal's comfort is your first consideration.
- Both you and your animal should be clean and well groomed. As an exhibitor, you should be neat and a credit to the 4-H Clubs of your community.
- Be courteous to all. Don't take part in roughhousing.
- If you have no entries in a class, but your fellow members do, help them with their showing. Help younger members who are exhibiting for the first time.
- If you spend your free time discussing feeding and management practices with sheepmen and judges, you will increase your knowledge. If you spend your free time at the midway, you will increase your expenses.







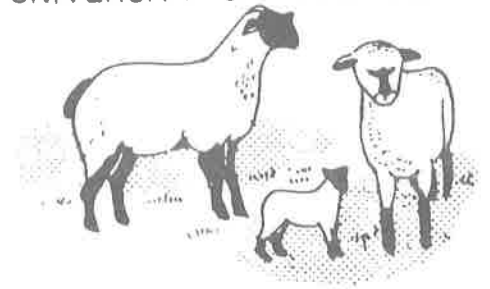

# 4-H Sheep Project

## MEMBER'S GUIDE

---

When a 4-H member enrolls in the sheep project he/she will be learning about one of Agriculture's most dynamic industries. Each year the member should gain more knowledge and broaden his/her experiences. The 4-H member should have a thorough understanding of the world's oldest animal agricultural industry. He/she also should have an appreciation of the role that sheep play in providing food and fiber for modern man.

The authors have identified 107 study areas and skills that will help the club member understand the sheep industry. These topics have been divided as to their complexity into junior, intermediate and senior categories. Many of the skills listed in the junior and intermediate sections will be developed and improved over several years through the 4-H way of "Learning by Doing."

WRITTEN BY:

Ed E. Schrader - 4-H Youth Advisor, Kern County  
Ralph Phillips - PhD, Farm Advisor, Kern County  
Bruce Lane - Livestock Farm Advisor, Sonoma County  
John Emo - 4-H Specialist, Davis Campus

JUNIOR  
(9 thru 12 years of age)

The following 38 topics are recommended subjects a 4-H member should know.

(\* FIRST YEAR MEMBERS SHOULD DO \*)

- \* 1. Know the parts of sheep.
- \* 2. Know how to determine the sex of sheep (rams, ewes and wether).
- \* 3. Learn the normal body temperature of sheep.
- \* 4. Learn how to take temperature of sheep and the difference between a normal healthy sheep and sick sheep.
5. Know three types of feed and give two examples for each.
- \* 6. Learn building and space requirements of sheep held in confinement.
- \* 7. Know the correct way to restrain and handle sheep.
- \* 8. Know how to figure a budget for market lambs.
9. Learn three things wool is used for.
10. Know the USDA carcass grade of lambs.
11. Know the difference between wholesale and retail cuts of lamb.
12. Know the commercial value of a market lamb from start to finish.
- \*13. Find a commercial market quotation of fat lambs, feeder lambs, breeding ewe and cull ewe.
14. Know the health care equipment needed for a sheep project and the function of the equipment.
- \*15. Know why we fit sheep for show.
- \*16. Know how to handle sheep in show rings.
17. Develop a health program for lambs.
18. Know the function of shearing (when and why); both showing and commercial.
- \*19. Assemble a box containing the equipment you will need to show a lamb.
20. Know several ways lambs are grown for commercial slaughter.



21. Know the size and scope of the lamb industry in California.
- \*22. Know what rate of gain means.
23. Know what a good average daily rate of gain is for a market lambs.
24. Define three career opportunities in the sheep industry.
25. Know ten breeds of sheep, country of origin and functional purpose (wool, meat or milk).
26. Know the prevention treatment of footrot.
27. Know what colostrum is and its function.
28. Be able to identify the signs a ewe will exhibit in the latter stages of pregnancy and the signs that will indicate the ewe has started to give birth.
29. Know the correct position of the lamb for normal delivery.
30. Know the three "Ips" required for good management for the ewe and lamb at the time of lambing.
31. Know why, when and how to tag ewes.
- \*32. Know the reasons for docking sheep.
33. Outline a health program for ewe and lambs from breeding to weaning.
34. Know how and why we flush ewes.
- \*35. Know the type and reasons of footwear a person should wear when working around sheep.
- \*36. Know the correct safety procedures one should follow when handling or hauling sheep.
37. Know the proper fencing for protecting sheep from both wild and domestic predators.
38. Develop a plan to present to a bank or other lending institution for financing your lamb project. Show total amount of money you will need to invest, length of investment, income and cost insurance you will need to protect your investment.

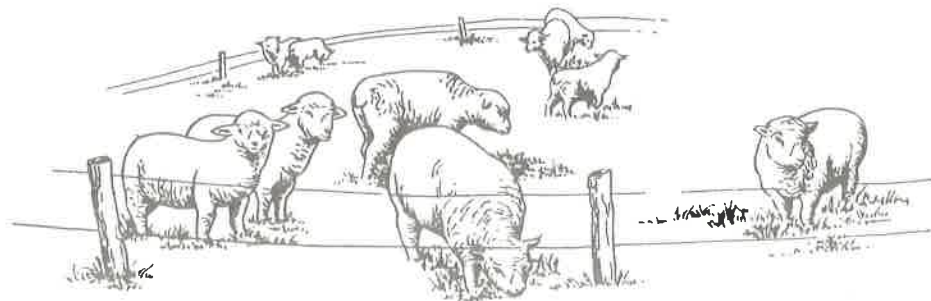

INTERMEDIATE  
(Members 13 thru 15 years old)

The following 36 topics are recommended subjects a 4-H member should know.

1. Know the difference between minerals, vitamins and the functions of each in the production of lambs.
2. Know the protein rich feeds and energy rich feeds. (Name five of each).
- ✓ 3. Know four internal and four external parasites that are common in sheep.
4. Know how to administer intermuscular and subcutaneous injections.
5. Know how to setup and maintain electrical shears.
6. Know how to trim sheep feet.
7. Identify three ways to keep sheep in confinement and cool during the summer.
8. Learn the importance of feeding sheep the same time each day.
- ✓ 9. Be able to diagram and label the parts of a sheep's digestive system.
10. Name five common diseases that affect sheep.
- ✓ 11. Know three grading systems of wool.
12. Know three things that affect the quality of wool.
13. Know the dressing percent of a lamb and explain how it is figured.
14. Identify the two most valuable wholesale cuts of lamb and what percent of the carcass they represent.
15. What is the single fact that determines the difference between a lamb and a mutton carcass?
16. Be able to describe the ideal lamb.
17. Be able to place a class of market lambs and give reasons.
18. Know the age and weight lambs are marketed.
- ✓ 19. Be able to tell the age of a sheep by looking at its teeth.
- ✓ 20. Know at least twenty breeds of sheep and the characteristics of five breeds.

21. Know three common methods of fitting a lamb for show.
22. Be able to explain how to show a lamb.
- ✓23. How does showing a lamb at a fair affect carcass quality?
24. Interview one person employed in the sheep industry. Know educational or experience requirements for that position.
- ✓25. Know the parts and function of the female reproductive tract.
- ✓26. Know the parts and function of the male reproductive tract.
- ✓27. Know what seasonal polyestrous is and some of the factors that affect it.
28. Know the common, scientific names, life cycles and control of the following parasites:

EXTERNAL

lice  
mites  
keds  
blowflies  
wool maggots  
nose bot

INTERNAL

roundworm  
hookworms  
lungworms  
tapeworms  
flukes  
coccidia

29. Know what is meant by slime and hide graft.
30. Know a safety procedure to follow when administering oral medication to sheep.
31. Know the equipment used for the safe administering of oral medication.
32. Know the equipment and/or method used to identify breeding activities.
33. Understand the following items as it relates to ram fertility.
  - a. Methods of checking ram fertility.
  - b. Diseases that affect fertility.
- ✓34. Know the management required for out-of-season breeding in sheep.
35. Explore the uses of guard dogs in your area.
36. Know how to raise an orphan lamb; feeding and management.

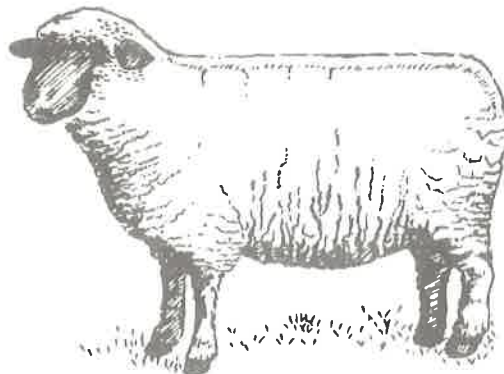

SENIORS  
(16 years old and over)

The following 34 topics are recommended subjects a 4-H member should know.

1. Be able to name the seven feed nutrition categories and explain their functions.
2. Know the pounds of feed needed to produce a pound of lamb.
3. On paper, buy 100 feeder lambs, feed to market weight and sell at market prices. Show all profit and losses.
4. Explain why sheep can live on just hay.
5. Prepare a calendar to show the life of a market lamb (from birth to slaughter).
6. Name two and explain two methods of castration and docking of lambs.
7. Know how to shear sheep.
8. Know the marketing system for wool.
9. Explain how feeding affects quality wool.
10. Explain the market system of the lamb industry in this area.
11. Visit a supermarket and list the retail cuts and price of the lamb you find.
12. Visit a Supermarket to determine the percent of their lamb that is imported and the percent that is domestic.
13. What is the per capita consumption of a lamb in the United States and how many times a month is lamb served in your home?
14. Find the number of sheep in the United States in 1970 and 1980.
15. From your county fair what happens to the market lambs. The percent purchased by slaughter companies, packing houses, number kept for breeding and the number that went to home freezers.
16. Describe methods of identifying flock ownership and individual sheep within the flock.
17. Visit a commercial packing house that slaughters lambs.
18. Visit a commercial sheep operation.
19. Develop a calendar of activities for a commercial sheep operation.
20. Contact a wool type sheep association and a meat type sheep association and ask for information on their breed.
21. Visit an Animal Science Department at a University or a research station to determine research going on with sheep.
22. Explore one career working with slaughter or marketing lambs and one career marketing wool.
23. What is mastitis and how do you treat it?

24. Know what crossbreeding is: list three of the advantages.
25. Describe the following inherited defects in sheep:
  - a. overshot jaw
  - b. undershot jaw
  - c. rectal prolapse
  - d. entropion (inverted eye lid)
  - e. cryptorchidism
26. What are the normal breeding habits of ewes:
  - a. puberty
  - b. anestrus - breed difference
  - c. time between estrus
  - d. length of estrus
  - e. when ovulation occurs
  - f. gestation
27. Know how the following factors affect reproduction in the ewe.
  - a. heredity
  - b. age of puberty
  - c. age of ewe
  - d. light, temperature, humidity and season
  - e. associates with ram
  - f. diseases and parasites
  - g. fertility of the ram
- ✓ 28. Name the different methods of pregnancy tests for ewes.
29. Outline a safety program to use when shearing sheep, from setting up shearing machine to actual shearing of sheep.
30. Know a safe way to manage rams.
31. Develop a forage plan for a flock of ewes - show cost of pasture - include all cost such as land, water, fencing, soil preparation and cost of dry lot operation.
32. What information is included in a pedigree and how can you use this information in selecting breeding stock?
33. Develop a record system using an index system for a flock of sheep.
34. Describe several fencing systems used by commercial sheep producers to protect their flock from domestic and wild predators.

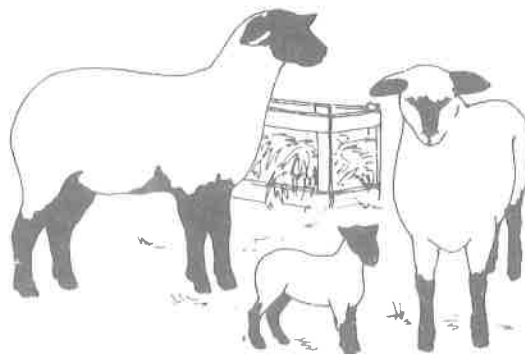

References and visual aids that are available at most county Extension Offices.

A list of 22 video cassettes that are available from the University of California Video Center.

SLIDES: Breeds of Sheep  
Care of Sheep

Nine of these slide sets  
are available from most  
local Extension Offices.

University of California publications are available at a small cost from the County Cooperative Extension Office.

Raising small numbers of sheep.  
Production Practices for California sheep.  
Ram Fertility.

4-H Publications:

California 4-H Sheep Project-Members Manual (4H-2043)  
4-H Sheep Project-Leaders Manual (4H-2044)  
Fitting Sheep (4H-2062)  
Showing Sheep (4H-2063)

REFERENCE BOOKS:

Diseases of Sheep, Rue Jensen, D.V.M., Ph.D., D.V.Sc., College of Veterinary Medicine and Agricultural Experiment Station, Colorado State University, Fort Collins Lea & Febiger, 1974, Philadelphia.

Raising Sheep the Modern Way, Paula Simmons, Garden Way Publishing, Charlotte, Vermont 05445

Recommendations for Profitable Sheep Production, G.E. Ricketts, F.C. Hinds, J.M. Lewis, Circular 1126, University of Illinois at Urbana-Champaign, College of Agriculture, Publishing Office, University of Illinois, College of Agriculture, 123 Mumford Hall, Urbana, Illinois 61801

Sheep Handbook, Housing and Equipment, MWPS-3, County Cooperative Extension Office

Modern Breed of Livestock, fourth edition, Hilton M. Briggs, Macmillan Publication Co., Inc. New York.

MAGAZINES:

Sheep Magazine, Countryside Dept., Waterloo, Wisconsin 53594

Hampshire World, Box HW, Cuba, Illinois 61427

California Sheepman's Quarterly, 3382 El Camino Avenue, No. 6, Sacramento, CA 95821

The Shepherd, R.D. 1, Box 67, Sheffield, Mass. 01257



# California

## 4-H SHEEP PROJECT

Animal science projects are favorites in California 4-H. The sheep project offers you fun while you learn about sheep and improve your knowledge and skills.

Your 4-H animal science leader can help you in 14 units.

1. Project Overview
2. Selection
3. Purchasing and Financing
4. Facilities and Equipment
5. Feeding
6. Health
7. Fitting and Showing
8. Marketing
9. Management
10. Extra Activities
11. Group Activities
12. Public Relations
13. Science
14. The California Sheep Industry

Discuss with your leader how many units you will cover each year. As you gain experience, you'll want to advance to other units in the project.

You can use the information in this guide for more than 1 year. **BE A CONSERVATIONIST. PLEASE SAVE THIS GUIDE.**

In the sheep project, you may want to: own an animal; manage but not own animals; or participate by working in related activities, such as sheep and the consumer, marketing, public relations, or science.

Before beginning any animal science project, both you and your parents need to find out what's expected. If you wish to have a live animal project, you must know what a desirable animal is, what facilities and feed you need for the animal, and the potential costs. The three types of live animal projects are as follows.

**Market animal.** You select, own, and feed one or more animals to market weight and then sell or use the meat at home.

**Breeding animal.** You own and raise one or more animals for breeding purposes. If you wish to show any animal, it must be registered in your name.

**Jointly owned or nonowned animal.** You can take part in this project no matter where you live—on a farm or in the city. You can jointly own an animal or manage, feed, and keep records on one or more animals—either on your own or with a group, such as on a 4-H farm. You can't show jointly owned or nonowned animals at fairs.

## OVERVIEW

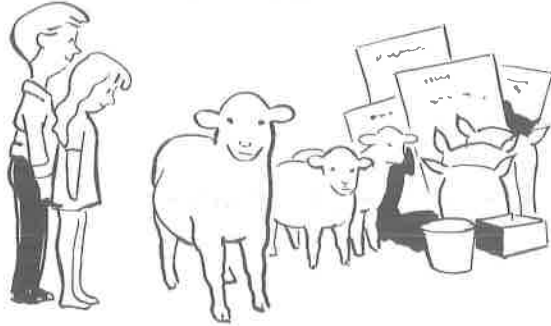

The sheep project is a part of a **total animal science program**. You don't need to live on a farm to participate in a 4-H sheep project. There are lots of things you can learn and do without owning an animal.

If you wish to take the market animal or breeding project, you and your parents will want to visit a successful 4-H sheep project to learn about the costs, facilities, and time needed for the project.

Each of the units in this guide provides you with information about the project. Your leader will assist you. His interest in and knowledge of sheep, combined with teaching aids from the county Cooperative Extension 4-H office, will help you have a pleasant experience—and FUN, too.

## SELECTION

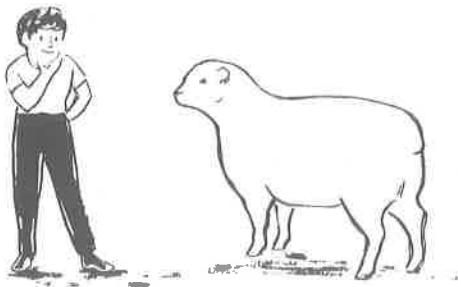

Raising sheep is an interesting and challenging project. You can successfully raise sheep in a variety of locations—range, pasture, dry lot, or in a small pen in your backyard. Sheep do not need expensive shelters or equipment. They produce two products—meat and wool. You can raise a lamb to market weight in 4 to 6 months on a relatively small amount of feed. Sheep are also a good way to produce meat for home use.

First decide whether you want to raise sheep for marketing or breeding. The facilities you have available may influence your choice.

**Market animal.** If you wish to raise a lamb for meat, select a grade blackface or crossbred, commercial-type feeder lamb that weighs 50 to 70 pounds.

**Breeding animal.** If you wish to raise a small flock of sheep, consider selecting grade whiteface ewes for breeding to a blackface ram. If you wish to exhibit sheep at fairs, choose registered ewes and rams of a breed you like. Select a breed common in your area so you can easily obtain replacement animals.

Regardless of the type of project you have, select large-type animals that are healthy and free from defects. Select an alert, active, healthy animal. Don't choose a lamb that limps, has diarrhea, or a runny nose. Look at each foot to see if the animal has foot rot. Ask your parents, 4-H leader, or a commercial or purebred sheep breeder in your area for help in selecting your animal.

## PURCHASING AND FINANCING



Be sure to figure on enough money to: buy your animal; buy feed for the entire length of time you'll have the animal; purchase or make basic facilities and equipment; and pay for any veterinary supplies or services needed.

Sources of financing are: money you have earned; money borrowed from your parents; or money borrowed from banks or other lending institutions.

If you plan to borrow money from a lending institution, arrange the loan before you buy an animal. Be businesslike. Know the amount of money you need and how long you'll need it. Estimate your costs and potential income. List any assets (things of value) you have. Call the lender for an appointment. Arrive on time and neatly dressed. Know your facts and figures. Ask questions if you don't understand any of the terms used in the discussion.

Ask your leader about places where you may be able to buy an animal.

## FACILITIES AND EQUIPMENT

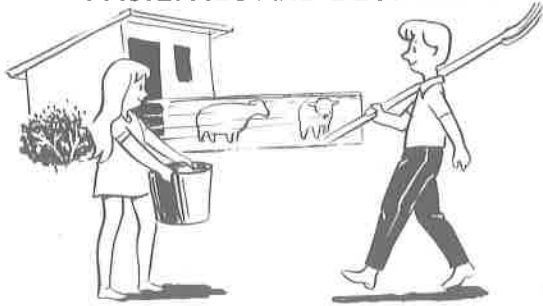

Lambs need less space and equipment than many animals do. While you can raise sheep on pasture, a 10- by 10-foot pen is adequate for one lamb. Provide more space for each additional animal.

**Shelter.** You need something to protect your lamb from wind, rain, and sun. A simple shade is adequate in some areas. A small shelter, about 4 by 6 feet, that contains a manger is ideal. It can be open on two sides, but must provide protection from winds and storms.

**Feeding.** You can use a small box attached to the side of the pen as a manger for feeding lambs. Allow 1 foot of manger space per animal. Be sure the box or manger is high enough off the ground so the lambs can't step in it. If you plan to feed hay (necessary for breeding animals), provide 1 foot of hay rack space per lamb. You also need a salt box and a water bucket.

**Fitting and showing.** If you want to exhibit your lamb, you'll need to own or be able to borrow a wool card, brush, and hand shears. If you plan to have a sheep project for several years, a blocking stand may be desirable.

If you plan to raise a farm or purebred flock, discuss the facilities you need with your parents and leader.

## FEEDING



How fast a lamb grows depends on three factors: **inheritance**, **feed**, and **care**. A lamb's growth rate is inherited from its parents. How fast the lamb actually grows depends on the feed and care you give it.

There are two methods you can use to feed lambs—hand feeding and self-feeding. Hand feeding means that you give the lamb a specific amount of grain and hay twice a day. Self-feeding means that you put a complete mixed ration or feed pellets in a feeder and let the lamb eat all it wants. Ewes and lambs also do well on high-quality green pasture.

The easiest way to raise a market lamb is to self-feed a pellet composed of 20% to 30% grain and 70% to 80% alfalfa hay. Never allow the lamb to run out of pellets. A lamb will consume 3 to 5 pounds of feed per day and will usually gain 1/3 to 1/2 pound a day.

If you hand feed, gradually increase the amount until you're feeding the animal about 2 pounds of grain and 2 to 3 pounds of alfalfa hay per day. If grain becomes too expensive, cut down the amount of grain you feed. It takes 7 to 10 pounds of feed to produce 1 pound of gain.

Be sure that salt and clean water are available at all times.

## HEALTH



Provide your animal with a clean pen and equipment, fresh water, salt, and a correctly fed, balanced ration. Also control external and internal parasites and protect against disease. Always be alert! Watch how your animal breathes, walks, holds its ears; observe its stools.

If the animal appears sick, work with your parents or leader to check its temperature (normal rectal temperature is 103° F. plus or minus 1°). If your animal is sick, check with your veterinarian, leader, or parents for recommended treatment. When using chemical controls, **be sure to carefully read and follow the application instructions on the container label.**

Newborn lambs require specific shots and other care. Feeder lambs may need worming and vaccinations for pulpy kidney (enterotoxemia) and white muscle diseases. Work out a management and vaccination program with your leader or veterinarian.

## FITTING AND SHOWING

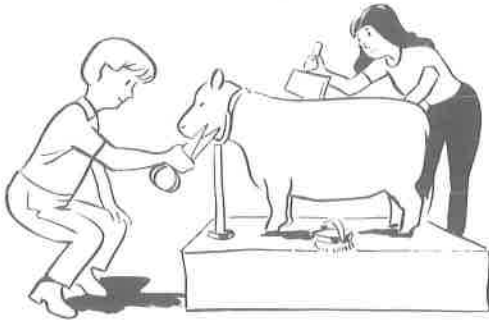

Make friends with your animal. Gentle it down by working with it each day.

If you plan to exhibit a market lamb, shear it 45 to 60 days before the fair. If the lamb's fleece is dirty, wash the animal 2 to 3 weeks ahead of time. After washing, put a sack blanket on the lamb and keep the floor of the pen covered with clean straw or shavings.

Before show day, trim and clean the lamb's hoofs. Wash its ears with a rag. Use a wool card to remove loose fibers and dirt from the fleece. Use hand shears to trim the fleece so the animal appears neat. It's advisable to brush the wool with a sheep dip solution while trimming to make the fibers stiff and give a smooth appearance to the fleece.

When showing your lamb, remember to keep your lamb between you and the judge. Always have a firm grip on the lamb. Place one hand under the lamb's jaw and throat and the other hand over the lamb's dock area and move it slowly around the ring.

Check with your leader for more details about preparing and showing breeding stock.

## MARKETING

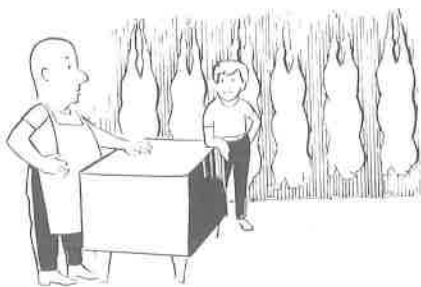

As a sheep project member and as a consumer, you'll want to learn about carcass evaluation,

dressing percentage, cutability, and the prices of wholesale and retail cuts of meat.

The ideal lamb carcass has a high yield of high-quality muscle (lean meat) and a minimum of waste. Carcass evaluation is determined by: **conformation**—even balance between front and rear quarters; **finish (fatness)**—external, internal fat in the body cavities and that between the muscles (extramuscular) or within the muscles (intramuscular); and **quality**—marbling, color, texture, and firmness of lean.

The lamb must grade Choice or better to sell at most junior livestock auctions or on the commercial market. Marketing success depends on the grade of the animal at purchase, your feeding program, dressing percentage, carcass grade, availability of buyers, and demand for lamb.

Wool is the other salable commodity from sheep. Keep the sheared wool clean and correctly tied with paper twine. Check with your leader to find out about wool buyers in your area.

## MANAGEMENT

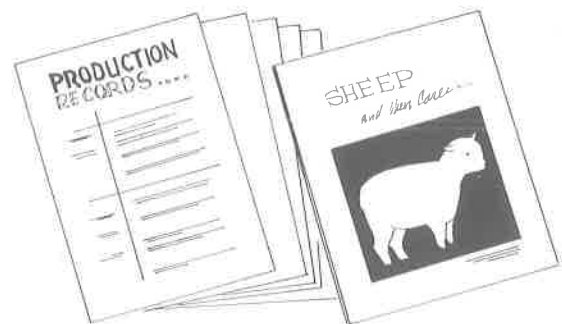

Management includes planning your project, selecting your animal, providing correct facilities and equipment, feeding, maintaining animal health, learning to keep records, and, if applicable, breeding. You'll learn that some management tasks are done at designated times of the year.

Work with your leader to set up a month-by-month sheep or lamb management calendar. This calendar will help you keep more accurate records and improve your knowledge of the sheep industry.

## EXTRA ACTIVITIES

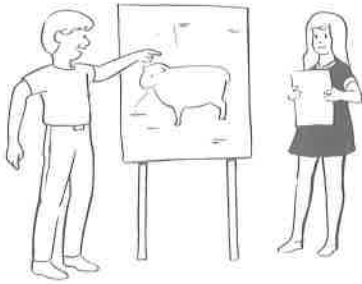

You'll want to take part in the sheep project's extra activities. These include demonstrations, livestock conservation, and livestock judging.

A **demonstration** is a planned presentation that teaches something by illustration or example. It may include: an introduction (why the topic was chosen and why it is important); the body (how the job is done); and a summary (what was accomplished, its meaning to the demonstrator and the audience). Plan and give at least one demonstration each year—either by yourself or with other members. Your junior leader or project leader can help you with ideas for titles, subject matter, and presentation techniques.

**Livestock conservation** includes learning about animal protection and safety. Give conservation demonstrations; plan and participate in safety tours and checks; do a research paper on a topic of special interest; or design your own conservation activity.

**Livestock judging** is the process of analyzing animals and measuring them against a standard commonly accepted as the ideal animal. Learn the parts of the sheep shown in figure 1.

Learn to compare animals by developing an evaluation system. View each animal from the side, rear, front, top, and while walking; use the same order each time you view an animal. Take notes on why you like each animal and use these notes to practice giving oral reasons.

When giving oral reasons, stand 6 to 8 feet away from the judge, look him in the eye, and speak in a conversational tone without using notes. Keep oral reasons to about 2 minutes in length. Use and emphasize comparative terms (more-muscled, longer in the rump, thicker, etc.).

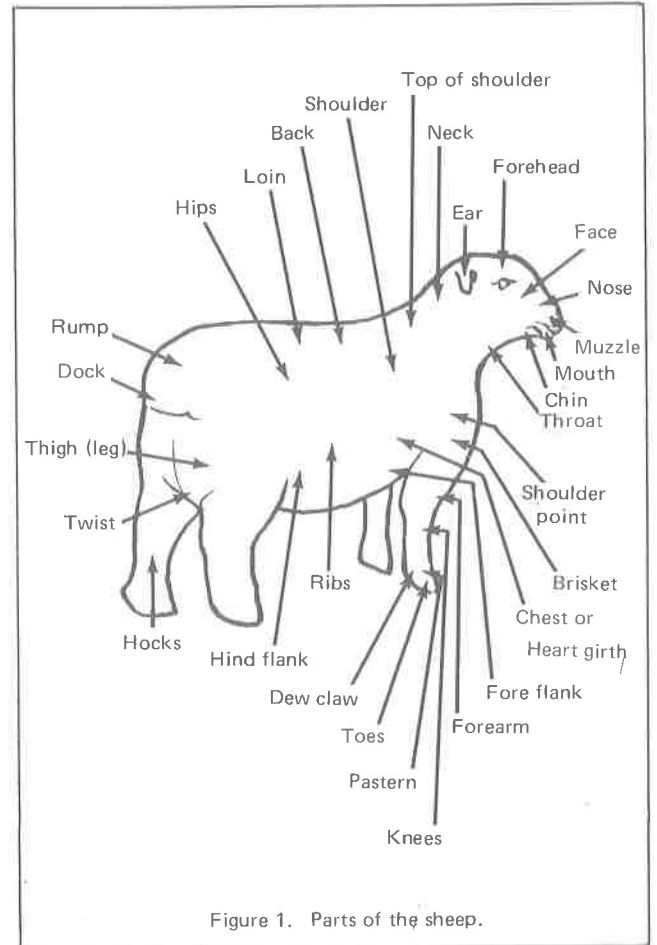

Figure 1. Parts of the sheep.

## GROUP ACTIVITIES



Working together to "Make the Best Better" can easily describe group activities. These activities are suitable for all phases of the sheep project and help you gain a broader knowledge of agriculture.

Discuss and plan with other members what you want to do or learn; study the activity; list and secure resources to enhance the study or event; find possible solutions to the problem (or event); complete the activity; and evaluate it. In a total animal science program, group activities have no boundaries. (For example, those enrolled in foods and nutrition can explore the uses of sheep, barbecuing, or whatever else is of interest.)

## PUBLIC RELATIONS



Public relations is an everyday job with many opportunities to work, learn, and serve. Three needs are to: 1) foster good relations with livestock producers, industries, and organizations; 2) improve public knowledge and appreciation of the animal sciences; and 3) help others understand the need for raising animals for food, fiber, and recreation—balanced with a concern for the environment.

You can become a junior member in a breed association; prepare exhibits on livestock for showing at schools, fairs, or shopping centers; or host a non-4-H member on a visit to a fair, farm, or your home to promote better understanding of the livestock industry. You can work with many different people, including urban youth, civic leaders, health and safety groups, businessmen, and others. Improving public relations starts with you.

## SCIENCE



In this science unit, you need to learn about nutrition and genetics. **Animal nutrition** is the study of the feeding process and how the animal uses feed. Sheep are ruminants, as are cattle, deer, and goats. The ruminant animal has a complex

stomach that's divided into four parts—rumen, reticulum, omasum, and abomasum. This type of stomach allows an animal to digest high-fiber diets, such as range, pasture, and hay.

**Genetics** is the study of how animal characteristics are passed from parents to offspring. As you progress in the sheep project, you'll learn more about genetics and its use in improving your herd.

To learn more about science in your sheep project: identify feeds and know how they are used by the animal; and learn how feeding, breeding, and management of sheep relate to the basic sciences of nutrition, genetics, physiology, and animal medicine.

## THE CALIFORNIA SHEEP INDUSTRY

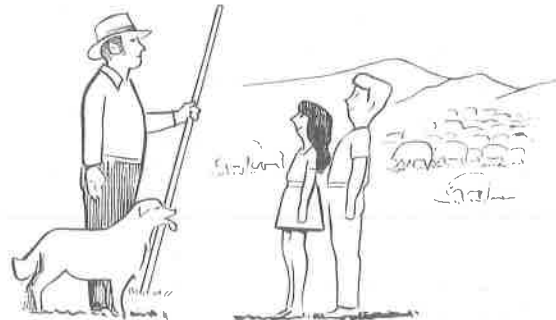

Californians like eating lamb. They consume about 5½ pounds per person every year; that's about 3 pounds more than the average per person consumption in the rest of the United States. California ranks third in the nation in the number of stock sheep raised; Texas is first and Wyoming is second.

As a sheep project member, you'll want to learn more about the sheep industry. Visit your county sheepmen's meetings to hear their concerns, give promotional talks on the sheep industry, or study sheep markets and prices.

## GLOSSARY OF SHEEP TERMS

<b>Breed</b>	—	Animals of like color, type, and other characteristics similar to those of parents or past generations. Some breeds of sheep are Hampshire, Shropshire, Suffolk, Columbia, Rambouillet, Corriedale.	<b>Parturition</b>	—	Act of birth.
<b>Castrate</b>	=	To remove the testes of male sheep.	<b>Pedigree</b>	—	A table that gives a line of ancestors for an animal; a genealogical tree.
<b>Dam</b>	=	A female parent.	<b>Purebred animal</b>	—	An animal of a recognized breed kept pure for many generations. A purebred animal may or may not be registered, but all registered animals are purebred.
<b>Ewe</b>	—	Female sheep.	<b>Ram</b>	—	Male sheep of any age that is uncastrated.
<b>Feeder</b>	—	A weaned animal that is ready for feeding or that is being fed for market.	<b>Ration</b>	—	The total feed given any animal during a 24-hour period.
<b>Finish</b>	=	Degree of fatness and readiness for market.	<b>Registered animal</b>	=	Purebred animal that has a registration certificate and number issued by the breed association. The animal's name is recorded together with the names of the sire (father) and the dam (mother).
<b>Fitting</b>	=	The process of fattening, training, and grooming an animal for show or sale.	<b>Wether</b>	—	Male animal that has been castrated before sexual maturity.
<b>Grade animal</b>	—	An animal that has one or both parents not registered with a breed association.			
<b>Lamb</b>	—	Young sheep of either sex under 1 year of age.			

Prepared by Raymond G. Lyon, 4-H Youth Advisor, Glenn County, in conjunction with the Animal Science Materials Committee.

The University of California's Cooperative Extension programs are available to all, without regard to race, color, or national origin.

Cooperative Extension work in Agriculture and Home Economics. United States Department of Agriculture and University of California cooperating.



# **KERN COUNTY 4-H SHEEP PROJECT GUIDE**

Lesson Plans

## **4-H SHEEP PROJECT OUTLINE**

### **MARKET LAMB**

Meeting Information to Cover

1. Project Overview
2. Facilities and Equipment
3. Purchasing and Financing
4. Selection
5. Feeding
6. Health
7. Fitting and Showing
8. Record Book "Requirement"
9. Breeding Sheep/Market Lambs

### **NOTE: A GOOD SOURCE OF INFORMATION FOR SHEEP**

1. Kern County Farm Advisor Office, Bakersfield – *"Sheep Magazine"*
2. Local Book Stores – *"Raising Sheep The Modern Way"*

## **PROJECT MEETING**

### Number 1: PROJECT OVERVIEW

1. Roll Call
2. Review all members' past experience
3. Introduce and welcome new members
4. Discuss possible project cost
5. Discuss meat-breed sheep vs. wool breed sheep, give examples
6. Discuss possible meeting times/places
7. Get junior leaders involved
8. Open for questions
9. Discuss record books; they are a requirement

## **PROJECT MEETING**

### Number 2: FACILITIES AND EQUIPMENT

#### **MARKET LAMB**

- Should have a pen space at least 10' x 10'
- Should have a cover from rain, weather, and sun
- Equipment needed:
  - Shears/Clipper
  - Blocking Table
  - Halter
  - Water Bucket
  - Feeder for Hay and Grain

**NOTE: DO NOT EVER FEED HAY ON THE GROUND**

#### **PURCHASING AND FINANCING**

##### Estimated Cost

- Facilities
- Equipment
- Feed
- Health Supplies
- Show Entry Costs
- Lamb or Breeding Sheep

## PROJECT MEETING

### Number 3: Selecting a Project Market Lamb

- You can raise your project market lamb to market weight in about four to five months
- A good average weight for a feeder lamb should be about 55 to 75 pounds when purchased in May
- Things to consider when buying your project market feeder lambs:

#### OVERALL APPEARANCE

Good straight back  
All four legs are good  
Eyes are clear  
Nose clean  
Long wide loin  
Good muscling  
Clean brisket area  
Straight neck  
Good head  
Good overall conformation  
Good price

**NOTE: CONFORMATION IS MORE IMPORTANT THAN BREED CHARACTER**

## **PROJECT MEETING**

### Number 4: Feeding

- Types of Feed

Roughages

Concentrates

**NOTE: BOTH TYPES OF FEED CAN CONTAIN FIVE NUTRIENTS; ENERGY, PROTEIN, VITAMINS, MINERALS, AND WATER.**

### Balancing a Ration

- To mix a ration properly, you must know feeds and the nutrients they supply
- All packaged lamb feeds have a tag attached to describe its mixture
- Salt

**NOTE: OUR FEED COMPNAIES TODAY PROVIDE US WITH GREAT FEED PACKAGES, TO BUILD AND MAINTAIN OUR PROJECTS**

### Health

- Worm your project
- Fresh water
- Clean facilities
- Fly protection
- Sickness

## **PROJECT MEETING**

### Number 5: Fitting, Showing, Management, Record Book

#### Fitting and Showing

- Equipment used for fitting
- Trim feet
- Showmanship
- Proper process for presenting in show ring
- Practice, Practice, Practice

#### Management

- Record keeping of all expenses for project

**NOTE: THIS IS A BIG PART OF YOUR RECORD BOOK ALONG WITH OUR EXPERIENCES WE RECORD**

#### Record Book

- Review of purpose for 4-H record books

**NOTE: THE RECORD BOOK IS A REQUIREMENT EACH YEAR IN 4-H AND COUNTY FAIR**

To ensure the weight of your market lamb is on track for our county fair, you need a place to weigh. A good average daily gain is one half pound a day with a good feed program. Always check the fair entry catalog for entry weight and top weight each year.

## **PROJECT MEETING**

### Number 6: Breeding Sheep

#### Breeding Sheep

- Discuss costs
- Discuss breeds
- Discuss responsibilities
  - A. Care
  - B. Shearing
  - C. Feeding
  - D. Facilities
  - E. Breeding time
  - F. Lambing time
  - G. Facilities
  - H. Marketing
  - I. Management in general
  - J. Time involved
  - K. Health
  - L. Record Books

**NOTE: CHECK THE “NOTES FROM THE SHEEP BARN” FOR ADDITIONAL INFORMATION YOU MAY WANT TO USE IN PROJECT MEETINGS**



# Put *Your Best Sheep* Forward



UNIVERSITY OF CALIFORNIA

AGRICULTURAL EXTENSION SERVICE

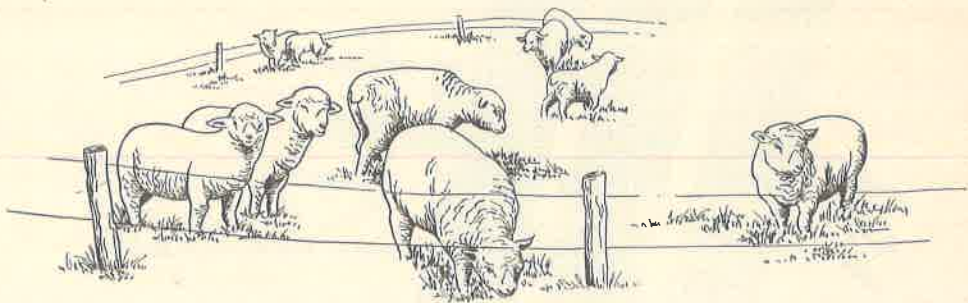

# PUT YOUR BEST SHEEP FORWARD

By

*Donald G. Addis*

## In General

If you were on exhibit, you would want to look your best. Naturally, you will want your show sheep to make a good appearance. Plan to have them well-mannered, carefully groomed, and properly shown. Such sheep will bring honors to themselves and to you.

You should start early to groom your sheep and to give special attention to their feeding and care—fitting is the term commonly used for this. Start this fitting about two months to ten weeks ahead of showing. The more sheep you plan to show, the earlier you should begin.

If you are planning to exhibit breeding sheep, keep in mind that they show best if they have a long fleece. If you have fat lambs, you probably will wish to shear their backs about two months before the show. This not only makes blocking—trimming to give a blocky appearance—easier but also helps keep the lambs cooler. Frequent trimmings will help give the animals the appearance you wish them to have.

Before planning to enter your sheep at any single fair or show, check to make certain there is a class in which your sheep will fit.

Certainly, as exhibit day looms ahead you will want to “put your best sheep forward.”

*The author is farm advisor, Riverside County*

## Select Sheep Wisely

In selecting your sheep for show, consider the ideal breed type and then how nearly your animal comes up to that standard.

The breed associations for each of the main sheep breeds set up standards for that breed. Each association also prepares information which includes photographs or drawings showing top animals of that breed. You or your leader can secure these without charge by writing the association for your breed of sheep.

In general, the mutton breeds . . . those raised chiefly for meat production . . . should be low-set, compact, thick, and heavily muscled. They should have a wide level back, a deep full rib, thick thigh, a smooth shoulder, and a general fullness of outline. The neck is short, full and smooth at the shoulders, neat at the throat, and somewhat arched. The head is broad, short, and neatly carried. Straight legs with ample bone, placed squarely under the body, and strong appearing pasterns are typical of good animals.

Some animals are undesirable for showing because of being thin, having crooked legs, dark fibers, blue skin, skurs, weak pasterns, and weak shoulders.

## Gather and Use Tools

In preparing your sheep for showing, you'll need the help of a few tools. Either a medium-fine fiber

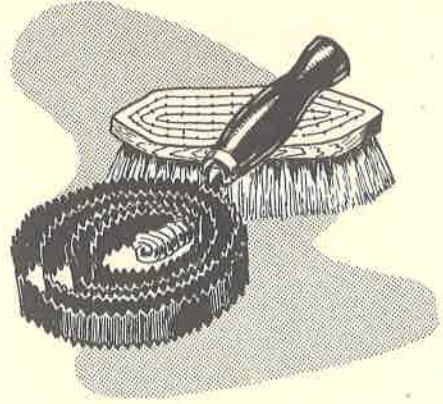

Brush and comb

brush or a round spring curry comb will help you clean up the sheep's fleece. The brush also can be used to dampen the wool with a water dip solution. This solution is made by adding two tablespoons of coal tar dip to one gallon of water. Use the solution sparingly.

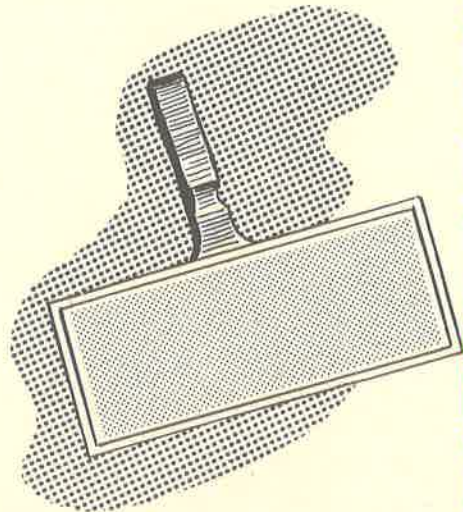

Wool card

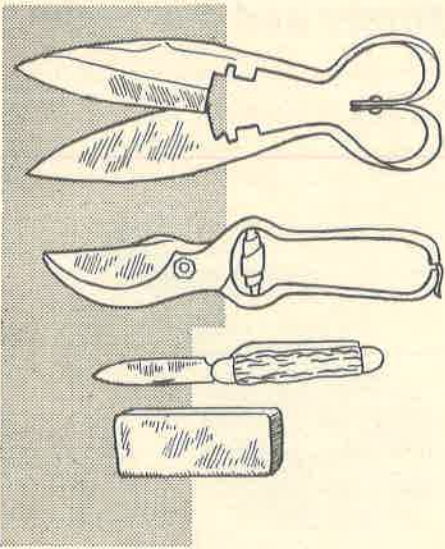

Sheep shears, pruning shears, knife, and whetstone

full of wool, it may be cleaned with a brush, or with an old table fork which has had a 1-inch right angle bent in the prongs.

Use good sharp shears on the wool. Only with sharp shears can you obtain a smooth, even appearance. You develop ability to use the shears through practice.

Knives or pruning shears are used to trim the horny part of the hoof. If the feet are soft, a pocket knife may serve; if they are hard and dry, pruning shears are a good tool.

### **You'll also need:**

- A double loop halter made from quarter or three-eighths inch three-ply rope ten feet long.
- An oil stone for sharpening your shears.
- An eight-quart bucket for dip.
- A burlap bag to make a sheep blanket.

## **Shine 'em Up**

The purpose of blocking is to present your 4-H project sheep in the most attractive way possible. Blocking is a skill that you will acquire with patience and practice. At first, work on your poorer sheep.

In starting the blocking and training process keep in mind breed type. Know the characteristics which distinguish your breed from all others. To do a good job you must have in mind the breed association model of perfection. So carefully examine your sheep first. Is it pinched in the

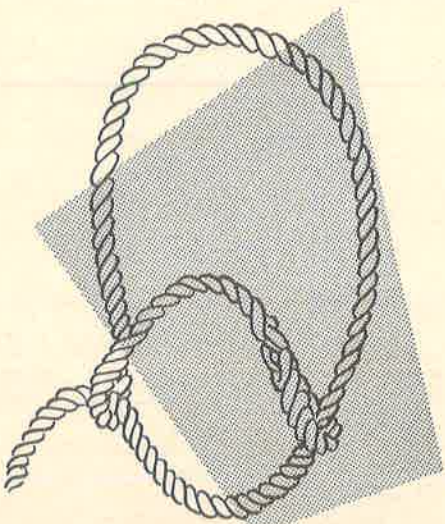

A double loop halter

heart girth, high in the shoulders, low in the back, or cut up in the twist? Keep these or other faults in mind as you make your animal conform to the ideal pattern as nearly as possible.

### **Let's Begin Underneath**

First, trim the feet so that your sheep stand evenly and well up on their toes. If not trimmed, the feet become filled with dirt, rocks, and filth. This might make your animals lame, and it gives them a broken-down appearance in the pasterns. By setting the sheep on its rump, and bracing its back with your legs, you can reach all four feet. The outside horn is trimmed so that it is nearly level with the sole. Avoid cutting too deeply. Examine your sheep's feet often.

### **Next, Use Brush**

Place the sheep on level ground and make sure that it is standing squarely on all feet. With the aid of your halter, tie the head so that it will be held in the natural position. Dip your brush into the mild dip solution, shake out well, and vigorously brush all foreign matter from the wool. It may be necessary to wash dung-covered locks with soap. Dampen the wool on the back and with the use of the card, pull up the wool fibers. Carding will partially remove dirt.

### **For That Well-Groomed Look**

Kneeling at the rear of your animal, begin "cutting down" the back

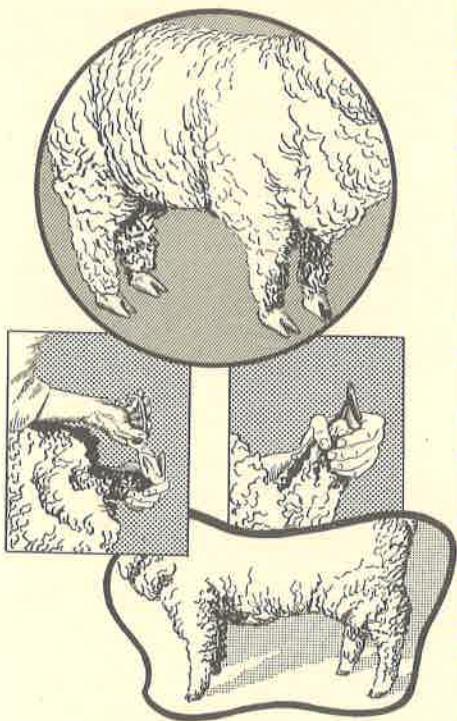

Trimming the feet enables your sheep to stand evenly

wool, from a point on the top of the hips, to the shoulders. Be careful not to cut too deep in any one place. Repeat the carding and trimming until the back becomes level and broad. Your shears should be held flat against the body. Practice hold-



Trimming the back wool, a step in blocking



Hold shears flat against the body in trimming sides



Carding the wool



Holding the card in proper position to work on the back wool



Card being removed from the wool

ing the bottom blade still, making the top blade do the cutting. Leave at least  $\frac{3}{4}$ " wool on the back of breeding sheep. On fat lambs, trim the wool closer. Short wool makes the back feel firmer.

### FIRST, RIGHT

Trim the right side of the sheep in the same manner. Most of the cutting will be done along the middle. The object is to make your animal appear wide from front to rear. Depth of body and low setness are important. Trim only enough wool from the belly to even the underside.

### THEN, LEFT

Now you are ready to trim the left side. Move to the front and left of your animal. Dampen the fleece, card up and trim off the fuzz ends. The rump is trimmed so that it is straight and level. The dock is squared to show width and plumpness, and the leg of mutton trimmed to give a full appearance.

### GO TO THE HEAD

Keep in mind the ideal breed appearance. Trim the head to conform to the breed association's standards. The head and neck should blend smoothly into the shoulders.

### PACKING

After you have blocked the sheep, you can improve the appearance and feel of the fleece by lightly patting it with the back of the card. This has the effect of packing the fleece. While trimming, remember to keep

your wool damp, but not soaking. Carding improves the texture . . . it cannot be done too often. After trimming fit your sheep with a blanket, but make sure it does not cut into the wool. Keep your sheep dry. Heavy rains will wash the yolk, or oil, out of the wool. This will destroy the lustre and bright healthy appearance of the fleece.

### ***Handle with Care***

Confine your show sheep to a small shed or lot to make catching and handling easier. Keeping them in a lot also lessens the danger of over-exertion by the sheep.

Sheep should not be caught by their wool. Rough handling by the wool causes bruise spots to appear on the carcass. The most desirable place to catch a sheep is by the neck or flank. Young animals are easily caught by the rear flank with the full hand. Without pinching, pull upward as if you intended to lift the rear end off the ground. Larger, more unruly animals may be caught by placing one hand under the jaw and the other on top of the head or neck.

When moving your animal, place the left hand under the jaw, grasping some wool if necessary. The right hand is placed on the dock. By gently pinching or applying pressure to the dock and guiding your animal with the left hand, your sheep can be moved easily. Learn to move your animal with the least apparent effort. Work with your sheep



The rear of the sheep after trimming



A blanket made from a burlap sack



Hold sheep correctly for moving it



Good sports, win or lose

enough so that it can be easily posed, and will not become excited when handled by the judge.

Daily exercise is important for your sheep. Neglect may result in sickness or loss. However, rest also is as important to your sheep as it is to you. After a long journey, it is better to leave the animal undisturbed than to force it to eat.

## ***Comes the Big Day***

The show day is an exciting day for the exhibitor! In addition to the feeding, watering, and cleaning of pens, there is much to be done. There are final touches to be given to the sheep. As for yourself, don a white uniform, 4-H cap, and green tie.

If the judging starts at 9:00 a.m.,

be ready then. If you are late, the class in which you entered will be judged and your sheep will not be shown. *Be ready early, and stay by your animal.* As a livestock exhibitor, people will ask you many questions. Be prepared to answer them courteously and promptly.

The most important object in the show ring is your sheep. Be alert and calm. Set your animal up and show it every minute. Give the judge every opportunity to see and examine your sheep. Be conscious of the judge at all times. Never allow him to come between you and your animal. When he asks you to move your animal up or down the line, do so promptly. Be considerate. Move into the new position from behind the line and continue to show your animal. Avoid having your animal



come in contact with those of your competitors.

When the decision is finally made, be sensible. If your sheep have won, accept congratulations modestly. Allow the animals to wear the ribbon. If you lose, lose graciously. Never lose your temper. Don't grumble at your animal, the judge, or other showmen. Congratulate the winners. Retire from the ring after the placings are made and entered in the judging book. If the show does not afford you the opportunity of learning more about showing and judging, you have missed the basic reason for your taking part.



A well-mannered prize winning animal, carefully groomed and properly shown

## ***Responsibilities at the Show***

At the show the following responsibilities are yours, and you as an exhibitor must accept them:

- Keep your alleys clean and free from feed, show boxes, etc. If the alleyways around your pens are dirt, rake them often and dampen them to minimize the dust.
- Your pens should be clean and bedded with ample straw. Your animal's comfort is your first consideration.
- Both you and your animal should be clean and well-groomed.
- As an exhibitor, you need to present a neat, attractive appearance and be a credit to the 4-H clubs of your community.
- Be courteous to all. Never make yourself conspicuous by rough-housing.
- If you have no entries in a particular class and your fellow members do, assist them with their showing.
- Help younger members who are exhibiting for the first time.

If your free time is spent discussing feeding and management practices with the shepherds and judges you will increase your knowledge. If your time is spent at the midway you will increase your expenses.

Co-operative Extension work in Agriculture and Home Economics, College of Agriculture,  
University of California and United States Department of Agriculture co-operating.  
Distributed in furtherance of the Acts of Congress May 8 and June 30, 1914.  
J. Earl Coke, Director, California Agricultural Extension Service.



*Animal Care Series:*

440 OFFICE COPY

S

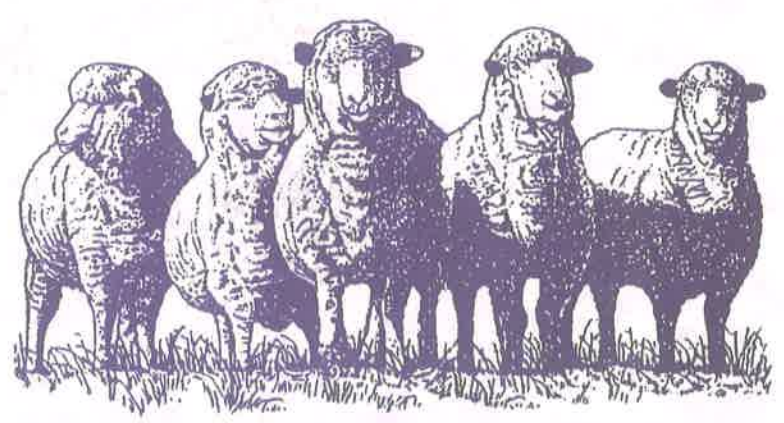

SHEEP

CARE PRACTICES

Sheep Workgroup  
University of California ♦ Cooperative Extension

8-70124

## FOREWORD

*Sheep Care Practices* is one of a series of University of California publications addressing the issue of animal care relating to food animal production in California. This publication is the result of a joint effort between the University of California Cooperative Extension, sheep industry representatives, and members of the sheep workgroup.

The authors include: John Glenn, D.V.M., Ph.D., extension veterinarian, School of Veterinary Medicine; Stephanie Larson, livestock advisor, Sonoma and Marin Counties; Gary Markegard, livestock advisor, Humboldt-Del Norte Counties; Aaron Nelson, livestock advisor, Fresno County; Ralph Phillips, livestock advisor, Kern County; Ed Price, Ph.D., professor Animal Science Department; Carolyn Stull, Ph.D., animal welfare specialist, School of Veterinary Medicine.

It was edited by Gary Beall, extension communications specialist; Stephanie Larson, livestock advisor in Sonoma and Marin counties; Aaron Nelson, livestock advisor in Fresno County; and Ralph Phillips, livestock advisor in Kern County.

Industry reviewers include Paul Ansolabehere, D.V.M., Bakersfield, Patricia Bernal, sheep producer; Kathy Lewis, sheep producer and chair, California Woolgrowers Animal Welfare Committee; Jay Wilson, executive director, California Woolgrowers.

Contributors include Monte Bell, livestock advisor, Glenn County; Mike Freeze, sheep producer; John Harper, livestock advisor, Mendocino County; Jim Oltjen, Ph.D., animal management systems specialist, Animal Science Department; David Pratt, livestock advisor, Solano County; Tom Schene, sheep producer; Marion Stanley, livestock advisor, Monterey County.

### **Acknowledgement**

We would like to acknowledge Ken Ellis, Extension animal scientist, emeritus, and Eric Bradford, Ph.D., animal science professor, emeritus, for their leadership in addressing food animal welfare issues. We would also like to acknowledge the contributions of Laura Sauter, secretary, Sonoma County Cooperative Extension, and Arlene Chin, Extension Visual Media, for their important contributions to the success of this publication.

This information in this publication is valid as reference material until June 30, 1996, unless revisions are necessary at an earlier date.

The University of California, in compliance with Titles VI and VII on the Civil Rights Act of 1964, Title IX of the Education Amendments of 1972, Sections 503 and 504 of the Rehabilitation Act of 1973, and the Age Discrimination Act of 1975, does not discriminate on the basis of race, religion, color, national origin, sex, mental or physical handicap, or age in any of its programs or activities, or with respect to any of its employment policies, practices, or procedures. Nor does the University of California discriminate on the basis of ancestry, sexual orientation, marital status, citizenship, medical condition (as defined in section 12926 of the California Government Code) or because individuals are special disable veterans (as defined by the Vietnam Era Veterans Readjustment Act of 1974 and Section 12940 of the California Government Code). Inquiries regarding this policy may be addressed to the Affirmative Action Director, University of California, Agriculture and Natural Resources, 300 Lakeside Drive, 6th Floor, Oakland, CA 94612-3560. Telephone (510)987-0097.

## INTRODUCTION

The well-being of sheep is an important component of a sheep ranching operation. Proper management yields benefits to both the sheep and the sheep producer.

The California sheep industry is diverse. Sheep production extends from the southern deserts to the northern coastal ranges. Management practices that incorporate good animal care under these diverse conditions can only enhance sheep production. Sheep breeds are chosen to best meet these conditions, and their genetic diversity enables the sheep to be adaptable. Sheep can utilize rangelands that other domestic animals cannot. This utilization helps maintain the rangelands and reduce the potential for fire hazards.

The number of family-owned farm flocks is on the increase. These farm flocks allow families the opportunity to experience the rewards of raising sheep while providing additional income to the family. Farm flocks and rangeland operations comprise the majority of the sheep industry in California and the rest of the United States.

Science has not yet provided all the answers we need to fully understand animal needs, but the practices presented are based on published data, scientific principles, expert opinion, and experience with the methods and practices for the safe, humane, and efficient production of sheep in California.

This publication explains why and how sheep care practices are used in the diverse sheep operations of California. It is intended to help producers evaluate their husbandry practices with respect to the well-being of their animals and to outline ethical care practices that maintain production efficiency.



## TABLE OF CONTENTS

Stress . . . . .	2
Behavior . . . . .	3
Environment . . . . .	4
Transportation . . . . .	8
Health . . . . .	9
Nutrition . . . . .	10
Identification . . . . .	12
Shearing . . . . .	13
Hoof Trimming . . . . .	15
Reproduction . . . . .	16
Lambing . . . . .	17
Care of Young Lambs . . . . .	20
Weaning . . . . .	21

## STRESS

Minimizing of stress is an integral component of proper management. An animal is stressed if it is required to make abnormal or extreme adjustments in its physiology or behavior to cope with adverse aspects of its environment or management. Physiologically, sheep respond to stress initially with increased heart rates, and, if stress is severe enough, with elevated cortisol levels, thereby increasing feed requirements and reducing immunity. Stress may, therefore, adversely influence their well-being. Some acceptable sheep husbandry practices may cause short-term discomfort and stress as necessary management and health practices are performed. Prolonged animal stress is a concern to the conscientious producer, and if severe, may increase costs to both the producer and the consumer.

Sheep can easily be physically abused because they are relatively docile and lack physical defense mechanisms. Flock owners should handle their animals gently and provide well-designed facilities for handling or moving. Indicators of stress include:

- panting or increased respiration,
- increased susceptibility to disease,
- poor reproductive performance,
- high lamb mortality,
- restlessness, nervousness, or other abnormal behavior,
- teeth grinding,
- poor growth rate,
- poor quality fleece,
- increased flight zone.

Gathering sheep into a common area for treating health concerns, sheltering, transporting, feeding, watering, lambing, shearing, identifying, or other acceptable management practices are not considered serious stress related activities, if conducted with the precautions outlined in this booklet.

## BEHAVIOR

Knowing and understanding the behavior of sheep allows managers to improve both production and animal welfare. Such knowledge is acquired through years of experience and observation. Behavior traits have also been recorded and studied by researchers. Publications are available which discuss this subject in detail. Some of the most important behavior traits are summarized below.

**Wide-Angle Vision.** Managers should be aware that sheep have a 270-degree visual field and depend heavily on their vision. Therefore managers should use this knowledge to move their sheep effectively and efficiently.

**Reaction to Noise.** Sheep are more sensitive than humans to high frequency noise, and excessive noise may be stressful. Handling procedures should be conducted as quietly as possible.

**Breed Differences.** Individual sheep breeds react differently to handling by people and working dogs. Generally, white-faced wool breeds are more gregarious (flocking instinct) than the other breeds.

**Flight Distance and Flight Zone.** All sheep, regardless of breed, maintain a security zone. If this area, or "flight-zone," is encroached on by a person, predator, or dog, movement away or "flight," by the animal is likely. Size of the flight zone varies, depending on the tameness or wildness of the animal. Sheep that have been raised in a barn and in close contact with people will have smaller flight zones than sheep which seldom see people. Understanding these differences allows a shepherd to manage his or her flock with minimum stress.

**Sheep Movement.** Sheep have a strong instinct to follow the leader, and this behavior can make handling easier. They must be able to see a pathway of escape, and should be able to see other sheep moving in front of them. (See *Environment* section.)

## ENVIRONMENT

Because of their adaptability, sheep are comfortable and productive in many environments. They can be humanely managed on open range lands, in farm flocks, feed lots, or any combination of these management systems.

### **Predator Control**

Predators are an increasing problem in the sheep industry. Sheep lack aggressive behavior and are nearly defenseless to predators. Depredation from dogs and wild animals causes stress, suffering, and death for large numbers of sheep each year.

**Wild species.** Coyotes, mountain lions, bears, grey fox, red fox, Russian boars, feral hogs, eagles, and other predators prey upon sheep. If they do not kill the sheep outright, they may cause death from stress, fright, and injury. Non-lethal tools such as electric fences, guard animals, and other methods can help deter predators. Lethal, approved methods used by knowledgeable individuals may also need to be employed.

**Domestic free-roaming dogs.** Domestic dogs, when allowed to roam free, can kill and maim sheep. As more people move into traditionally rural areas, increasing problems with dog attacks are likely to occur. Public education, workgroups, implementation, and enforcement of leash laws would help to reduce depredation problems. The welfare of both sheep and domestic dogs will be improved if owners are aware of the danger their dogs pose to sheep and are encouraged to keep their dogs under control.

### **Guarding Animals**

Under some management situations, guard dogs, donkeys, and certain other protective animals can be kept with the sheep to deter predation from both wild animals and domestic dogs. Guard animals are not effective in all situations and should be monitored to insure that they do not harm the sheep.

### **Facilities**

Facilities depend on the sheep operation and the environment. Not all the facilities discussed below are necessary in every sheep operation to ensure the safety and well-being of sheep and their shepherds.

Selecting the best site for sheep handling and working facilities is not always easy, and a number of items should be considered. Generally, a sheep working facility should be convenient for access by both the sheep and the shepherd. It should be free-draining and sheltered, if possible. A permanent facility should occupy a central location on the farm or ranch to avoid long drives

for the sheep. Temporary facilities on leased or rented land should have similar characteristics.

If the ranch or farm is large, the facility should be within easy herding distance from the main pastures or sources of feed. When herding sheep on roads, provide for their safety as well as that of shepherds and motorists.

**Corrals and barns.** The corral whether permanent or temporary, should allow free movement and have no sharp projecting objects that could cause harm. A site with a slope of 1/8- to 1/4-inch per foot for drainage is ideal for corrals. Corrals on a steep slope should be avoided whenever possible to prevent undue crowding. Barns used for shed lambing protect animals from rain, wind, and snow but are not necessary in all operations. When housed inside, newborn lambs need a dry and draft-free environment with proper ventilation. If ammonia can be smelled in the barn, ventilation is inadequate. Ridge openings, adjustable wall openings, adjustable ceiling air intakes, and exhaust fans can improve ventilation.

Barn layout should allow natural movement of sheep from one area to the other. This reduces stress on both the sheep and their handlers. A shed lambing system might include an area for ewes one to three weeks from lambing, a drop pen for ewes one week or less from lambing, lambing pens for ewes with lambs less than 72 hours old, and mixing pens for ewes with lambs from 3 to 30 days old. (See *Lambing* section.)

**Chutes.** Topography is important in facility design. Sheep work best into a chute on a slight (1%) up-grade. If the crowding pens and chute run up a slight incline, the rest of the facility can be on level ground.

Stress is reduced if sheep are handled in shade, but they may not move freely when facing bright sunlight. Therefore, the orientation of the facility, particularly the sorting chute, should prevent working sheep into bright sunlight.

A curved chute works better than a straight chute. It prevents the sheep from seeing the truck or dip vat until they are almost in it. A curved chute also takes advantage of the natural tendency of sheep to circle around their handlers. Solid chutes are more desirable than open-sided chutes.

If shades are used above working, sorting, and shearing facilities, they should be solid rather than slatted. Slatted shades are fine in facilities that are familiar to the animals. However, when sheep come into the working area, the "zebra-stripe" pattern cast by a slatted shade will cause balking.

## **Handling Sheep in Chutes and Raceways**

- Traffic in chutes should be in one direction only. Sheep should not be allowed to see individuals traveling in the opposite direction or the animals behind them.
- Curved pathways facilitate movement through chutes. Corners should be gradual rather than at right angles.
- Solid side-walls facilitate movement through chutes. See-through side-walls distract the sheep.
- Allow sheep to see beyond temporary barriers. Gates in the chute should be constructed with see-through materials. Sheep tend to stop short of a dead-end or blind alley if they can't see animals ahead of them.
- Eliminate projections on side-walls to avoid injury to animals.
- Facilities should be uniformly lighted. Avoid shadows, particularly "zebra stripes." Sheep move better from darkened to lighted areas. They will balk at reflections, light shining through slats, gratings, or holes in side-walls.
- Inclines should be gradual and provide good footing. Movement is better going up slopes than down.
- Entry points to chutes should gradually "funnel in" animals. Exit points should abruptly "funnel out" animals.
- Artificial noise-makers facilitate movement but lose their effectiveness if they are overused.

## **Handling Sheep in Corrals and Pastures**

Practices that facilitate the movement of sheep reduce stress.

- Sheep move more readily uphill than downhill.
- Sheep move more readily into the wind.
- Sheep are easier to move if they have a lead animal or a person to follow.
- When moving sheep along a fence or barrier, stay to the side and rear of the flock. If you position yourself directly behind the sheep, they will veer away from the fence in

an effort to locate you. (See *Behavior* section.)

- Use well-trained herding dogs that can move sheep quietly and comfortably. Well-trained and managed dogs can reduce overall stress by gathering and moving the sheep more smoothly and effectively.

### **Space Needs**

Sheep need adequate space to meet their feed and water requirements with room to move freely and comfortably. The *SID Sheep Producer's Handbook* outlines suggested space requirements for sheep (see *References* section).

### **Shelter**

Shelter needs will vary depending on the environment. Shelter is not always necessary because sheep are naturally insulated and can adapt to a broad range of climactic conditions. A hill, a patch of shrubs, or a windbreak planting can break the force of winds, dust, and snow. Trees for shade are useful but they are not necessary. Trees, however, provide valuable shade within a working facility, especially when sheep are handled in warmer weather.

For more information, refer to the Midwest Planning Service's *Sheep Housing and Equipment Handbook*. This handbook can be obtained through local University of California Cooperative Extension offices.

## TRANSPORTATION

The commercial transportation of sheep is regulated by state and federal governments.

Loading facilities should be designed to ensure safe and comfortable movement of sheep from the corrals into the truck or trailer.

Space, or sheep density, is critical when hauling sheep. Sheep should have enough space to enable them to stand up if they fall. Sheep loaded too loosely can be injured if the vehicle makes a sharp turn or sudden stop. Divider panels in a large vehicle are useful in maintaining proper sheep density.

The vehicle should be well ventilated to prevent the buildup of ammonia and exhaust fumes. Ventilation is more critical than temperature when transporting sheep during cold weather. Truck exhaust fumes should be directed above or away from the sheep. Good ventilation minimizes heat stress during hot weather.



## HEALTH

Good nutrition and husbandry are the basis for raising healthy sheep. Healthy sheep are alert, move freely and have a good, even fleece. They will eat and drink well and ruminate, defecate, and urinate normally.

The best way to prevent disease is to prevent it from entering the flock. Purchase healthy stock from reputable sources. When possible, quarantine new sheep for at least three weeks before introducing them into an existing flock. Develop a preventive medicine program by consulting veterinarians, farm advisors, and sheep producers.

Vaccination against diseases that are present in the area protects sheep from death, illness, and suffering and increases profitability. Common times to vaccinate are before breeding, before lambing, and at weaning. Proper storage and administration of vaccines are essential if they are to be effective.

Controlling internal and external parasites promotes flock health. Producers should read and follow the label directions to assure an effective program and to avoid residues. A good time to treat for external parasites, if necessary, is at shearing when the wool is short.

In spite of good preventive medicine programs and proper care, animals may still become sick or injured. Accurate diagnosis allows selection of the proper treatment and helps in deciding what management steps, if any, are needed to prevent the spread of disease in the flock. Diagnostic services can be obtained from local veterinarians and through the California State Veterinary Diagnostic Laboratory System. Sick animals should be isolated to minimize the spread of disease. Isolation also makes it easier to observe and treat affected animals. When using health care products, it is essential to read and follow the label instructions. A record of health care product usage can be useful in developing and documenting an adequate health care treatment plan. Prompt and appropriate disposal of dead animals is important for herd health.

## NUTRITION

Sheep diets will vary, depending on location and management practice. Sheep are ruminants, and use a wide range of plants to meet their nutrient needs. Diets include native forage grazed from range land in the mountains or desert; crop aftermath from grains, vegetable crops, or alfalfa; alfalfa hay; irrigated pasture; and rations that contain a high proportion of grains and by-products from the human food chain. All of these feeds, in the proper proportion, provide adequate amounts of nutrients for sheep.

### Nutrients

The nutrient needs of sheep depend on age, sex, and the stage of production. Young animals require a diet high in energy and protein for proper growth and good health. The requirements for energy and protein gradually decrease as an animal reaches maturity. However, nutrient requirements increase for ewes in later stages of pregnancy and increase even more in the early stages of lactation. The energy and protein requirements for a mature lactating ewe with twins is about two times that of a mature ewe that is not pregnant or lactating. The nutrient requirements for sheep at the various stages of production are given in detail in the National Research Council Publication, *Nutrient Requirements for Sheep*, 1985.

The following nutrient groups are required by sheep:

**Water.** Water is an essential nutrient. Sheep should have a clean, abundant supply -- approximately one gallon of water per day per mature animal. If succulent, high moisture feed is available, sheep may not need supplemental water.

**Energy.** Energy requirements are affected by such factors as age, level of production and activity of sheep. Sheep get most of their energy from range forage, pasture, hay and other roughages. By-products and crop aftermath can also provide energy for sheep.

**Protein.** Because sheep are ruminants, protein quality is not as critical as it is with monogastric species such as pigs and humans. Rumen microorganisms (bacteria and protozoa) convert poor-quality protein in the diet into high-quality protein. The ruminant animal can even convert non-protein nitrogen into high quality protein when sufficient soluble carbohydrates are available. Certain by-products are an excellent source of protein. Roughage can provide adequate protein, depending on the stage of maturity of the plants and the sheep's level of production. Protein is required for growth, reproduction, lactation, and maintenance of the body.

**Essential Fatty Acids.** This nutrient group is of little concern for ruminants, because of their diet and the rumen microorganisms. Rumen microorganisms can produce the major portion of essential fatty acid requirements.

**Minerals.** Minerals are inorganic elements that are required for normal body function and growth. Most diets meet the requirements of this nutrient group. However, some geographic

areas are low in some minerals. Generally, growth and production is reduced by mineral deficiencies, and producers should supplement deficient minerals to insure animal health and an adequate level of production.

**Vitamins.** Vitamins are essential organic compounds that are usually supplied in the diet. These compounds are essential for good health and production. There are two types of vitamins, fat soluble (A, D, E, K) and water soluble (B-complex). The rumen organisms will produce enough B vitamins to meet animal requirements. Sheep consuming green roughage will receive adequate amounts of fat soluble vitamins.

## **Feeding**

Grazing sheep should have ample forage to meet their daily feed requirements.

Sheep that are fed in mangers should be provided adequate space while feeding. The space requirements for different ages of sheep and different feeding conditions can be found in the Sheep Industry Handbook.

The nutritional status of sheep can be monitored by observing expected growth rates and size of sheep for a given age. These two factors are important in evaluating the nutritional status of sheep. Slight deficiencies in minor nutrients will retard growth. Also, over-feeding can reduce production and jeopardize good health.

Producers should be able to recognize the symptoms of toxicity. Poisonous plants or an excess of certain nutrients can cause toxicity.

## IDENTIFICATION

Depending on the type of sheep operation, sheep may need to be identified. Paint branding is used for identification under some types of management. When this type of identification is needed, scourable paint is used. Ear tags, ear marking, ear tattoos, flank tattoos, and nose brands provide more permanent identification. Tattoos and nose branding are the most permanent type of individual identification.

## SHEARING

Shearing sheep contributes directly to the welfare of both animal and owner. The obvious return to the owner is the marketable product, wool. Shearing is necessary to enhance the physical welfare of the animal, as domestic sheep do not shed their wool naturally. Immediate returns include greater comfort, particularly in hot weather, and the correction of "wool blindness" in closed-faced breeds. Other benefits include:

- improved cleanliness and health,
- greater production efficiency,
- better reproductive efficiency,
- improved bonding between ewe and lamb and increased survival and performance of the lambs.

Some of these benefits do not require full shearing and can be obtained through crutching (tagging) or facing. (See *Lambing* section).

### Facilities and Equipment

Shearing practices vary. Some needs, however, are universal:

**Holding areas, crowding chutes, and alleyways.** These should be clean and dry and should provide for free-flow and easy catching of the sheep without physical injury or undue stress to animal or handler.

**Shearing floor.** A firm, non-slick surface will enhance the shearer's comfort and control. Even if this "floor" is only a sheet of plywood, it should be kept clean. If plywood is used, you may want to provide your own rather than allow use of one that has been used for other flocks. This will cut down on disease introduction. Shade and good ventilation are also beneficial to both sheep and shearer.

**Sanitary shears.** The shearer should disinfect all shears before starting on a flock to prevent disease transmission, especially of boils (caseous lymphadenitis). Even within-flock, blades should be changed and disinfected after shearing a sheep with boils before starting on the next animal.

**Shearers.** Adequately trained and experienced personnel shearing and handling sheep will improve the value of the wool clip and contribute to the animal's welfare. Ability to properly position the sheep and maintain control is important. Selecting a reputable sheep shearer or a shearing crew is important to insure that the sheep are handled properly during shearing.

## Sheep Management

**Before shearing.** Sheep may be held in a drylot away from feed and water before shearing begins. A 12-hour fast to reduce stomach fill is common practice. This increases the animal's comfort during shearing, makes handling and control easier and may prevent injury. A full stomach puts pressure on such vital internal organs as the heart, lungs, and liver. This pressure can be increased during handling for shearing.

- Sheep should not be shorn when the fleece is wet. Wet sheep are difficult to handle and control and the wool value can be reduced.
- It may be beneficial to group sheep for shearing, separating young sheep and shearing them before the older ewes. This helps reduce disease transmission, especially boils.

**Post-shearing.** In harsh environments it may be necessary to provide shade or shelter for two or three days after close shearing. Sheep are very adept at finding their own protection using natural terrain and objects such as ravines, rocks, and trees. If these are not adequately available, protection may need to be provided. The need for added protection may be reduced by using a rake comb on the hand piece of the shears, to leave about 1/4 of an inch of wool on the sheep. This requires greater care and skill during shearing.

## HOOF TRIMMING

Under conditions where the terrain does not provide sufficient wear to keep the hooves properly shaped, periodic hoof trimming improves comfort and movement and prevents lameness from overgrown hooves.

Hoof trimming can also be a useful method of early diagnoses and treatment of foot rot. Foot rot is a disease that is caused by the bacterium, *Bacteroides nodosus*. The disease requires the interaction of this bacterium, found in the sheep's foot, with another bacterium in the soil. Hoof trimming can expose the bacterium, then chemicals and medications are applied to the hoof for treatment. In flocks free of foot rot, regular trimming may not be required. Some terrain and soil conditions provide enough natural wear to keep hooves properly shaped. If excess hoof material is present, it should be removed to prevent structural unsoundness and discomfort, even in the absence of infection. Thorough discussion of foot rot and its control can be found in many publications, including those listed in the *Reference* section.

All additions to a flock should follow a trimming-treating-isolation program to prevent introducing the disease into the flock. Periodically re-examine the animal during the quarantine period, which should last for at least two weeks.

## REPRODUCTION

Several husbandry practices improve sheep reproductivity, as well as their health and well-being.

### Marking Ewes

Rams may be equipped with devices that mark the ewe's rump at breeding time. These devices enable the producer to estimate when the ewes are due to lamb. Accurate lambing dates will enable the producer to have equipment and health care products available, to ensure proper care of lambs upon delivery.

Several devices can be used to mark ewes. They all work well if managed properly. The breeding, or marking, harness is strapped to the ram's brisket and is equipped with a piece of marking chalk. The harness should be checked frequently for proper adjustment and prevention of skin irritation. Another method of marking ewes is to cover the ram's brisket with a light oil mixed with a pigment or dye.

### Breeding Ewe Lambs

Ewes can be bred to lamb at approximately one year of age if they are fed to meet the nutrient requirements for a growing ewe, developing fetus, and lactating ewe. These young ewes require more attention than more experienced ewes at lambing, to insure the health and well-being of ewe and lamb. Ewes that lamb as yearlings tend to be more fertile and produce more lambs in a lifetime than ewes that are bred to lamb as two-year-olds.



## LAMBING

The relationship between animal care and production is probably most crucial during lambing.

### Preparing for the Lambing Season

**Tagging or shearing.** About one month before the lambing season begins, ewes may be tagged or shorn to benefit both shepherd and animal. The choice of which practice to use, or whether either is needed, will be dictated by both environmental and management considerations. Both ewe and fetus are more susceptible to injury during late pregnancy, so animals should be handled with care during shearing or tagging.

**Tagging** (crutching) is the shearing or clipping of wool from around the ewe's vulva, udder and flanks. Some advantages of tagging are listed below:

- makes it easier to observe the signs of approaching birth and allows the shepherd to be prepared to assist ewe and lamb, if needed;
- provides for a more sanitary birth by reducing sources of contamination as the lamb leaves the birth canal;
- makes it easier for the newborn lambs to locate a teat and ingest the critical first meal, rather than mistakenly sucking on a lock of wool that may be contaminated with dung or other foreign material;
- makes it easier for the shepherd to tell if the lamb has begun nursing.

**Shearing** the entire ewe before lambing is practiced by some, particularly if lambing sheds or barns are used. Shearing provides all of the benefits of tagging. In addition, it:

- keeps the lambing shed cleaner and drier;
- makes shed-lambing ewes less likely to lie on their newborn lambs;
- reduces the likelihood of heat stress experienced by some shed-lambing ewes;
- causes the ewe to be more sensitive to the weather and to seek a sheltered place to lamb. However, it requires the manager to make sure that shelter is available, and may, in cold weather, require additional feed to produce body heat.

**Ewe band management.** In large flocks, it is advisable to group ewes by expected lambing date. The groups closest to lambing can then be provided any special care needed. As lambing

approaches, the drop band may be penned at night for close observation. Illustrated descriptions of these signs can be found in various publications and media, such as those listed in the *References* section.

**Preparing the facilities.** For range or pasture lambing in a harsh environment, shade, shelter or windbreaks may have to be provided, if natural terrain and objects (trees, rock outcroppings, etc.) do not provide needed protection. If lambing is to take place in sheds or other confined areas, it may be necessary to clean and disinfect the area and facilities. Old bedding materials should be removed and the surfaces allowed to dry before spreading new bedding.

Lambing pens should be in good repair and large enough to allow the sheep to turn around, preclude injuries, and provide a good environment for ewe-lamb bonding. Feed and water troughs or buckets should be located so that lambs will not fall in or be trapped.

### Care Practices During Lambing

Unassisted lambing is preferable for both the animal and shepherd. However, if the delivery does not proceed normally, intervention may be needed. It is important to know and understand all aspects of a normal delivery to be able to recognize deviations that might dictate intervention. These considerations include the correct presentation of the lamb in the birth canal, the sequence in which events should occur, and the expected time lapse between these events.

**Assistance during delivery.** The birth process is normally completed approximately one hour after the water bag appears. Delayed lambing may be due to improper presentation of the lamb, the lamb being too large for the pelvic opening, entanglement of twin lambs in the uterus or vagina, or inability of the ewe to contract due to exhaustion.

In such instances, intervention by the shepherd is essential to the welfare of both ewe and lamb. An excellent illustrated description of a normal birth, of abnormal presentations, and of how assistance should be given, can be found in *A Handbook for Raising Small Numbers of Sheep*. (See *References* section.)

**Assistance immediately after lambing.** The natural instincts of ewe and lamb are usually adequate. The lambing procedure that will cause the least amount of stress to the ewe and the best survival rate for the lambs will vary, depending on weather conditions, the breed of sheep, and the management system being used. The management level required during lambing will range from ewes giving unassisted birth with little monitoring, to intensely managed systems where the ewe will be monitored, and assisted when needed, through the entire birth and post-birth process. Shepherds may have to assist in the following procedures:

- Clean the birth membranes away from the lamb's nose and mouth if the ewe fails to do so. Check that airways are open and that the lamb is breathing properly.

- Place the ewe and lambs in a lambing pen after lambing. This is normal procedure for shed lambing and may be necessary in pasture or range lambing if ewes or lambs need assistance.
- Early nursing is important, both for nutrition and for the disease resistance provided by antibodies in the ewe's colostrum. Ensure that all lambs nurse soon after birth. It may be necessary to check the ewe for open teat canals and milk production, ability to stand to be nursed and acceptance of her lamb. The lamb should easily stand and locate the udder. If lambs are not able to nurse, assist them with the ewes, or use a bottle or esophageal probe. If necessary, "borrow" colostrum from another ewe, or keep a supply in your freezer to be thawed and used if needed. Cow colostrum, although not ideal, will work when nothing else is available.
- Trim the lamb's navel cord and treat the stump with a seven percent iodine solution. This will minimize infection entering the newborn through this still-open channel.
- Promote bonding between the ewe and her lambs. Often "granny" ewes will attempt to steal a newborn lamb and break that bond. In multiple births, the ewe may fail to claim one or more of her lambs. Lambing pens may help prevent or cure this. Restraint of the ewe may be needed for lamb acceptance. Methods of restraint may cause temporary discomfort, but are beneficial to the overall welfare of ewe and lamb. Twin-tying may also be used to promote this bonding. Tying one leg of one twin to a leg of the other with a short piece of soft rope will allow free movement, but prevent one twin from being abandoned and starving to death on open range or pasture situations.

## CARE OF YOUNG LAMBS

### Raising Orphan Lambs

It may be necessary to raise a lamb away from its natural mother. Death of the ewe or her inability or unwillingness to nurse any, or all, of her lambs, requires that a substitute be found. This may be done by "grafting" the lamb to another ewe that has recently lambed, or by artificial rearing on a bottle or lamb bar facility. For both economic and welfare reasons, grafting may be the most desirable.

There are many acceptable ways to accomplish a graft. These include stanchion grafting, hide grafting, slime grafting, wet grafting, and stocking grafting. All have their advantages and drawbacks, but all are preferable to lamb starvation or ewe health problems resulting from udders not being nursed. More details can be found in the publications listed in the *References* section.

### Lamb Marking

Lamb marking is a management practice that may involve castration, docking, identification, vaccination, and other health procedures. These processes should be performed by a skilled individual. Good hygiene should be practiced for the sheep and equipment used during docking and castration, and for several days after the operation. These practices should be performed at an early age. However, weather conditions may dictate the timing of these practices. Marking may be delayed because of extreme weather conditions such as a heat-wave, cold rain, or snow. Postponing marking until conditions are more favorable will reduce the likelihood of health problems. More details can be found in the publications listed in the *References* section.

**Docking.** Docking can be done using several techniques. Docking should be performed by or under the supervision of a skilled person. Cleanliness of the animal is the main reason for docking. Sheep with long wool and long tails become contaminated with urine and feces. Wet wool is a good breeding site for flies. Fly maggots can invade the sheep's flesh and become life-threatening if they are not controlled. Docking drastically reduces the incidence of maggots in sheep.

**Castration.** Young, intact (not castrated) ram lambs will mount or ride ewes in estrus, causing stress for both the ewes and rams. These lambs are castrated to reduce stress on ewes and young males. Indiscriminate breeding by young rams makes it impossible for the producer to maintain breed integrity and to prevent the inbreeding of animals.

## WEANING

Lambs can be weaned at an early age, if they are eating harvested feed. Early weaned lambs should receive a ration high enough in nutrients to meet their growth maintenance requirements. Under some conditions, early weaning is in the best interest of the welfare of the ewes and lambs.

To minimize stress, lambs should be left in the area they're accustomed to and ewes moved to a different area. Lambs should be fed a high-quality feed before, during, and after weaning. The ewe's feed and water should be restricted at weaning to reduce the chance of udder damage.

After weaning, lambs should be placed on the best pasture or feed available, to maximize growth. Ewes should be placed on a lower quality pasture. This will allow the ewes carrying harmful, excessive fat at weaning to lose the weight before breeding.

## REFERENCES

- Baldock, M.M. and R.M. Sibly, 1990. Effects of handling and transportation on the heart rate and behavior of sheep. *Appl. Animal Behav. Sci.* 28:15-39.
- Church, D.C., et. al. Digestive Physiology & Nutrition of Ruminants, *Practical Nutrition*, Vol 3. 1972.
- Frazer, D., J.S.D. Ritchie, and A.F. Fraser, 1975. The term stress in a veterinary context. *Brit. Vet. J.* 131:653.
- Kilgour, R. and H. de Langen, 1970. Stress in sheep resulting from management practices. *Proc. N. A. Soc. Anim. Prod.* 30:65-76.
- Ley, S.J., A. Livingston and A.E. Waterman, 1991. Effects of chronic lameness on the concentrations of cortisol, prolactin, and vasopressin in the plasma of sheep. *Vet. Rec.*, 129:45-47.
- Livestock Poisoning Plants of California*, University of California Publication 21268.
- Livestock Trucking Guide*, Livestock Conservation Institute, 1988
- Livestock Handling Guide*, Livestock Conservation Institute, 1988
- Nutrient Requirements for Sheep*, National Research Council Publication, 1985.
- Phillips, R.L., B. Lane, J. Glenn, and E.C. Loomis. 1985. *A Handbook for Raising Small Numbers of Sheep*, University of California, publication # 21389.
- Sheep Industry Development Program, Inc. 1988. *SID Sheep Production Handbook*. Denver.

## GLOSSARY OF SHEEP TERMS

- Black face breeds** - Meat breeds of sheep.
- Booster vaccination** - A second or multiple vaccination given to increase an animal's resistance to a specific disease.
- Breech birth** - A birth in which the hind feet of the young are presented first.
- Breed** - Animals of like color, body shape, and wool grade similar to those of parents.
- Bummer or orphan** - A lamb not raised by its mother; usually it is fed from a bottle.
- Castration** - Removal of male sheep testes.
- Colostrum** - First milk a ewe gives after birth. High in antibodies, this milk protects newborn lambs against diseases.
- Condition** - Amount of fat and muscle tissue on an animal's body.
- Creep** - A feeding area where lambs can feed but ewes are excluded.
- Crossbreed sheep** - A sheep resulting from the mating of two different breeds.
- Crutching** or tagging (verb) - Removing wool from the inside of a sheep's back legs and belly.
- Crutchings** (noun) - Wool removed from the sheep during the crutching or tagging process. This wool usually is free of manure, as opposed to tags which contain a lot of manure.
- Dam** - A female parent.
- Dock** (noun) - Stub end of the sheep's tail.
- Docking** (verb) - To remove the sheep's tail.
- Drench** - A means of giving liquid medicine by mouth.
- Energy** - A nutrient category of feeds usually expressed as TDN (total digestible nutrients).
- Estrus** - The time that the ewe is receptive to the ram and can conceive.
- Ewe** - A female sheep.
- Farm flocks** - smaller numbers of sheep raised on a family-owned farm.
- Feedlots** - an area where sheep are kept and fed harvested feeds.
- Fleece** - Wool as it is shorn from the sheep.
- Flushing** - Increasing the nutrition of a ewe before and during the breeding season.
- Fly strike** - When green and blue blowflies lay eggs in wet and stained wool and maggots develop.
- Gestation** - Pregnancy.
- Graft** - A procedure to get a ewe to accept a lamb that is not her own.
- Granny ewe** - A pregnant ewe close to lambing that tries to claim another ewe's newborn lamb.
- Lactation** - The period when the ewe is giving milk.
- Lamb marketing** - husbandry practices which may involve castration, docking, identification, vaccination, and other health procedures.
- Lamb** - Young sheep of either sex under one year of age..
- Lambing pen** - A small pen where a ewe and her lambs are put after birth.
- Larvae** - Immature stages of a parasite. The term applies to insects, ticks, and worms.
- Ovulation** - When an egg is released from the ovary.
- Parturition** - Act of giving birth.
- Protein** - A nutrient category of feed used for growth, milk, and repair of body tissue.
- Puberty** - When a sheep becomes sexually mature.

**Quarantine** - To isolate or separate an animal from other sheep.

**Range land operations** - larger numbers of sheep raised on open range lands and/or large acreage.

**Ram** or buck - Male sheep of any age that has not been castrated.

**Ration** - Total feed given an animal during a 24-hour period.

**Seasonal breeders** - Ewes only showing estrus during part of the year; estrus season depends on breed and climate.

**Tags** - Heavy, manure-covered locks of wool.

**Wether** - A male sheep castrated before the development of secondary sex characteristics.

**White face breeds** - Wool breeds of sheep.





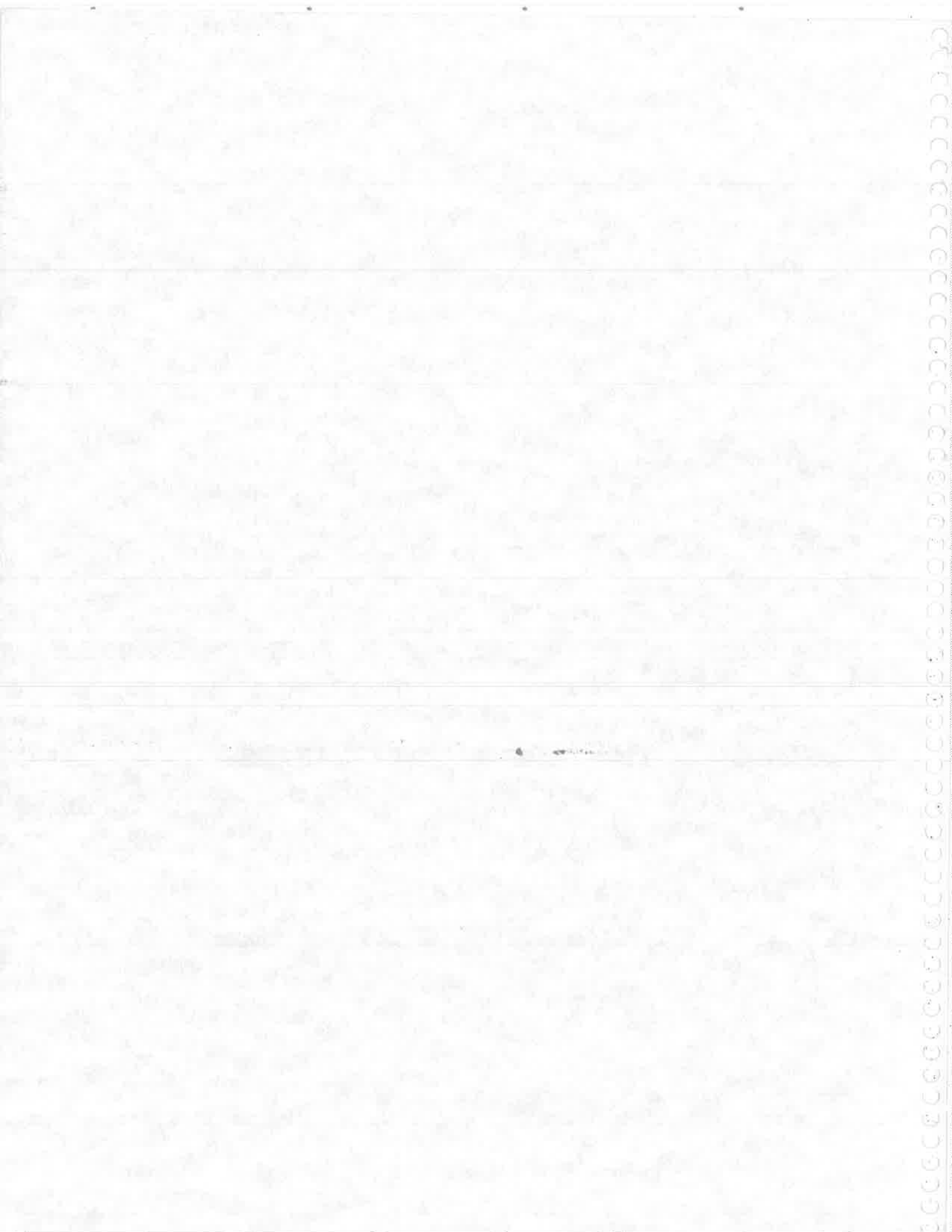

# CONTENTS

<b>List of Management Activities</b>	<b>6</b>	<b>Flock Health</b>	<b>30</b>
<b>Breeds of Sheep</b>	<b>7</b>	Stress; General Sanitation	
Fine Wool; Medium Wool; Long Wool; Meat Breeds; Other Breeds; Crossbreeding		<b>Diseases</b>	<b>31</b>
<b>Management Practices</b>	<b>8</b>	Basic Disease Control Measures; Sanitation, Quarantine, Isolation, Testing, Culling, Nutrition, Vaccination, Management	
Culling Ewes; Bad udder, Thin ewes, Teeth and age, Defects Selection; Older ewes, Strong feet and legs, Body, Birth rate, Wool quality, Genetic defects, Rectal prolapse, Cryptorchidism, Skin folds, Wool blind, Breed standards		Common Disease Complexes; Abortion, Vibriosis, Enzootic abortion of ewes; Epididymitis, Mastitis, Navel ill, Pneumonia, Scours	
<b>Reproduction</b>	<b>10</b>	Specific Diseases; Bluetongue, Boils, Enterotoxemia, Foot rot, Pregnancy toxemia, Soremouth, Tetanus, White muscle disease	
Breeding Season; Estrus or Heat Cycle; Gestation; Puberty; Fertility; Heredity, Age of ewe, Light, temperature, and humidity, Association with ram, Nutrition, Flushing, Diseases and parasites		Sample Sheep Herd Health Program	
<b>Breeding</b>	<b>12</b>	<b>Parasites</b>	<b>36</b>
Preparing the Ewe; Worming, Keeping ewes cool, Weight gain, Overeating disease (enterotoxemia), Tagging		External Parasites; Ticks, Lice, Blowflies and wool maggots, Nose bots	
Preparing the Ram; Condition, Cooling, Soundness		Internal Parasites; Feces collection for laboratory analysis.	
Recording Breeding Dates		Specific Internal Parasites; Coccidiosis, Roundworms in stomach and intestines, Roundworms in lungs, Liver flukes, Tapeworms in intestines	
<b>Lambing</b>	<b>13</b>	<b>Wool</b>	<b>42</b>
Preparing Lambing Shed; Protection for Newborn; Lambing Jugs or Jails; Checking Ewes at Lambing; Sign of Lambing; Helping the Ewe		Grades	
Care of Ewe and Lamb After Birth; Clearing airways, Stillbirth, Ewe's care of lamb, Checklist for ewe at lambing, Make sure lamb nurses, Nursing weak lambs, Identify lambs		Factors Reducing Wool Value; Foreign materials, Plastic or plastic fibers, Stains, Other factors	
Grafting; Slime graft, Stanchion graft, Hide graft, Other types of grafting		Wool Management; Shearing area, Tying fleece, Prevent plant material contamination, Reduce wool stains, Prevent plastic contamination, Branding paint contamination, Black wool contamination, Feed affects wool	
Raising Orphan or Bummer Lambs		Packaging Wool; Sheep Management Before Shearing; Shearing Time	
<b>Lamb Management</b>	<b>23</b>	<b>Fencing for Sheep</b>	<b>45</b>
Castration and Docking; Elastrator, Knife method, Hot knife or chisel docking, Burdizzo castration and docking, Holding lambs for castration and docking		<b>Marketing</b>	<b>46</b>
Treating Inverted Eyelids; Cutting method, Bloodless method, Injection method		<b>Appendix A</b>	<b>47</b>
Creep Feeding Lambs; Creep feeds, Advantages to creep feeding, Creep feeding and overeating disease		Sheep Equipment	
Weaning Lambs		<b>Appendix B</b>	<b>51</b>
<b>Nutrition</b>	<b>26</b>	General Tips on Feeding, Facilities, and Management for Sheep	
Major Nutrients Sheep Need; Water, Energy, Protein, Minerals, Vitamins		<b>Appendix C</b>	<b>51</b>
<b>Feed Requirements</b>	<b>27</b>	Foot Rot Eradication	
Feeding Ewes; Evaluation of ewe's condition, Condition and ewe's requirement, Maintenance diet, Late pregnancy needs, Diet for the last 6 weeks of pregnancy, Diet for the first 8 to 10 weeks of lactation, Weaning time, Ewe's needs before breeding		<b>Appendix D</b>	<b>53</b>
Feeding Replacement Ewe Lambs; After breeding		References	
Feeder Lambs; Ram Feed Requirements		<b>Glossary of Sheep Terms</b>	<b>54</b>

**Fine Wool**

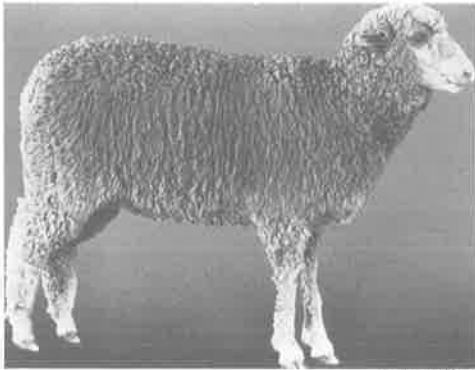

**Debouillet**



**Delaine Merino**

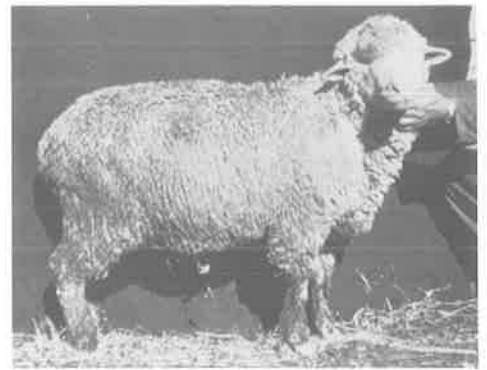

**Merino**

**Medium Wool**

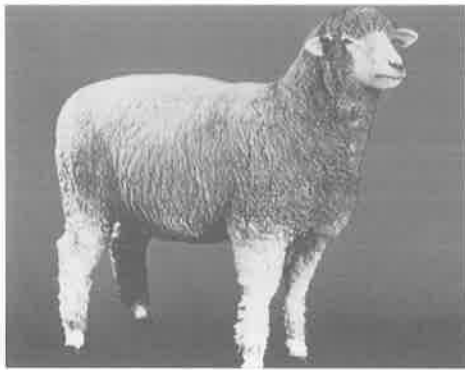

**Columbia**

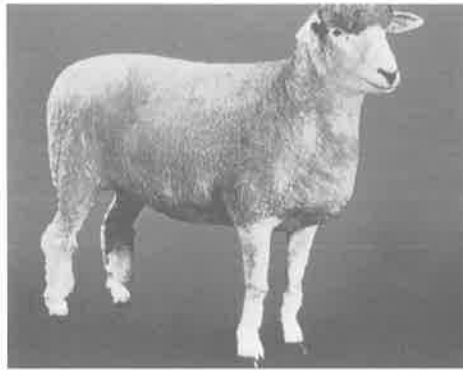

**Corriedale**

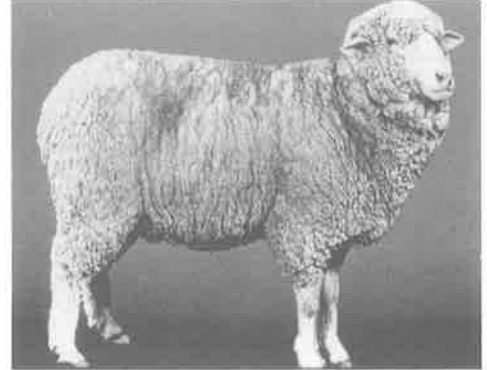

**Targhee**

**Meat Breeds**

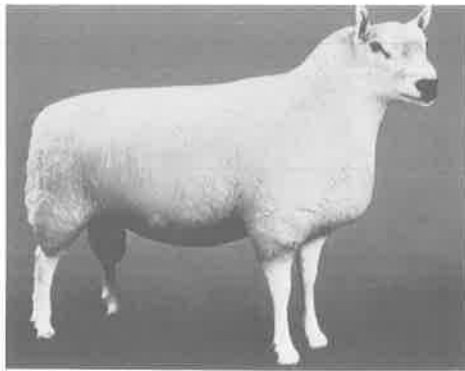

**Cheviot**

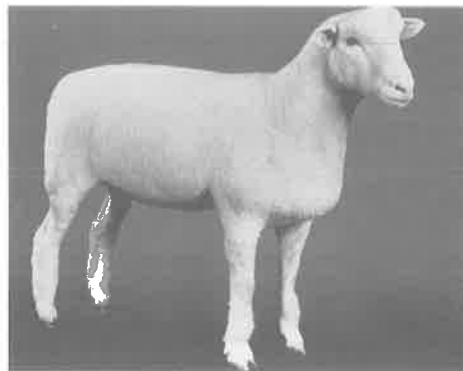

**Dorset**

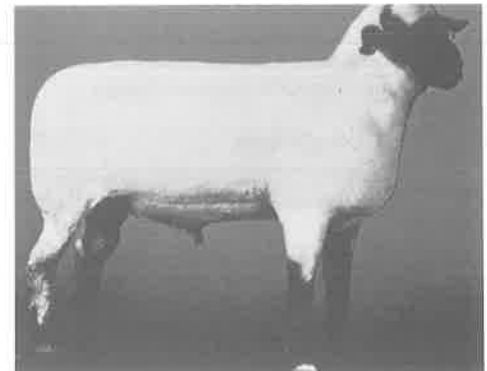

**Hampshire**



**Oxford**

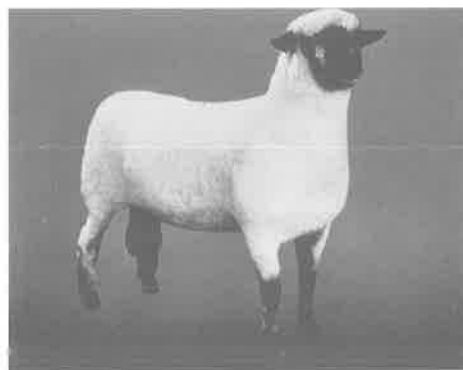

**Shropshire**

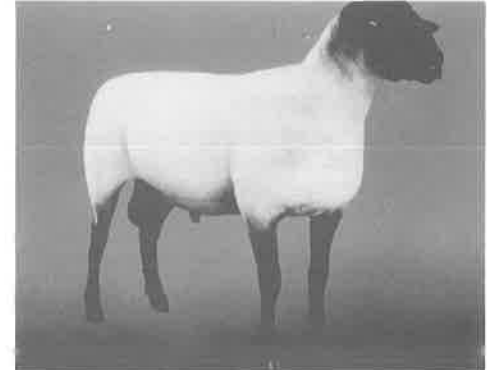

**Suffolk**

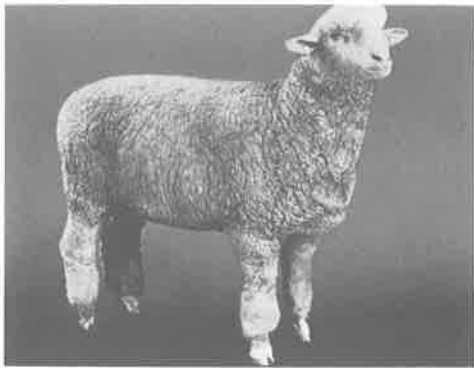

Rambouillet

Fig. 1. Major breeds of sheep in the United States. (Reprinted from *The Sheepman's Production Handbook*, Sheep Industry Development Program, Colorado, 1970.)

**Long Wool**

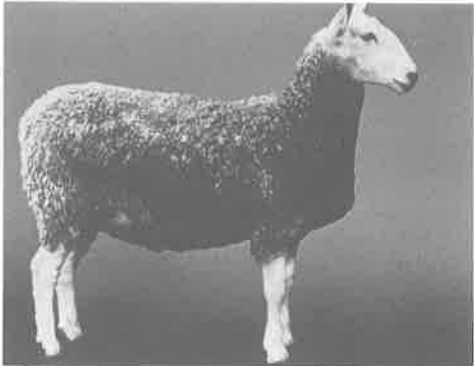

Border Leicester

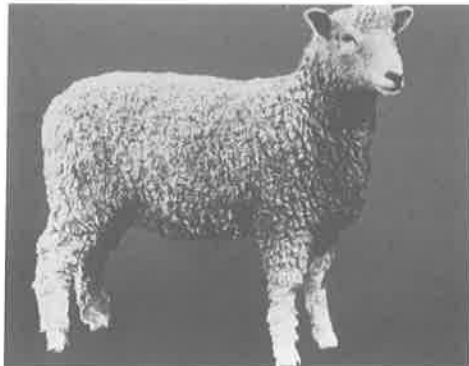

Lincoln



Romney

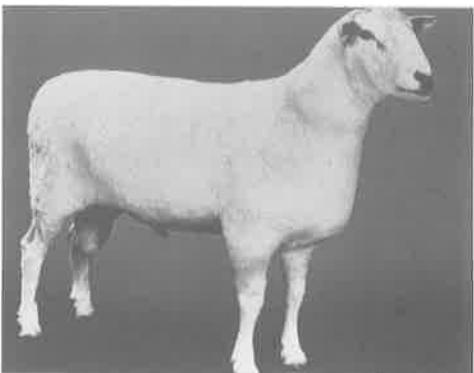

Montadale

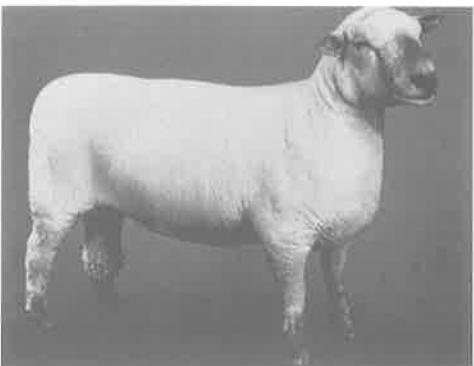

Southdown

**Other Breeds**

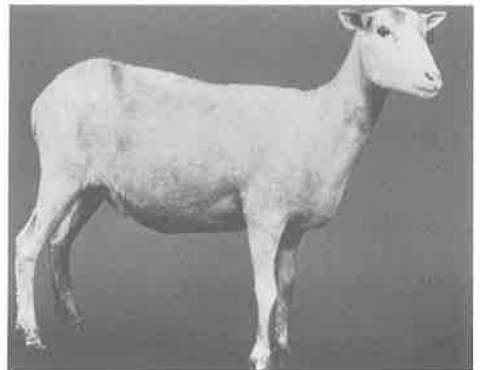

Finnish Landrace

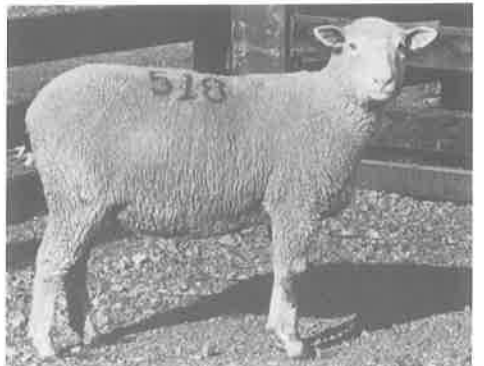

Polypay

# LIST OF MANAGEMENT ACTIVITIES

---

## **Prebreeding Management for Ewes and Rams**

Vaccinate for abortion diseases  
Worm ewes  
Flush ewes 2 to 3 weeks before breeding  
Check condition of rams; provide extra feed if in poor condition  
Vaccinate rams for epididymitis; check with veterinarian  
Trim hooves  
Semen test rams and check testicles

## **Breeding Management**

Tag ewes (if dirty)  
Turn rams in with ewes  
Use color marking methods for rams  
Take rams out 90 days after first exposure to ewes

## **Prelambing Management**

Worm ewes, check with veterinarian  
Examine condition of ewes  
Increase feed to ewes  
Tag ewes for lambing  
Prepare barn and equipment for lambing  
Vaccinate ewes for enterotoxemia

## **Lambing Management**

Watch ewes carefully. BE THERE!!!  
Vaccinate lambs; consult veterinarian  
Trim hooves as ewes lamb or shortly after lambing season  
Wean lambs at proper weight

## **General Management**

Trim hooves  
Shear ewes  
Shear lambs  
Plan feed supply for winter  
Consult with veterinarian for vaccination and worming schedule

# BREEDS OF SHEEP

---

Sheep breeds have been developed to fit almost every environmental condition in the world. This section will discuss the more popular breeds in the United States. (See fig. 1 for pictures of major sheep breeds in the U.S.)

Generally, breeds can be broken down into four groups: fine wool, medium wool, long wool, and meat breeds.

## Fine Wool

The most widely used fine wool breeds, Rambouillet and Merino, originated in the dry, arid regions of Spain and live mainly in range conditions.

### Advantages

- Rugged; adapt well to extreme heat and cold; do well under poor feed conditions.
- Produce high quality fine wool.
- Excellent herding instincts; band together.
- Long breeding season: April, May, June, and July for lambing early in the fall.
- Long-lived; ewes may live 10 to 12 years.

### Disadvantages

- Not heavily muscled; poor body conformation.
- With high rainfall and on irrigated pasture, hoof growth is more rapid and more extensive than in most breeds, thus requiring frequent trimming.
- Not a breed of choice in high rainfall areas because of wool rot and fly strike.

## Medium Wool

Medium wool breeds were bred for both wool and meat. They were developed by crossing fine wool breeds with long wool breeds. Fine wool breeds were used for wool quality and long wool for growth and body conformation. Medium wool breeds are used mainly in the range sheep industry. About 35 percent of the sheep in the United States are these breeds. The most common of these breeds in the West are Columbia, Corriedale, and Targhee. The Panama is less numerous.

### Advantages

- Compared with fine wool breeds, lambs grow faster, reach market at a younger age, and have better body conformation.
- Produce more pounds of wool and cleaner wool than fine wool breeds; wool is not as fine as that of fine wool breeds but is fine enough to receive a high price.
- Ewes are good milkers with adequate feed.
- Good herding instincts.

### Disadvantages

- Do not produce well in extremely warm climates.
- Require more feed and are not as rugged as fine wool breeds.
- Shorter breeding season than fine wool breeds.

## Long Wool

Long wool breeds were developed in the British isles under cold, moist conditions, and where the feed supply is abundant. They are less popular in the United States and do not adapt well to most California conditions. The most popular long wool breeds are: Romney, Lincoln, Cotswold, Leicester, and Border Leicester.

### Advantages

- Grow to large size as adults.
- Lambs grow fast but mature late.
- Ewes are heavy milkers.
- Adapt well to heavy rainfall areas.
- Produce a heavy, coarse clip.

### Disadvantages

- Low demand for coarse wool.
- Mature late and are very seasonal in their breeding habits.
- Lack herding instincts.
- Lambs do not produce as desirable a carcass as meat breed sheep.

## Meat Breeds

Meat breeds were developed primarily for lamb production and are usually found under farm flock management. Meat breed rams, particularly Suffolk, Hampshire, and Suffolk-Hampshire Crossbreds are bred to range ewes to increase lamb production. Crossbred ewe lambs produced in this cross are usually sold as market lambs. The most popular meat breeds are Suffolk and Hampshire. Dorset, Cheviot, and Montadale are not as popular. Shropshire, Oxford, and Southdown are other less popular breeds.

### Advantages

- Lambs have excellent body conformation and grow fast.
- Ewes are prolific, good milkers, and good mothers.

### Disadvantages

- Ewes are later breeders compared with Dorsets or fine wool breeds.
- Produce a light clip of wool.
- Herding instincts are poor.

## Other Breeds

The Finnish Landrace (Finn) breed is a recent introduction to the United States. "Livability" of the Finn lambs is high. Purebred ewes can have from three to seven live, healthy lambs. Lambs appear to have the ability to absorb more antibodies from colostrum during the first 24 hours of life, thus increasing their livability. This breed, however, has poor body conformation and grows slowly. The wool is of very poor quality. Finn sheep have been used very successfully in crossbreeding to increase the number of lambs born. One-half blood Finn ewes can produce about a 250 percent lamb crop. A one-fourth or quarter blood ewe can produce up to 200 percent lamb crop. When the Finn is crossed with the

the proper breed, conformation and wool quality can be improved.

The Polypay breed was developed at the Science and Education Administration (United States Department of Agriculture) Sheep Experiment Station at DuBois, Idaho, from Finn, Dorset, Rambouillet, and Targhee to incorporate the advantages of these breeds. Polypay ewes can produce a 175 to 200 percent lamb crop, or higher.

## Crossbreeding

Most farm flock operators have meat breed ewes for the production of lambs. There has been a bias against the medium wool sheep in farm flocks; however, a good meat-medium wool crossbred ewe can be very productive. Crossbreeding does increase lamb numbers. Also, use of medium wool sheep in crossbreeding can increase returns from wool with little or no reduction in lamb growth.

# MANAGEMENT PRACTICES

## Culling Ewes

**Bad udder.** Ewes that do not produce and raise at least one lamb per year should be culled as should ewes with bad udders (lumps) that cannot raise twins. Culling poorly producing sheep can be a problem in small flocks, because often there is sentimental attachment to the ewes, but it is necessary to improve profit and production. Lambing, weaning, and breeding are good times to identify ewes for culling.

**Thin ewes.** Some ewes develop *thin ewe syndrome*, a condition caused by bacteria or a virus. The ewes usually are very thin no matter how well fed. If they have been treated for internal parasites and still are thin, it would be wise to cull them because they will be poor producers or may die.

**Teeth and age.** Ewes with missing teeth (*broken mouth*) may have to be culled. Ewes with missing teeth can graze pasture, if the pasture is not too coarse or mature. If they are kept, their front teeth may be pulled. "Smooth mouth" ewes can graze better than ewes with part of their teeth missing.

**Defects.** A good ewe should produce good, healthy lambs for the first 6 to 7 years of her life. Some will continue to be good producers beyond this age. Figure 2 should give you an idea of how to age ewes.

Ewes that produce inferior or deformed lambs or lambs with poor breeding characteristics should be culled. Such characteristics as wool blindness (wool growing too close to the

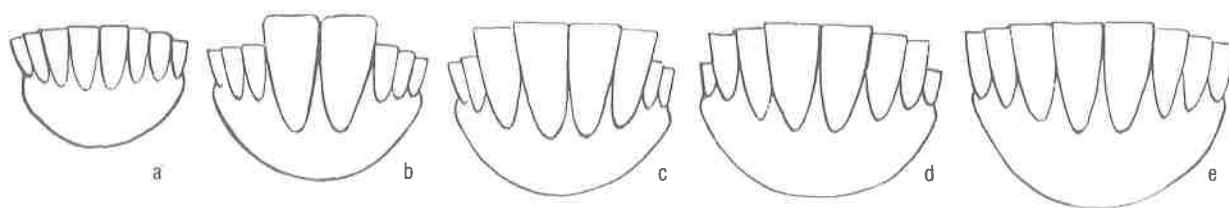

Fig. 2. Frontal views of the lower jaws of sheep of various ages. The upper jaw has no incisor teeth in the front. (a) all of the lamb's teeth are small. These temporary teeth are shed to make way for permanent teeth; (b) mouth characteristic of yearlings. The two large teeth in the center are permanent incisors which come in immediately following loss of temporary central pairs; (c) two pairs of permanent incisors, characteristic of 2 year olds; (d) mouth of 3 year old: three pairs of permanent incisors; note temporary teeth on each side are much smaller by contrast; (e) full mouth characteristic of a 4 year old.

At 5 or 6 years of age, these permanent teeth wear down and appear more slender with flatter grinding surfaces. At variable ages, depending on breed, teeth begin to spread and loosen through the "spreader," "broken mouth," and "gummer" stages. Sheep have no teeth at all at the gummer stage. Large growthy animals often replace temporary incisors with permanent incisors earlier than ages given above.



eyes), black wool fibers mixed with white wool, large amounts of kemp (white coarse fibers), crooked legs, and weak pastern joints should be culled from the flock. A small ewe does not produce as many pounds of lamb as a large one and should be culled if there is a large ewe available to replace her.

## Selection

Select thrifty and healthy ewes and rams to develop your flock. Ewes should be neither too thin nor too fat. Replacement ewe lambs that are too fat may not breed. Also, rams that are too fat may be poor breeders.

When establishing a small flock, select ewes of different ages. If they are all the same age, they will leave the flock at about the same time. There should be a relatively constant turnover of ewes to allow for a gradual genetic improvement in the flock.

**Older ewes.** A less expensive way to start a flock would be to buy older ewes rather than all young ones. Older ewes usually have more lambs than yearling ewes. Thus, a flock of high quality sheep can be assembled at less cost when some older ewes are included. Care must be taken in selecting. They should have good udders and be in good health. The condition of their teeth may not be a concern, for ewes fed in drylot or grazing good pasture do not need excellent teeth to be productive.

**Strong feet and legs.** Front legs should be set wide as viewed from the front. Feet should be sound. Toes should be short. Strong feet and legs are essential. There should be no sign of foot rot (severe foot rot can deform the foot) or weak pastern joints.

**Body.** The best shaped body should be long, heavily muscled, and have long legs. The back should be broad and straight, indicating muscling. A wide chest, deep heart girth and well sprung ribs are an indication of capacity to convert feed into pounds of lamb.

**Birth rate.** The number of lambs born (birth rate) is heritable. Select ewes and rams that were twins or triplets. Over many years, this kind of selection will result in a larger lamb crop.

**Wool quality.** Uniformity of wool fiber over the entire body, particularly in the shoulders, sides, and thighs, is important.

**Genetic defects.** Cull ewe lambs with genetic defects. Inverted eyelid, for example, is a heritable trait that should be culled. Jaw defects are found in all breeds (failure of front teeth on lower jaw to properly meet the dental pad on the upper jaw). Undershot jaw indicates that the teeth extend forward past the dental pad, and overshot indicates that the teeth hit in back of the dental pad. These conditions decrease growth of deformed lambs (fig. 3).



**Fig. 3.** Sheep with overshot jaws do not do well and should be culled from the breeding flock. The characteristic is hereditary.

**Rectal prolapse.** The rectum protrudes several inches past the anus in rectal prolapse. This condition is common among meat breeds and lambs on high concentrate rations. Affected animals usually are slaughtered before they are ready for market, with great economic loss. Sheep with this trait should be culled.

**Cryptorchidism.** This condition, where one or both testicles of a ram are retained in the body cavity rather than descending into the scrotum, is heritable. It has been associated with the polled characteristics in Merinos and Rambouillets. Growth rate is unaffected, and this trait is of little concern to the commercial sheep producer. However, registered producers should have this trait eliminated from their flocks.

**Skin folds.** Sheep with Rambouillet and Merino blood are the most likely breeds to have folds of skin on the neck. Sheep with heavy folds are hard to shear, and do not produce more wool. Excess skin folds can be eliminated by selection.

**Wool blind.** Wool covering on the face is heritable and is related to other traits. This problem is most common in wool breeds, but is found in some of the meat breeds, and some crossbred sheep. Experience and research have shown that open face ewes raise more lambs and wean more pounds of lamb than ewes with extremely woolly faces (wool blind). Also, wool blind sheep tend to get foreign material in their eyes that could cause permanent blindness (fig. 4).

**Breed standards.** Producers of purebred sheep should select sheep that meet minimum breed characteristics. Ewe lambs that do not meet these standards should be sold for meat or as commercial ewes. Furthermore, only outstanding male lambs should be saved for rams. Because of the small number of animals with which they are working, it is more difficult for small producers to make rapid improvement in their flocks through ewe selection. However, they can buy superior rams or ewes to improve their flocks.



Fig. 4. Open-faced ewes (*right*) produce more lambs and pounds-of-lamb per ewe per year than ewes with closed faces (*left*). This is true even when wool-blend ewes have had their faces shorn periodically throughout the year.

## REPRODUCTION

Reproduction is the most important part of raising sheep. In order to develop an effective breeding program, a person must understand breeding season, estrus cycles, gestation, puberty, and fertility.

### Breeding Season

Most sheep are seasonally polyestrous (seasonal breeders). However, the length of the breeding season is influenced by the breed of sheep. Rambouillet, Merino, and Dorset have long breeding seasons, and many individuals among these breeds will breed at any time of the year. Breeding may start in April and continue into late fall. Romney and Leicester (long wool breeds), as well as Southdown, Cheviot, and Shropshire, have a short breeding season: August through January. By comparison, Suffolk, Hampshire, Columbia, and Corriedale have a longer season: July through January.

### Estrus or Heat Cycle

Estrus, or the heat period, is defined as when the female is sexually receptive to the male and can conceive. The length of the estrus cycle (days between heat periods) is 14 to 19 days, with an average of 16 1/2 days. The length of the heat period is 20 to 42 hours; the average is 30 to 35 hours. Ovulation (release of the egg from the ovary) usually occurs toward the end of the heat period. The ovulation rate (number of eggs released per heat period) changes during the breeding season. It is low during the first part of the breeding season, high in the middle, and decreases to low at the end of the season.

### Gestation

Gestation is 144 to 152 days; the average is 147 days. Meat breeds tend to have shorter gestations, and fine wool breeds have slightly longer gestations. High temperatures can shorten gestation by 2 to 3 days. Also, multiple births may shorten gestation by a few days.

### Puberty

A ewe reaches puberty (starts her heat cycle) at 5 to 12 months. Heredity and nutrition strongly influence age at which the animal reaches puberty. Most ewe lambs weigh 85 to 100 pounds before they start to cycle. Fine wool and Finnish Landrace (Finn) breeds start to cycle at lighter weights, while the larger meat breeds reach puberty at heavier weights.

Ewes that reach puberty at a younger age have a greater lifetime production. Ewe lambs born early in the season will reach puberty at an early age.

### Fertility

Fertility in the ewe can be influenced by:

1. Heredity
2. Age of ewe
3. Light, temperature, humidity, and season of year
4. Association with the ram
5. Nutrition
6. Disease and parasites

Because so many factors influence fertility, progress in increasing fertility in a ewe flock through genetic selection is slow. Culling open ewes is the fastest way to increase flock fertility.

**Heredity.** This can influence fertility and fertility rate (number of lambs per lambing). Highly fertile ewes that reach puberty at an early age usually produce lambs that are highly fertile and reach puberty at an early age. Replacement ewe lambs and ram lambs should be selected from twin or triplet births. Over many years, this type of selection will increase a flock's fertility rate. Also, certain breeds naturally produce more lambs; Finnish Landrace is known to have many lambs (as many as three to seven live ones per lambing). Under good management 85 to 95 percent of ewes with one-fourth Finnish Landrace blood will produce twins.

**Age of ewe.** An average pregnancy rate in ewe lambs is about 65 percent in most farm flocks. However, with good management and nutrition, this rate can increase to 70 or 80 percent. Ewes that lamb as yearlings usually do not give birth to more than one lamb. As ewes reach 8 or more years of age, fewer of them become pregnant, but those that do usually produce more lambs.

**Light, temperature, and humidity.** These elements influence when a ewe starts her seasonal cycle. While they cannot be changed, understanding how the cycle works may help increase the number of lambs born. Because of individual and breed differences, breeding activity can occur in all months of the year in sheep. However, fertility is highest in the black face breeds (Hampshire or Suffolk) in September, October, and November when light exposure is 10 to 12 hours per day. The cooler temperatures then will increase embryo survival. Ovulation rate is closely related to the amount of light in a day as well as to temperature. High temperatures (90°F or higher) and high humidity can reduce fertility. Hot weather also will influence the growth rate of the fetus. Heat stress during gestation will result in smaller lambs at birth. Shade should be provided when possible.

**Association with the ram.** Putting a ram with a group of ewes will help start their estrus cycle earlier in the season. Producers wanting early lambs should turn a vasectomied ram (a ram that cannot ejaculate sperm cells) in with ewes 2 or 3 weeks before the breeding season to start ewe cycling earlier. This practice will ensure that more ewes will be in the second or third heat period when they are bred. Also, this practice will tend to bunch the ewes in estrus, more ewes will be in heat at one time and the lambing period will be shortened. This practice could make it possible to reduce the length of the breeding season. Ewes exposed year around to the ram may breed later in the season.

**Nutrition.** Nutrition, more than any other factor, influences fertility and fertility rate. Ewes that are too thin will not cycle normally, and if they do, they will not conceive at a normal rate. The same is true of ewes that are too fat. Fat ewes usually are more of a problem for small flock producers. There is a temptation to become attached to the sheep and to overfeed them. To lose weight or maintain weight, the ewe has to be hungry for a short time each day. It is better to have her a little hungry than have her too fat.

**Flushing.** Flushing is a nutritional practice that can increase fertility of ewes and the number of lambs born. This practice involves increasing the level of nutrition of the ewe 2 to 3 weeks before and during the breeding season. This increase includes an increase in energy as well as in protein. Most authorities believe flushing increases the number of eggs released during ovulation. Flushing thin ewes tends to cause them to start cycling sooner and may increase the number of lambs born.

Ewes grazing on poor quality pasture from weaning to flushing time may be flushed by placing them on high quality pasture. Ewes should not graze pure clover pastures at breeding time because many clovers contain an estrogen that can interfere with the normal heat cycle.

Another flushing practice: supplement ewes on poor quality pasture with 1 pound of a high quality alfalfa hay. This should provide enough additional energy and protein to ensure good breeding performance. Do not flush ewes with more than 4 pounds of alfalfa hay daily.

Ewes grazing poor pastures should receive 1/2 to 1 pound of a grain supplement that contains at least 60 percent total digestible nutrients (TDN) and 10 percent crude protein. Do not feed the full amount on the first day—start with 1/4 pound per day and increase the feed gradually. The increase should be about 1/4 pound per ewe per day. With this practice allow enough feeder space so that all the ewes will be able to get their share of the supplement; otherwise, dominant ewes will get too much feed and less aggressive ones will not get enough.

**Diseases and parasites.** Diseases and parasites can reduce fertility of the ewe as well as of the ram. If a ewe becomes sick she may not start cycling at the proper time, or if she has been cycling, she may stop. A heavy parasite population in sheep will reduce condition and general health. If parasites are suspected, ewes should be wormed before breeding.

# BREEDING

An effective breeding program begins before the season starts and continues to the lambing date. The ewe must be in good health before breeding. She must be bred at the right time and the ram must be fertile in order to produce a good lamb crop.

## Preparing the Ewe

At least 1 month before breeding, the ewe should be given all the injections necessary to prevent abortion and any other treatments needed for a good health program in your area. Consult your local veterinarian. Occasionally, injections may make the ewe sick for a few days and may interrupt her heat cycle. Also, it will take a short time before the vaccine will provide protection or immunity.

**Worming.** Worm ewes before breeding for reasons discussed in the section on internal parasites.

**Keeping ewes cool.** In hot climate, shear ewes 4 to 5 weeks before the breeding season to help them start cycling early. Shearing will make the ewe cooler and will reduce heat stress; however, shearing the ewe immediately before breeding season can cause heat stress because the wool insulates the ewe against direct sunlight. About 1/2 inch of wool will insulate sheep from direct sunlight and will still allow body heat to escape. Heat stressed ewes have a high incidence of embryo death. Short wool on the ewe, in combination with shade, can help reduce heat stress.

**Weight gain.** Ewes should gain weight before breeding. A 10-pound gain per month per ewe is adequate to ensure a good flush. Ewe lambs to be bred should gain at a faster rate than mature ewes, and should weigh 100 or more pounds.

**Overeating disease (enterotoxemia).** A flock with a history of enterotoxemia (overeating disease) should be vaccinated about 3 to 4 weeks before lambing. This management practice will protect the lamb until it is old enough to be vaccinated. Enterotoxemia also may be called pulpy kidney. (For more information see section on diseases.)

**Tagging.** Ewes that have manure or urine-stained wool around their vulvas should be tagged before breeding. This practice will improve breeding efficiency. Also, 4 to 6 weeks before lambing the ewes should be tagged or shorn. Tagging is shearing or clipping the wool from the ewe's flanks, udder and vulva area so that the signs of lambing can be more easily observed. A bare vulva is more sanitary during lambing. Bare flanks and udder make it easier for the lamb to find the nipple, and the person taking care of the ewes can observe more easily whether the lamb is nursing.

Many large sheep operators in the Northwest who lamb in sheds shear ewes 3 to 4 weeks before lambing (lambing out of the wool) with a "rake" comb that leaves 1/4 to 3/8 inch of

wool. Fall shearing also is becoming more common in parts of California. In cold or wet climates the ewe should be protected from the weather for several days following shearing. Lambing out of the wool keeps the lambing shed cleaner and drier for the ewes and does not bring as much dirt and moisture inside. Also, the shorn ewe does not take up as much space in the shed and at the feeders. Another advantage to shearing before lambing for new producers with a few sheep is that they can watch the ewe's development in the later stages of pregnancy.

## Preparing the Ram

**Condition.** Rams in good condition have the energy to breed ewes. Overconditioned rams usually are more sensitive to high temperature and their sexual activity is reduced.

**Cooling.** In hot weather shear rams before breeding. Again, they should have about 1/2 inch of wool. In hot weather, remove ram(s) from ewes during the day and place in a shaded or cool area and turn back with the ewes at night. If they are not heat stressed, they will be more sexually aggressive, thus increasing the chances of more lambs being born in the first part of the lambing season. Rams can be sterile for 6 weeks following exposure to high temperatures or from a fever.

**Soundness.** Rams must be physically sound. Feet should be checked for foot rot and excess hoof. Long hooves should be trimmed several weeks before the start of breeding so that the ram will recover from any lameness that may occur as the result of a too close trimming. A lame ram cannot breed.

The rams should be checked for sores on the penis sheath, and any infection observed should be healed before breeding. The scrotum of the ram should be checked for abnormal growth or misshapen testicles. Also, when possible, rams should be semen tested by a veterinarian. A sterile ram cannot produce lambs, and a ram with low fertility will produce few lambs and will extend the lambing season. Semen testing is especially important where only one or two rams are used. If one or both are infertile, the lamb crop will be severely reduced. If a single ram is used and it is sterile, no lambs will be born.

One sexually active ram can serve 30 to 50 ewes. In confinement or close breeding conditions, one ram can breed a much larger number of ewes.

A well developed ram lamb (6 to 10 months old) can serve 20 to 25 ewes. The breeding activity of a young ram should be observed closely. An inexperienced ram may devote too much attention to one ewe and ignore other ewes in estrus. If this occurs, the ewe should be taken away from the ram after she has been bred once or twice.

## Recording Breeding Dates

Breeding dates are important in order to determine when the lambing season will begin. To assure accurate breeding dates, equip the ram with a marking device. Commercial marking harnesses are available that work well. Another marking system that works well involves a mixture of plain white grease, or 10-40 weight motor oil, and cement dye or lamp black placed on the ram's brisket at least every third day. As the ram mounts a ewe, he will leave a colored mark on her rump. The marks can be recorded daily. The record can be used to estimate the beginning date of the lambing

season, and the time to have necessary equipment ready when the first lambs arrive. To check for repeat breeding, start with a light color dye and each 14 days use a darker color.

Ewes that conceive will not come back into heat. During breeding season check the flock at least once daily to make sure the ram is healthy and not lame. When possible, have a back-up ram available in case the working ram becomes sick or lame. High fever for a relatively short time can cause temporary sterility in rams.

# LAMBING

---

Lambing time is probably the most satisfying part of sheep raising. A good lamb crop is a measure of the success of your breeding program, and how well you have taken care of the ewes and lambs.

## Preparing Lambing Shed

The lambing shed or area should be clean and disinfected several weeks before the first lamb arrives. Remove old bedding and allow the area to become completely dry. A layer of "slake" lime (usually available at building material yards) on the ground will help sanitize the soil. In lambing sheds with a history of disease, disinfect walls and feeders with a strong disinfectant. A good layer of clean bedding—cereal or grass straw—should be applied to the entire shed. Wood shavings may also be used for bedding, however, sawdust used as bedding may cause problems; small slivers of wood may work into the gland opening between the toes as well as the soft tissue of the foot, causing abscessed feet.

## Protection for Newborn

During lambing in cooler climates, ewes and lambs should be protected with a shelter that is dry and free of draft at ground level. A newborn lamb comes from a 101°F environment in its mother's uterus and is wet; therefore, it is very susceptible to chill. Also, the lamb's body mass is small, which allows the entire body to become quickly chilled. Wind, rain, and cold temperatures can cause rapid deaths. Baby lambs need protection until they are dry, warm, and have received colostrum.

The protected area (lambing shed) should have adequate ventilation to remove the excess moisture and ammonia that is created when the ewes are confined. Also, if the ewes are not shorn and are confined in a poorly ventilated area, they can become heat stressed. This heat stress could trigger pregnancy disease (see disease section).

## Lambing Jugs or Jails

As soon after lambing as possible a ewe and her lamb should be placed in a small pen, called a jug or jail, that is at least 5 feet wide by 5 feet long. Also, as a good rule of thumb, there should be one jug for every 10 ewes. For small flocks one or two jugs should be adequate. The smaller the jug, the greater the chance that the ewe will lie on her lamb and crush it. To protect the lamb, when small jugs are used, place a railing about 6 inches above the bedding. This will help prevent the ewe from lying on her lambs.

Each jug should be equipped with a hay feeder, grain trough, and water. Ideally, all feeding and watering equipment should be portable so that it can be removed from the jug. Also, waterer and feeder should be high enough off the ground so that a lamb cannot become trapped in them. Low, shallow water buckets are very dangerous for new lambs. They are not very stable on their feet and can fall in the water and drown.

## Checking Ewes at Lambing

The ewe flock should be checked several times a day for 2 weeks before the estimated start of lambing, as well as during the season. Ewes carrying two or more lambs usually deliver several days early, so it is better to be prepared rather than to suffer a surprise.

## Signs of Lambing

Several signs will indicate how close the ewe is to lambing. Two to 4 weeks before lambing, the ewe's udder should begin to fill, and in some cases the skin may be very red. The vulva will give a soft, shiny appearance and will be enlarged. Many ewes will make grunting sounds as they move around or while they are lying down.

Most ewes will have a mucous discharge from the vulva during the 24 hours before lambing and usually will stop eating several hours before delivery. Ewes that do not eat should be watched closely. They are either getting ready to lamb or they may be coming down with pregnancy disease. As delivery nears, the ewe usually will lie down and get up often. She will walk around in a small area. Ewes lambing for the first time usually will lie down, strain once or twice, and get up to see if the lamb is there. She has not learned that it takes more effort.

A sure sign that the birth process has begun is the appearance of the water sac. Once it has appeared, let the ewe work at having the lamb by herself—do not try to help her at this

time. In most cases she does not need help. If a ewe has the lamb by herself, it will strengthen the ewe-lamb bond.

The next sign should be the lamb's two front feet. If the tops of the feet are showing, the lamb is coming properly if everything is lined up. If the bottoms of the feet are showing, the lamb is coming breach, or backward. The nose appears after the feet. Pushing the head out is usually one of the most difficult parts of the delivery. After the head is completely exposed, the shoulders appear next and once the shoulders appear, the rest of the lamb is born very easily.

The following pictures show the birthing process (fig. 5).

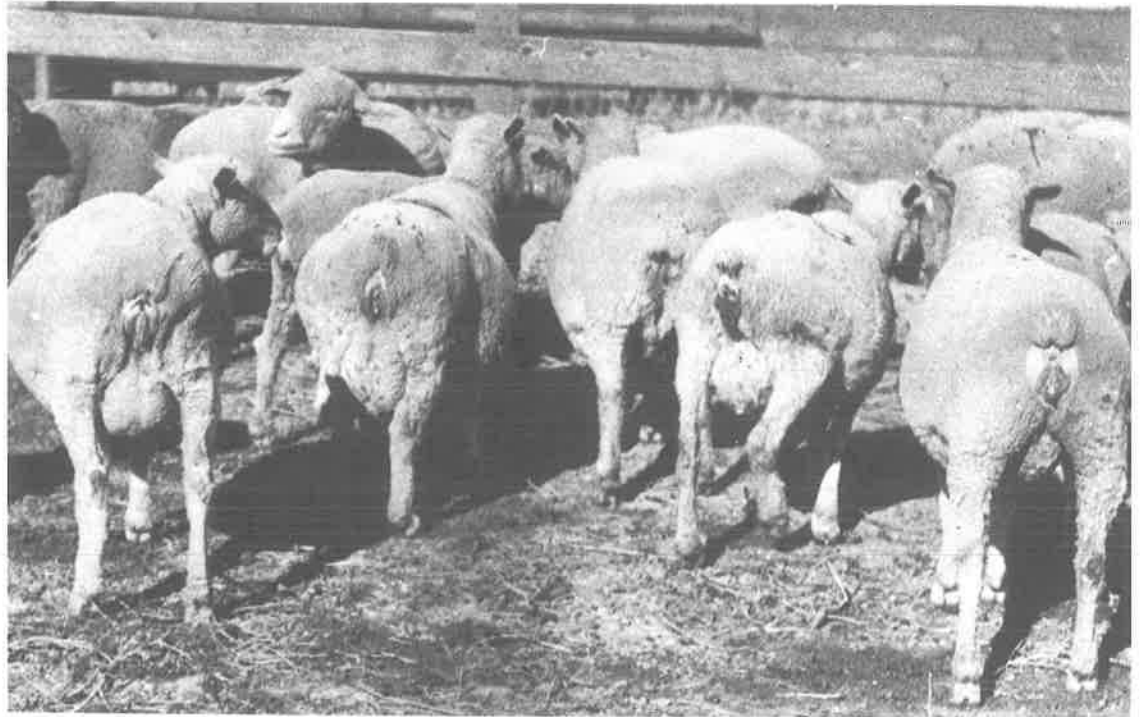

Ewes in late pregnancy (*above*) showing enlarged abdomen and filled udder. They are sedate in their actions and should be handled gently.

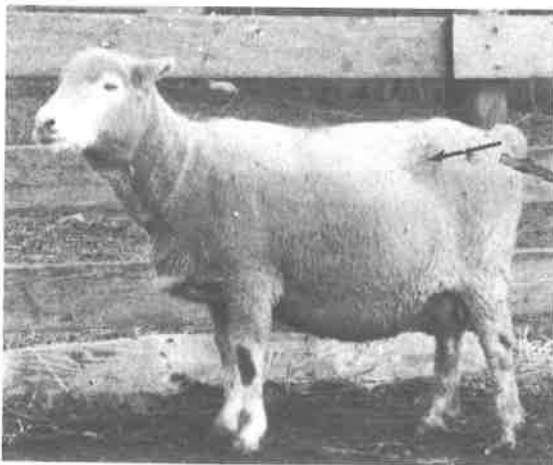

As the time of birth approaches, the ewe develops a hollow, high in her flank (see arrow).

Fig. 5. The birth of a lamb.



The embryonic sack, or water sack, appears first when the birthing process has begun.



The front feet appear shortly after the water sack is presented. The picture shows one foot; the other will appear shortly. Note that the top of the hoof is showing, indicating that the lamb is coming front feet first.



The birthing process has progressed to where the head and front legs appear. Note that the embryonic sack has not broken yet. Once the head is out, the rest of the delivery is usually fast and easy.



The lamb is delivered to its hips. The birth is about completed. Note that the embryonic sack has not broken yet.



The ewe is cleaning the embryonic sack from the lamb's head. She will lick the lamb to stimulate it. At this point the lamb may look dead but the ewe's licking stimulates the lamb.



The lamb is responding to the ewe's licking. Its head is up.



Alert and ready, the lamb is trying to get to its feet.



The mother continues cleaning and stimulating the lamb after it gets to its feet.





The lamb is looking for the ewe's udder and something to eat.



One lamb is exhibiting a very strong response in looking for the ewe's udder; its twin is looking on. Check twin lambs to be sure both receive colostrum.



The lamb has found the ewe's udder. It will wriggle its tail. Make sure the lamb gets hold of the nipple and nurses.



This ewe has not shed her afterbirth. A ewe can shed her after-birth during birth or up to several hours later without health problems.

## Helping the Ewe

Once the water bag has appeared, the birth process should be completed within an hour. If it is not, the ewe will need assistance. An inexperienced person should not assist a difficult delivery alone; get experienced help if possible—a local veterinarian or an experienced sheep producer. However, if no one is available, the following discussion may help:

First, wash your hands and arms with soap and water. Cover your hands and the ewe's vulva with liquid soap—a disinfectant soap is best. If the water sac has broken and the lamb is dry, apply liberal amounts of soap to the lamb and ewe. The soap acts as a good lubricant helpful in delivery. Soap flakes applied to the moistened hand and arm will last longer as a lubricator than will liquid soap. Mineral oil also can be used, but it is less sanitary than soap. Fingernails should be closely trimmed to avoid damaging membranes in the birth canal.

Before attempting to help the ewe, you should recognize how the lamb is being presented. Figure 6 shows several abnormal ways in which lambs can be presented.

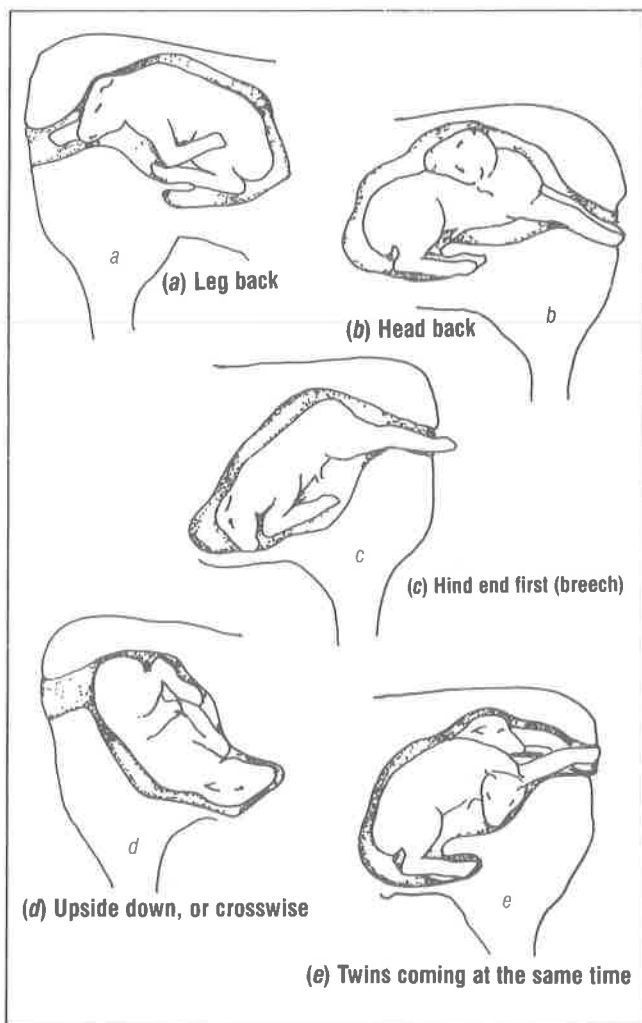

Fig. 6. Abnormal lamb presentations at birth.

A lamb with a large head is a common problem in lambing. To help the ewe trying to deliver a lamb with a big head, lay her on her side and grasp the front legs of the lamb with one hand, sliding the fingers of the other hand up over the forehead of the lamb. Next, pull the lamb with both hands slightly down (toward the ewe's feet) and out. Continue to pull firmly and slowly until the lamb is completely delivered. Delivering the lamb with too much force or too quickly could cause the ewe to prolapse (the uterus turns inside out). This condition may occur following a difficult delivery.

A device useful in helping ewes deliver, called a lamb saver, is available commercially (fig. 7). It is made of a hollow tube with a looped cable attached. The loop is passed behind the lamb's head and the tube under the lamb's chin. The cable and tube are pulled to help move the head as the feet are being pulled.

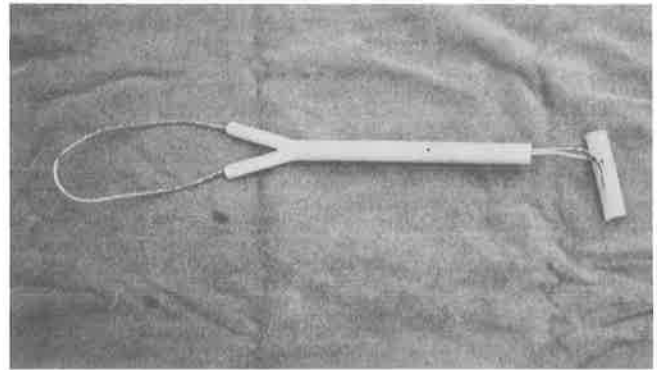

Fig. 7. Lamb saver. This tool is often useful in delivering lambs.

Another common type of delivery occurs when the head and one front foot are presented or are in view. The other leg is inside the ewe. In most cases it is not necessary to get the other front leg out before attempting delivery. The lamb can be delivered by pulling on the head and the leg that is showing. In extreme cases the lamb's head must be pushed back far enough to insert a hand in and pick up the leg that is back. Pushing the lamb back may be difficult for the ewe is trying to push the lamb out. To stop the ewe from pushing, ask an assistant to open the ewe's mouth and pull her tongue forward. Pulling on the ewe's tongue should stop the birth contractions. When both legs are out, the lamb can be delivered normally.

Sometimes only the head is showing and both front legs are inside the ewe. The head must be pushed back far enough to insert a hand and pick up the legs with an index finger. In this case, a person with a small hand is very useful. Once one or both legs are forward, the lamb can be delivered.

The lamb's head can swell and be very large, if the ewe has been trying to lamb for some time and the head has been exposed. At this point, check to see if the lamb is alive by inserting a finger into the lamb's mouth—if there is a sucking reflex, the lamb is still alive. The lamb's head may be so large that it is difficult to push the lamb back far enough to get a

hand in the ewe; however, if pressure is slowly applied to the head and it is pushed back into the ewe between contractions, normal delivery can be accomplished. If the lamb cannot be delivered at this time, it will die, and if that happens, the head must be cut off and the lamb's body removed to save the ewe's life.

Another situation that may occur is when there are three feet and one head showing from the ewe, indicating the presence of two lambs. To correct this situation, a person should line up the lambs and make one wait its turn by inserting a hand and finding out which leg belongs to which lamb. Push back the leg that doesn't belong to the lamb with its head showing. Once the "extra" leg is out of the way, the first lamb can be delivered. The second lamb can be delivered by finding the front legs and pulling them out.

If a ewe has shown signs of lambing for 1 or 2 hours and the lamb has not appeared, check to see whether the lamb is entering the birth canal properly. First, lay the ewe on her side and insert a hand to see if the mouth of the uterus is enlarged (dilated) enough for delivery. If the uterus is not dilated enough so that you can feel the lamb, give the ewe another hour. When the uterus is dilated enough, make sure the lamb is lying properly for a normal delivery and give her about 30 minutes. If delivery has not progressed, the ewe will need help.

If the ewe has had difficulty giving birth, you may wish to insert a hand into the uterus after a lamb has been delivered to check for additional lambs. Triplets or even quadruplets are not uncommon. The size of a lamb does not indicate how many lambs a ewe may have. Sometimes a ewe may have one large lamb and one small lamb. If the large lamb is delivered first, a person could think that is all the ewe has and will stop checking her. The second lamb may not be lying properly for a normal delivery, and both the ewe and lamb could be lost because of lambing difficulty.

## Care of Ewe and Lamb after Birth

**Clearing airways.** After helping a ewe deliver, clear the lamb's airways. Hold it by its hind legs and allow the birth fluids to drain from the air passages, while placing a finger in the mouth to help remove mucous. Sometimes this may not completely clear the airways and the lamb still may have trouble breathing. The lamb can be swung around in a circle by holding its hind legs. The faster a person turns, the better the airways will clear, but be careful. This technique requires a lot of space. In small areas the lamb's head could be bumped on a solid object, resulting in death or serious injury.

Some new lambs need encouragement to breathe. It is most important that the lamb takes that first gasp of air. One way to get it to breathe is to take a small straw or stem of hay and push it gently into its nose. Usually, it will sneeze and take a breath of air. If this does not work, give the lamb artificial respiration by raising a front leg—this helps expand the chest cavity and draws air into the lungs. Push the leg down and

repeat until the lamb starts to breathe. Mouth-to-nose resuscitation works well, but some people do not like placing their mouth on a lamb's nose. The lungs of the lamb can be filled with air by blowing hard into the lamb's nose.

**Stillbirth.** Occasionally a lamb may die in the uterus, and the ewe has not shown any signs of lambing. In this case, as the lamb starts to decompose, there may be a chocolate brown discharge. A veterinarian should be contacted so the ewe's life can be saved.

**Ewe's care of lamb.** Despite the lambing problems discussed, most ewes deliver lambs without assistance. The lambing season demands a lot of time, but a lot of personal satisfaction can be gained. The best policy at lambing: **BE THERE**—extra time with your ewes will mean saving extra lambs.

Once the ewe has delivered, she usually will get up and lick her new arrival. Licking removes the slime and afterbirth, as well as stimulates the lamb to get to its feet and nurse. Some ewes will do a poor job of cleaning their lambs. Others will do a good job—in fact, some ewes will get so carried away with the cleansing process that they will chew the lamb's tail and navel cord. If this occurs, remove tail, clip navel cord, and treat with iodine immediately, thus reducing the chances of infection, loss of blood, and other trauma to the lamb.

If possible, do not disturb the ewe while she is delivering and cleaning her lambs. This includes freedom from interference by other ewes. If she is disturbed, she may leave her lambs; also, if she has twins, she may accept one lamb and reject the other. She needs time to get to know and recognize her lambs.

A ewe that has had a hard, long delivery may be too tired to get up and clean her lamb. In this case, clean the afterbirth off the lamb's nose and mouth so it won't suffocate and present the lamb to the ewe. Avoid excessive handling, however.

Another problem that can occur is that an older ewe may granny another ewe. Figure 8 illustrates how a granny ewe acts. The granny ewe, usually very near to lambing herself, may see another giving birth. When the lamb arrives the granny will try to take the lamb away from its mother. This is a particular problem with multiple births in young ewes. A young ewe may have the first twin, which she will clean, and then while she is lying down to have the second, the granny ewe will claim the first lamb. When the new mother gets through delivering, she will think she has had only one lamb. The granny ewe will have no milk, but she will encourage "her" lamb to nurse, and if the problem is not straightened out, the lamb will starve to death.

To prevent this problem, keep granny ewes separated from those that are lambing. Also, if two ewes claim the same lamb, look for blood and birth fluid on the back side of the ewe. The clean ewe will be the granny.

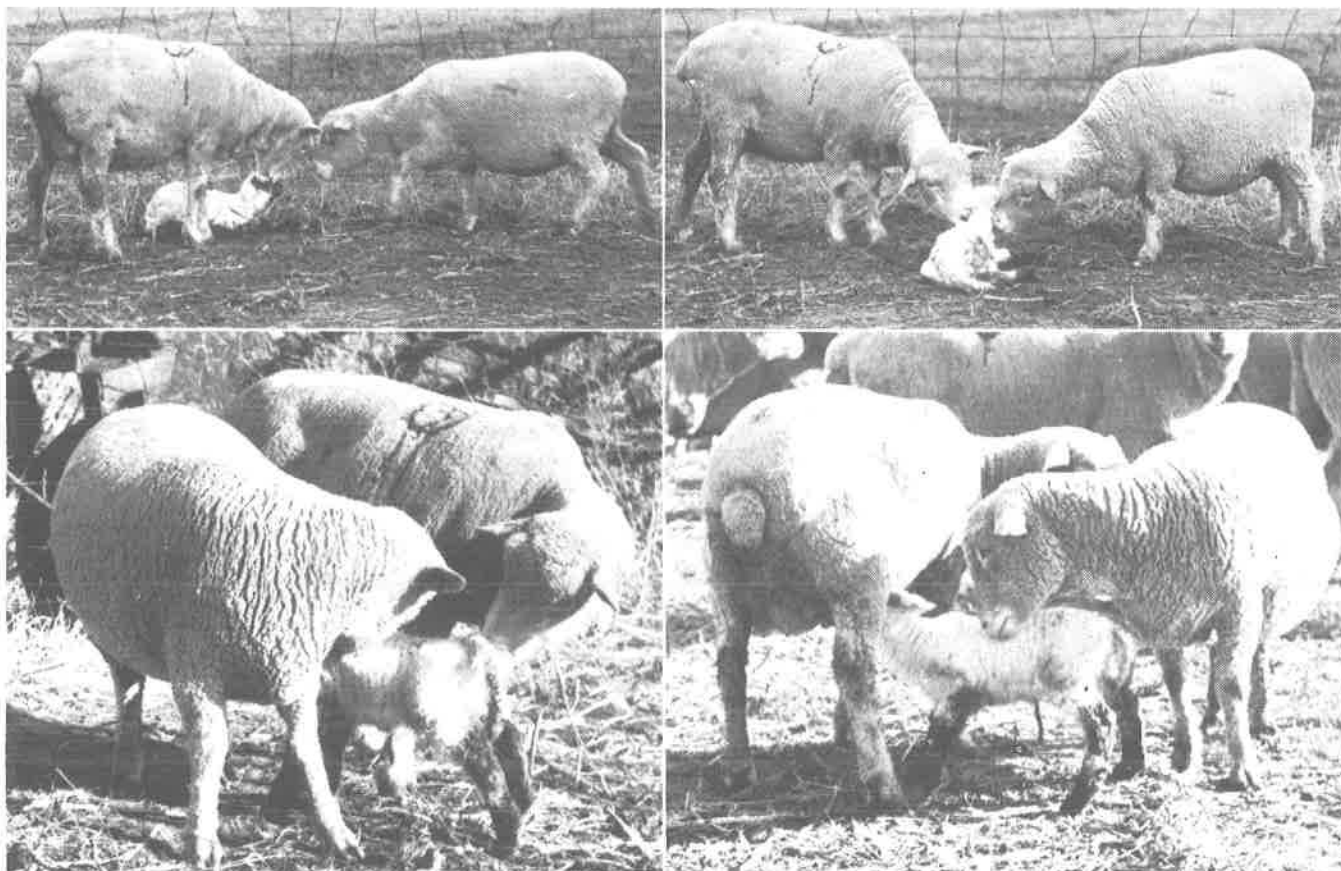

**Fig. 8. Difficulties with "grannies."**

**Top left:** The ewe (*left*) has just given birth to the lamb. A "granny" (*right*), though not due to lamb for some time, has her mothering instinct aroused and would like to claim the lamb.

**Top right:** First, granny helps mother clean the newborn.

**Bottom left:** Next, the granny (*left*) enjoys having the lamb try to nurse her although she has no milk.

**Bottom right:** Finally, the mother (*left*) is successful in warding off the granny long enough to allow her lamb to start nursing her own full udder. In some instances, particularly with young, inexperienced mothers, grannies are able to steal lambs which ultimately die of starvation.

Once the ewe has lambed, remove her to a jug, by getting her to follow her lamb or lambs into a pen rather than driving her there. Pick up the lamb by the front legs with the hind legs almost touching the ground. Hold it until the ewe sees it and if she comes up, let her smell it. Walk slowly toward the pen, making sure the ewe sees the lamb at all times. If the ewe moves away, stand still and make the sounds of a lamb to get her attention—she will usually come back to the lamb. If she does not, set the lamb on the ground, step back and let the ewe come up to her lamb. This process may need to be repeated several times before the ewe reaches the pen with her young. The ewe will not get as upset as if she were driven. She will be more quiet.

**Check list for ewe at lambing.** Once the ewe and her young are in the jug, follow this checklist:

(1) Check the ewe's udder for hard lumps that will indicate earlier udder damage—probably mastitis. These lumps will reduce her milk production. If the lumps are large and the ewe has twins, consideration should be given to removing one lamb to be raised as an orphan or "bummer." Another alternative; leave both lambs with their mother and give the lambs additional milk to supplement their mother's supply.

(2) Remove the waxy plug in the end of each teat of the ewe by stripping a couple of squirts of milk from each teat. Small or weak lambs cannot remove this plug and may starve even though they are nursing. The ewe's udder can become so enlarged and so sore that she will not permit nursing. Also, this situation can spoil the ewe's udder to the point that she cannot raise any future lambs. A spoiled or mastitic udder condition may be called "blue bag."

Many producers take a sample of the ewe's milk and test it for mastitis, but this is not a necessary step in caring for lambs. Mastitis testing kits that dairy producers use are available. A ewe with mastitis can be treated with a broad spectrum antibiotics. Consult your local veterinarian. Some ewes produce a thick yellow milk which is okay for the lamb to drink. Other ewes will have more normal, less thick, milk which is okay, too.

(3) Trim the lamb's navel cord to about 1 inch in length and treat with a 7 percent solution of iodine. This step should be completed as soon after birth as possible. Re-treat again in an hour, if possible. Treating a navel cord that is already dried is not effective. The navel cord is cut at about 1 inch so that the iodine can be more effective. The lamb or ewe can-

not step on the short navel cord. Stepping on a long navel cord could pull it off, which may cause severe bleeding. Cutting the navel cord too short also can cause excessive bleeding.

The lamb's navel can be treated very easily. Put 1/2 to 1 inch of the iodine solution in a widemouthed glass jar. Pick up the lamb by the front legs and place the jar over the navel area. Tip the jar up so the navel is saturated with the iodine solution. This process is more effective than swabbing the navel.

The navel is treated with iodine to prevent bacteria from entering the navel cord and moving into the body. When bacteria invade the body, the infection usually settles in the joints, causing lameness. This condition is called navel ill or navel ills. The infection is difficult to cure because the joints receive a low blood supply. Curing a lamb that has navel ill is very expensive, and success is doubtful. The sick lamb may live, but it will grow poorly.

(4) Make sure the lamb can nurse. Within a few hours after birth a lamb must get colostrum or "first milk." This milk contains a wide range of antibodies that will help protect the lamb against disease. Colostrum milk, also high in protein and fat, acts as a laxative which helps the lamb's digestive system rid itself of the fetal plug. A newborn lamb can absorb antibodies very well, but the ability to absorb antibodies declines rapidly. Absorption is reduced by one-half at 12 hours of age and is near zero at 24 hours, so the sooner the lamb gets colostrum after birth, the better. *Colostrum is important!*

The best source of colostrum is from the ewe, but if ewe colostrum is not available, cow or goat colostrum can be substituted. Some producers rob colostrum from ewes and store it. Colostrum can be frozen and stored for future use. Freezing in ice cube trays allows use of part of the colostrum at a time. One or two cubes of colostrum should be enough for a feeding. Once frozen, cubes should be transferred to an airtight plastic bag or container for storage. Thaw frozen colostrum at room temperature. High temperatures may destroy the antibodies.

**Make sure lamb nurses.** Get the lamb up and introduce it to its new "snack bar," the mother's udder. The lamb usually will wiggle its tail when it is nursing, but some lambs will wiggle their tails when their heads are next to the mother's udder. Make sure the lamb has found the mother's teat and has nursed.

Some ewes will not stand still while you are trying to get the lamb to nurse. To overcome this problem, set the uncooperative ewe on her tail, stand behind her and hold her head up next to your chest. With the ewe in this position, lay the lamb between her hind legs and put the teat in the lamb's mouth. In this position you can force milk into the lamb's mouth. Once the lamb tastes milk, it should start nursing. Let the lamb nurse until it is full. It will be hard to tell if the lamb has

gotten any milk. Baby lambs nurse very often and do not take much milk at one time. With experience you will be able to tell if the lamb has received milk by how tight its stomach feels. Another way to tell if the lamb has nursed is to shake it gently while listening for the milk to splash in its stomach.

When trying to get an uncooperative lamb to nurse its mother (when the mother will stand), push the lamb into the nursing position and hold it there with your knee. Then open the lamb's mouth, put the teat in its mouth and hold the lamb until it nurses by itself. Do not put your hand on the back of the lamb's head. It will pull back and fight to get away as long as there is pressure there.

**Nursing weak lambs.** Sometimes a lamb may be too weak to nurse. Do not give up; in most cases it can be saved by feeding it with an esophageal probe (fig. 9). A small (1/4 inch or less in diameter) soft tube also can be used to pass down the lamb's esophagus into its stomach; once the tube is in place, the lamb should be given 1 to 2 ounces of colostrum. The problem with this technique is that the tube may be placed in the lamb's lungs and if milk is forced into them, the lamb will die. When passing the tube down the lamb, be gentle and work slowly. Tip the lamb's head back so that the mouth is in a straight line with the esophagus. Place one hand on the lamb's throat and pass the tube. You should be able to feel the tube pass down the esophagus. If the tube stops, do not force it or you may puncture the esophagus or lungs. The lamb should respond to feeding within 30 minutes to 1 hour. When the lamb gets to its feet, take it back to its mother. Watch the lamb closely for the next few days to make sure it is nursing.

If a small tube is not available, the lamb can be fed with a bottle and small lamb nipple. Tip up the lamb's head and force a few drops of colostrum milk into its mouth. Then rub its throat gently to stimulate swallowing. Continue until the lamb has consumed at least 1 ounce of milk. This process is slow and requires patience. Again, care must be taken to avoid getting milk into the lamb's lungs.

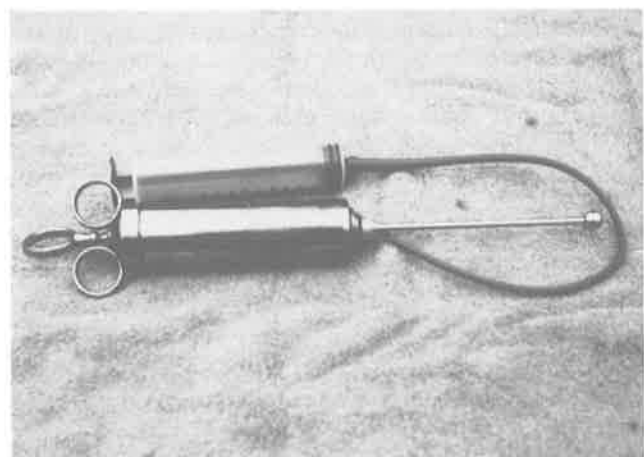

Fig. 9. Two types of esophageal probes used to force feed weak lambs.

**Identify lambs.** Soon after birth identify each lamb with a permanent ear tag or ear tattoo. Identification is important for matching ewes and lambs, and it is a must if flock production records are to be kept. Tagging the right ear of males and the left ear of females will help when separating lambs in a corral. Plastic tags, although slightly more expensive, reduce the possibility of ear infections and tag loss.

In larger flocks ewes and lambs are paint branded on the backs and sides with the same number. This will help keep track of ewe-lamb pairs to see how well a ewe is feeding her lamb(s) during the first weeks after birth. Ewes and their twin lambs can be branded on the right side, and ewes and single lambs can be branded on the left side. This system will help identify those ewes that are not raising their twins properly. If you see a lamb with a number on its right side that is doing poorly, find its mate to see whether it is doing well. If one twin is doing all right and the other is not, consider caring for the poorly doing lamb as a bummer.

## Grafting

In grafting, a ewe that has lost her lamb is convinced to adopt an orphan or "bummer" lamb. Grafted lambs can come from ewes that have died, ewes that have had triplets or quadruplets or ewes with twins that are able to raise only one lamb. There are several ways to graft lambs, and the following is a discussion of some of the more successful procedures.

**Slime graft.** The easiest graft is a slime graft which can be carried out only shortly after a ewe has lambed. This is done if a ewe has given birth to a dead lamb. (Before grafting, remove the dead lamb from the pen.) The "bummer" lamb (the lamb to be grafted) is then covered with or rubbed in the slime or birth fluid. The fluid will give the bummer the scent of the ewe's own lamb. This type of graft must be done before the ewe has realized that her own lamb is dead. Also, this type of graft works best with younger bummer lambs. An older, aggressive bummer lamb may overwhelm the ewe and she will reject it, even though it smells like her lamb.

A double graft is possible if the ewe has enough milk. Both lambs must be covered with the birth fluid and both should be about the same size. If one lamb is too large it may take most of the milk and the smaller lamb will do very poorly.

**Stanchion graft.** A special head gate to restrain the ewe is effective in grafting (fig. 10). The ewe can remain in the stanchion several days, if necessary. Odor from urine, feces, and bedding will cover the lamb and result in acceptance by the ewe. The gate allows the ewe to stand, lie down, and move for comfort. Provide clean water and feed to the ewe and keep bedding changed as needed.

**Hide graft.** The dead lamb is skinned in such a way that its hide can be slipped over the bummer lamb (fig. 11). It is best to leave the tail on the hide, for when the lamb nurses the ewe will smell it. The tail will cover the rear end of the bum-

mer, so its odor will be masked. After 3 or 4 days, the hide can be removed. By this time the ewe can identify her lamb by sight, sound, and smell. Also, a double graft is possible if the dead lamb's hide is split and divided between the two bidders. More risk is involved in a double hide graft for each lamb is not covered as well with the dead lamb's hide. Again, in double grafting, be aware of differences in the size of the two bidders.



Fig. 10. A portable grafting stanchion used in grafting lambs.

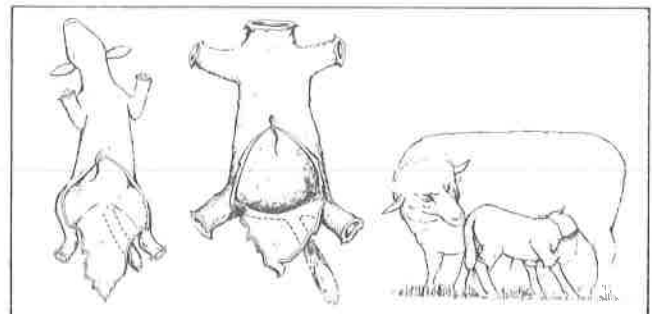

Fig. 11. Procedure for hide grafting.

**Left:** Hide grafting is best accomplished by skinning the dead lamb in the manner illustrated so that a triangular flap of skin is loosened to hang down at the rear of the grafted orphan lamb. After cutting off the fore and rear legs at the knee and hock joints, the hind leg may be doubled at the stifle joint so that the cuff shown on the hock may be slipped over the end of the leg. The tail may be severed at the base and the hide slipped forward over the head to come off fleshside out as with a person removing a slip-over sweater.

**Center:** As the second step, the skin is severed from around the neck of the dead lamb and again turned fleshside in. The hide graft is now ready to go on the orphan.

**Right:** Note that the rear of the orphan is totally covered by the pelt of the dead lamb, the principal opening of the skin being hidden below. Now the mother of the dead lamb, searching for identification by odor, detects only that of her own young. After being dressed in the skin, the orphan should be tied down for 5 to 10 minutes in the same location where the dead lamb was found. This will allow the new mother to become acquainted with the lamb and guard against an unnatural display of activity.

**Other types of grafting.** Varying degrees of success can be obtained, depending on your patience and the ewe's temperament. One technique is to tie the ewe's body so she cannot move and tie one hind leg so she cannot kick. The lamb can nurse as it wishes. After several days, the ewe is supposed to give up and accept the lamb.

Strong smelling materials, such as Vick's "Vaporub" salve or lemon extract, have been rubbed on a lamb and on and in the ewe's nose. Theoretically, the ewe cannot identify the lamb odor so she will accept the lamb out of confusion. Commercially prepared lamb grafting products also are available.

Many experienced sheep producers say that these methods of grafting work best when one has experience and understands how a ewe thinks. The mucous (slime) or hide graft probably works better for the less experienced sheep producer.

### Raising Orphan or Bummer Lambs

If grafting fails, bummer lambs can be saved by raising them on either warm milk or cold milk. Lambs tend to overeat when fed warm milk and warm milk feeding requires extra time and effort. Cold milk feeding requires more equipment, but it is faster and easier if more than three to five bidders are being raised at one time. For more information on cold milk feeding, contact your local farm advisor or Cooperative Extension agent.

Warm milk feeding requires a pop or beer bottle and a lamb nipple, which can be purchased at a livestock supply store. Bummer lambs can be raised on cow's milk, but they grow much faster if they are raised on a commercial lamb milk replacer. This supplemental milk is higher in fat and solids

than cow's milk or calf milk replacers. (Ewe's milk is higher in fat and total solids than cow's milk.) The lamb milk replacer may be more expensive than the calf milk replacer, but the added expense will be worth it. The lambs will grow faster and will be healthier.

A bummer lamb should receive at least one feeding of colostrum milk during the first 12 hours after birth. The first day the lamb should take 2 to 3 ounces of milk at least four times. The second day increase the feeding by 2 to 3 ounces and still feed four times a day. By the time the lamb is a week old it should be consuming 16 to 24 ounces of milk in three or four feedings. Gradually increase the milk intake until at 2 weeks of age the lamb is drinking 16 ounces three times a day. The lamb should be fed at this level until it is about 45 days old or weighs about 30 pounds. At this time the amount of milk fed per feeding can be reduced gradually, provided the lamb is eating dry feed.

Fresh water should be available at all times. Within the first week, high quality dry feed also should be available. At 1 to 2 weeks of age lambs will eat a few alfalfa leaves and some rolled grains. During the nursing period they should have high quality feed available to them at all times. As intake of dry feed increases (after 45 days or 30 pounds of weight), milk intake can be reduced.

If a ewe has triplets or she cannot raise twins because of a poor udder, an alternative to grafting or raising bidders is to leave the lambs with their mother and to train the lambs to nurse the bottle. The training must start within a couple of days of birth. It will take several days to train the lambs. Have patience!

## LAMB MANAGEMENT

### Castration and Docking

To keep the rear area free of feces and moisture, lambs must be docked (tail removed); otherwise, it is possible for flies to lay eggs in the wet manure on the rump and tail. Fly strike or maggot infestation can result, causing crippling or painful death, or both.

Castration of male lambs is necessary to prevent indiscriminant breeding with their mothers or other ewes before weaning. Also, ewe lambs and ram lambs can breed, resulting in unplanned matings.

Depending on the producer's preference, lambs can be castrated and docked at a very young age (1 day to 2 weeks old) or after the lambing season when some lambs may be a month or more old. There are several ways to dock and castrate (fig. 12).



**Fig. 12.** Tools used to castrate and dock lambs. *Top:* burdizzo, used for castration and docking; *center left:* knife used for castration and docking; *center:* elastrator used for castration and docking; *bottom:* emasculator, used to cut off testicles.

**Elastrator.** Use of the rubber or elastrator band probably is the cleanest and easiest method for castration and docking. It requires a special tool (an elastrator) to which is applied a special type of rubber band. Both items can be purchased from a local livestock product supplier or the local veterinarian. The elastrator works by cutting off the blood supply to the testicles and scrotum and tail, causing these parts to wither and drop away.

When castrating and docking male lambs, it is best to castrate first. Place the rubber band on the elastrator. Next set the lamb on its rump with its head resting against your leg. This will expose the lamb's scrotum. Next force both testicles down into the scrotum. With the testicles in the scrotum, place the rubber band on the scrotum above the testicles or between the testicles and the body. Release the elastrator, allowing the rubber band to tighten around the scrotum. Check to make sure both testicles are below the rubber band. If they are, remove the elastrator. Check the rubber band again to ensure that it is intact and in the proper location.

Opinions may vary as to where to dock (remove) the tail or how long the tail stub should be after docking. The following location is acceptable to most sheep producers. There is a fold of skin on each side of the rectum under the lamb's tail. This fold will go from the rectum area to the tail. At that point where this fold connects to the tail is a good place to remove the tail.

When one person is docking lambs, the following procedure is helpful: (1) Place rubber band on elastrator. (2) Kneel on one knee and place the lamb over the other knee. (3) Pick up lamb's tail and slide rubber band down the tail to desired area. (4) Release rubber band and remove elastrator.

Do not become alarmed if the lamb being docked and castrated lies on its side and pants after these operations. Within 10 to 15 minutes it will be up and moving around, free of any reaction.

The rubber band method works best on small lambs. With this technique there is some danger of tetanus infection (tetanus antitoxin vaccination must be given when the bands are applied) and fly strike in warmer climates, but there is no danger from excessive bleeding. The tail and scrotum should drop off in 2 to 4 weeks. Always check for unhealed areas when tails and scrotum drop away. If present, treat with fly repellent. An alternative option is to cut off the tails behind the band about 1 week after the band was applied. Treat the cut area with iodine or fly repellent. This practice will help reduce fly strike problems.

**Knife method.** Another way to castrate male lambs is to cut off the bottom half of the scrotum, then pull the testicles with your teeth, fingers, forceps or special pliers with serrations on them. Also, the testicles may be cut off with an emasculator. This procedure should be done on very young

lambs (less than 1 month old)—there is less stress on them. Sanitation is important; all equipment must be kept clean and disinfected to reduce the chance of infection. Check to be sure both testicles are removed. Occasionally one testicle may remain in the body cavity and cannot be reached. Such male lambs, called Cryptorchids, may be capable of breeding ewes.

**Hot knife or chisel docking.** Tails can be removed by using a hot knife or chisel. It is best to set up a board with a hole through which the tail can be pulled. One side of the board should be covered with metal to prevent the hot iron from burning the board. The board is to protect the lamb's rear end from the hot iron. This method requires two people and energy to heat the tool used to cut off the tail. Properly done, there should be little bleeding, because the hot iron will cauterize the blood vessels. There could be problems if the scab is knocked off before the tail is healed. Lambs docked at an early age show little pain or reaction.

**Burdizzo castration and docking.** The lamb can be castrated with bloodless castrators or a burdizzo, a tool which crushes the spermatic cord above the testicles. If proper castration is done, the testicles are resorbed and the scrotum remains intact. Occasionally, a cord is missed and the testicle develops; also, part of the testicular tissue can be left on the cord and it will continue to develop. In either case, the lamb probably will produce sperm cells at sexual maturity and will develop characteristics of a ram. One other problem may occur with this method: if the crushing is too high, the urethra may be severed and the lamb will die.

The burdizzo also is used to dock lambs. It is clamped on the tail and a sharp knife is used to cut off the tail behind the tool. The tool's crushing action reduces bleeding and shortens blood clotting time. The end of the tail should be disinfected to prevent infection. Care should be taken that the cut end of the tail is not bumped after docking. A bump could start the tail bleeding.

It is not recommended to cut off the tail and use a rubber band for castration if both operations are done at the same time. When the rubber band is on the testicles, the lamb could thrash around, bump the tail and open the wound. This could cause excessive bleeding that could weaken the lamb or even kill it.

**Holding lambs for castration and docking.** Castration and docking can be done more easily by two people: one to hold the lamb and the other to carry out the procedures. It is much easier if the lamb is set on its tail with its back to the person holding it. Next, lock the front legs under the hocks of the hind legs (see fig. 13). The tail and scrotum are easy to reach with the lamb in this position.

If flies are a problem, fly repellent should be applied around the wound and the lambs should be closely watched for fly strike.



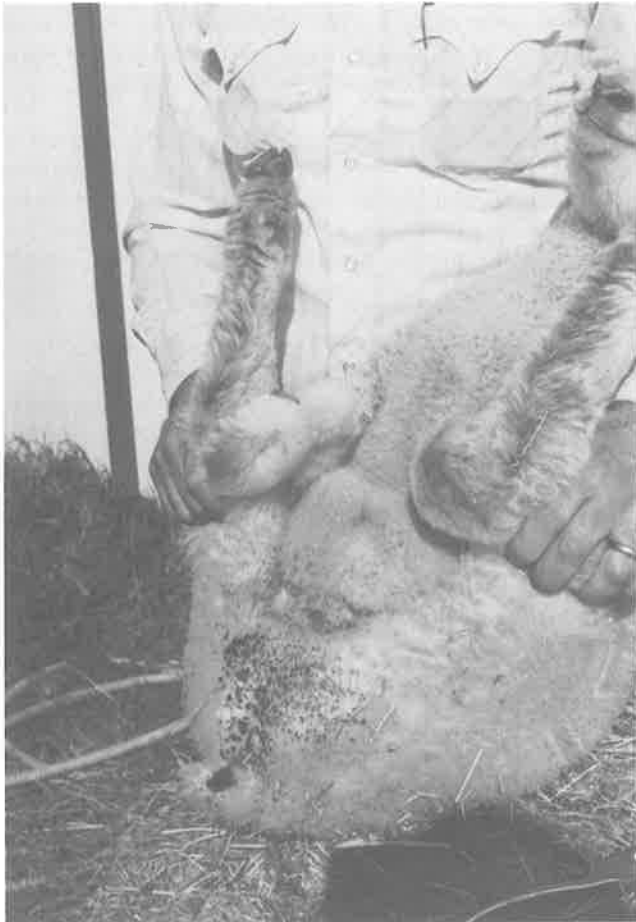

Fig. 13. Correct way to hold lamb during castration and docking. Note that front legs are back under the hocks of the hind legs.

### Treating Inverted Eyelids

Inverted eyelids (entropion) can occur in one or both eyes. The lower eyelid (and occasionally upper eyelid) turns in and the hair on the lid will irritate the eyeball, causing the eye to water. In severe cases, inverted eyelids can cause blindness. *These lambs should not be kept for breeding purposes* because this condition is heritable. The inverted eyelid should be corrected for the comfort of the animal as well as to ensure a good rate of growth. In severe cases lambs will grow poorly because of the constant irritation.

**Cutting method.** The most common method to treat inverted eyelids is to cut out an oblong (football-shape) piece of skin from the lower eyelid about 1/4 of an inch below the upper edge of the eyelid. The piece of skin should be about 1/4 inch wide and 1/2 inch long. This skin can be cut off with sharp scissors. The resulting scar shrinks and holds the eyelid in proper position.

**Bloodless method.** An effective bloodless method employs surgical wound clips. One end of the clip is attached to the

lower eyelid next to the eyelashes and the other end is attached lower down on the eyelid. After the clip is fastened, the lower eyelid is rolled out and down. After several weeks the clips can be removed. This method requires specialized, expensive equipment that is not readily available.

**Injection method.** Finally, one method uses several small injections of an antibiotic under the skin of the inverted eyelid. Consult your local veterinarian.

### Creep Feeding Lambs

The lamb's most efficient growth is during its first 2 to 3 months of life. To take advantage of this, a lamb should be fed a high quality creep feed to maximize growth. A creep is a feeding area only for lambs; ewes are kept out. The creep fence or gates will have one or two areas through which the lambs can enter. These entry areas should have vertical slots about 10 to 12 inches wide. Width of the slots should be wide enough to let lambs in and keep ewes out. It is best to start with narrow slots and increase the width as the lambs get larger. The creep should be located near the place ewes spend most of their time. During their first few weeks, the lambs will want to be near mothers. The creep area should be kept clean and dry and must be attractive to the lambs. Creep feeders should be a convenient height for young lambs and should not be near the entry areas. If feeders are close to entry areas, ewes will spend too much effort trying to get into the creep. Also, if a ewe blocks the entry area lambs will not be able to enter. It is best to keep creep feeders away from the outside where ewes can reach them. Ewes will try to get to the feeders and may break down the creep fence.

**Creep feeds.** Lambs are able to eat small amounts of high quality feeds at 2 to 3 weeks old. High quality, leafy alfalfa hay is a good starter creep feed for lambs. A concentrate grain mix containing 12 to 16 percent crude protein also should be available. Fresh, clean feed should be available at all times. Do not allow feed to become stale in the creep feeder. Clean feeders or troughs as needed. Stale creep feed can be fed to ewes.

**Advantages to creep feeding.** It will take several days for the lambs to start using the creep. Older lambs will start using it first; younger ones soon will follow the older lambs. Once the lambs have started using it they will spend more time there, eating and socializing. The creep feed should be available until they are weaned. Creep-fed lambs will wean more easily than noncreep-fed lambs. The creep will have become a mother substitute, and the ewe's main function by weaning time will be social, not a source of milk.

A weight gain advantage for creep-fed lambs can be realized when the ewes and lambs are grazing high quality pasture. The creep can be placed in the pasture where sheep tend to congregate, such as near shade, water, or feeding areas.

The additional gain by lambs before weaning is important for future management. Wether and ewe lambs to be sold will reach market weight sooner, and less feed will be needed to finish them. Also, replacement ewe lambs will weigh more at breeding time, thereby improving their pregnancy rate.

**Creep feeding and overeating disease.** Creep feeding increases the chances of lambs getting overeating disease (pulpy kidney or enterotoxemia). Creep-fed lambs must be given enterotoxemia shots. (It is a good practice to give all lambs enterotoxemia shots under any type of management. See health section for more details.)

### Weaning Lambs

Lambs can be weaned at 60 to 90 days. They should be placed in a good pasture far from their mothers. Creep-fed lambs should continue to have creep feed during weaning to

reduce weaning stress. In heavy milking flocks, ewes should be placed on poor quality or reduced feed for about 2 weeks after weaning so that their milk flow will be decreased.

In an accelerated lambing program, lambs are weaned at about 60 days. These lambs must be fed a high quality feed before, during, and after weaning. Early weaned ewes should be held off feed and water for 48 hours to reduce milk production. In hot weather provide water to the ewes after 12 hours.

After weaning, lambs should be placed on the best pasture or feed available to maximize growth. Ewes should be placed on the poorest pasture. After weaning the ewe needs only to maintain body weight and does not require high quality feed until just before breeding. Ewes carrying excess fat at weaning time should lose weight between weaning and breeding.

## NUTRITION

Sheep should be fed to meet their productive needs; that is, lactating ewes have increased feed requirements compared with ewes in early pregnancy. A growing ewe will have different requirements from those of a mature, dry ewe. The kinds and amounts of feeds must be fed in different combinations to meet the nutrient requirements for each stage of production.

### Major Nutrients Sheep Need

These are the five major nutrients that sheep require for good health: water; energy, expressed as total digestible nutrients (TDN); protein, expressed as crude or digestible protein; minerals, with salt, calcium, and phosphorus being the most important; and vitamins, with vitamin A and D being the most important.

**Water.** A clean, ample supply of water should be available at all times. The need for water will be higher during hot weather than during cold weather. Lactating (milking) ewes require more water than do nonlactating sheep. Sheep eating dry feeds will require more water than sheep grazing green forage or eating silage. Sheep will not drink enough if the water is dirty or stagnant. Low water intake will reduce feed intake, thus reducing performance and affecting health.

**Energy.** Energy is often deficient in sheep diets. Most of it can be supplied by forages: hay, pasture, or silage. Mature forages are too low in energy to meet the needs of ewes, especially in the last 6 weeks of pregnancy, or for lactating and young animals. Thus, additional corn, milo, barley, or wheat needs to be fed to meet energy requirements.

**Protein.** Most protein can be supplied by high quality forages. Diets containing poor quality pastures or hay should be supplemented with a high protein feed like cottonseed or soybean meal.

**Minerals.** Salt should be provided at 1/4 to 1/2 ounce per head daily. Sheep deprived of salt will not eat or drink enough. Loose or ground salt is preferred to block salt. Sheep will bite block salt rather than lick it, thus increasing their chances of breaking teeth. They can satisfy their salt need faster when fed loose salt and will be able to spend more time eating.

Forages usually contain adequate amounts of calcium, but they are low in phosphorus. Grains generally are adequate in phosphorus and low in calcium. Because sheep consume mostly forages, their diets can be low in phosphorus. Phosphorus and calcium dietary needs can be supplied by providing a four parts salt to one part dicalcium phosphate mix. This mix can be offered free choice.

**Vitamins.** Sheep require vitamins A, D, E, and K, but not vitamin C or the B-complex vitamins which are produced in the rumen (stomach) by bacteria. Most ewe diets contain an adequate supply of vitamins A, D, E, and K; however, diets consisting largely of mature dry forages that are not green will be low in vitamin A. Under most conditions sheep do not require supplementary vitamin A. Vitamin D deficiency is not a problem unless ewes are fed on a vitamin D deficient diet low in sun cured forages, or kept out of sunlight.

# FEED REQUIREMENTS

The feed requirements will depend on the age, sex, and production level of the sheep. These changes will be in the amount of feed as well as nutrient level.

## Feeding Ewes

A ewe's feed requirements will change throughout the year (see fig. 14).

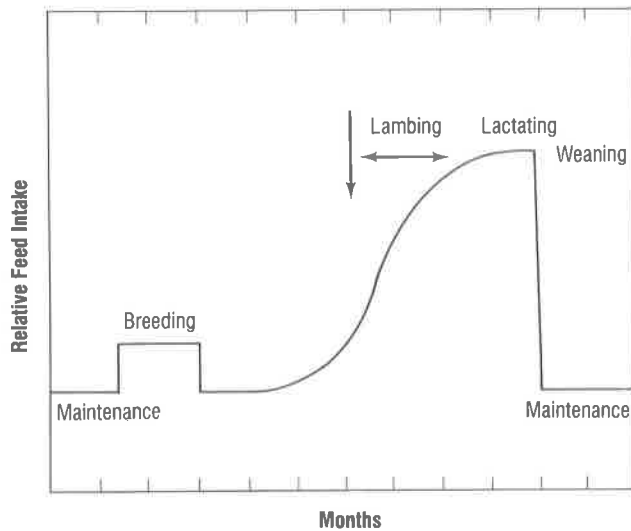

Fig. 14. The relative intake of feed needed by a ewe during various stages of production over a 12-month period.

**Evaluation of ewe's condition.** The ewe's condition (amount and ratio of muscle to fat) should be evaluated in order to help determine her nutritional needs. Weighing the ewe will give a good indication if she is underweight or overweight. Condition scoring is not as good as weighing, but it is much better than simply giving the sheep a general look. Most of the time sheep have too much wool to evaluate their condition accurately.

The best way to check condition is to feel the degree of muscling and fat cover over and around the vertebrae in the loin regions. Look for two bones: the spinous process, which is the vertical portion of the backbone; and the transverse process, which is the horizontal portion of the backbone (see fig. 15). Table 1 describes five condition scores in reference to these two bones.

Score	Area	Condition
<b>1</b> (Very Low)	Spinous	Prominent and sharp
	Transverse	Sharp, can feel underneath them and feel each process
	Eye muscle	Shallow, no fat covering
<b>2</b> (Low)	Spinous	Prominent but smooth (individually felt only as corrugation)
	Transverse	Smooth, rounded, can feel each with a little pressure
	Eye muscle	Moderate, little fat covering
<b>3</b> (Good Condition)	Spinous	Only small elevation, smooth, rounded (individually felt only with pressure)
	Transverse	Smooth, firm pressure required to feel over ends
	Eye muscle	Full, moderate fat covering
<b>4</b> (Fat)	Spinous	Can be detected with pressure as a hard line
	Transverse	Cannot be felt
	Eye muscle	Full, thick fat covering
<b>5</b> (Very Fat)	Spinous	Cannot be felt, but is hollow in back
	Transverse	Cannot be felt
	Eye muscle	Very full, very thick fat covering; may be lumpy over tail and rump

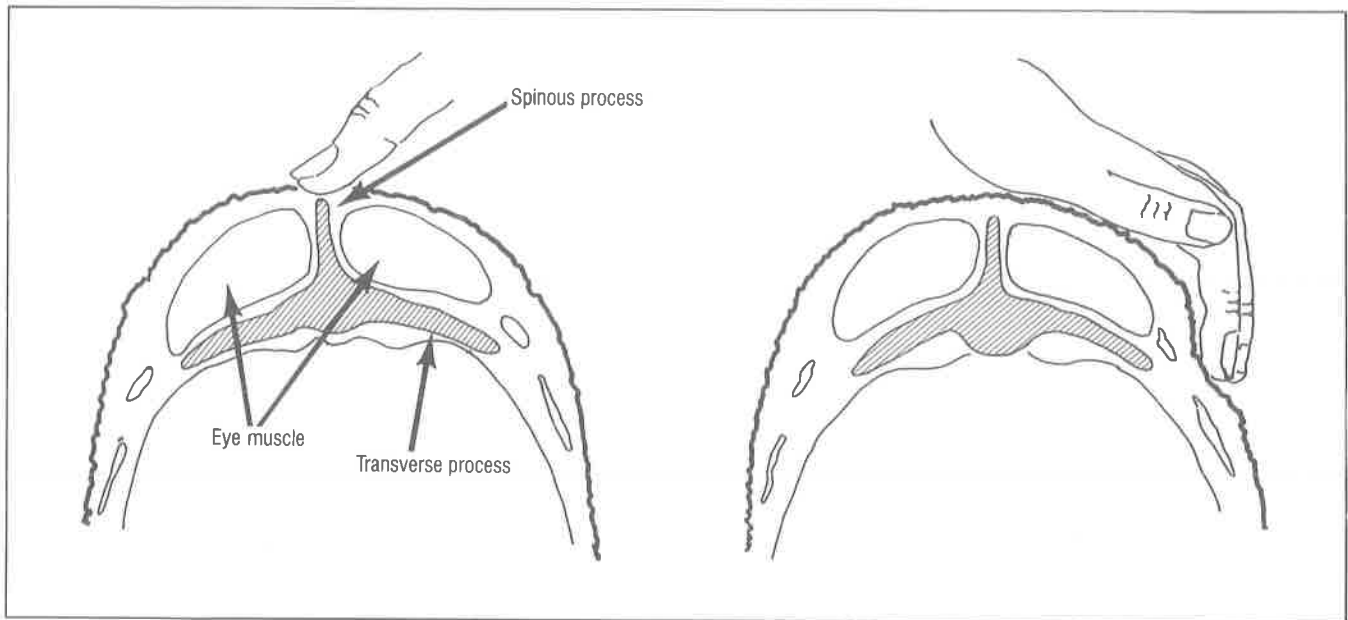

Fig. 15. Cross section of a sheep's loin area showing the spinous process, transverse process, and eye muscle.

**Condition and ewe's requirement.** From the end of breeding to 6 weeks before lambing (early gestation) ewes in good condition (score 3) should maintain their weight. Thin ewes should gain slowly (1/16 to 1/8 pound a day). Ewes that are too thin (score 1 or 2) will produce smaller lambs, death rate of lambs will be higher, ewes will produce less milk and lambing paralysis (pregnancy disease) is a threat.

*Ewes that are too fat during early gestation should lose excess fat.* Ewes that are too fat (score 5) also may develop pregnancy disease during the 4 weeks before lambing, particularly ewes carrying twins or triplets. Prevention through good management and avoiding underfeeding and overfeeding is best for controlling this problem. Lack of exercise by ewes in late pregnancy can contribute to pregnancy disease.

**Maintenance diet.** Three to 3 1/2 pounds of a good quality hay should maintain a 150-pound ewe. Ewes grazing a medium-to-poor quality pasture should maintain their weight. Ewes on short, poor quality pasture may need a hay or grain supplement.

**Late pregnancy needs.** During the last 4 to 6 weeks, when rapid fetal growth occurs, the ration should be increased to meet the needs of the developing fetus. Without increased energy intake the ewe may develop pregnancy disease, a condition that results when the ewe does not receive enough energy to meet her needs and those of the developing lamb. In an energy-deficient condition the ewe draws on her body fat reserves, thereby creating a toxic condition.

A ewe with pregnancy disease becomes lethargic and stands with her head down. She goes off feed or refuses to eat. In the more advanced stages the ewe's breath will smell similar

to that of a person who has been drinking heavily. As the condition progresses, the ewe will "go down" and will not be able to walk. Within a week of onset she could die. One treatment is to induce labor with drugs so that the ewe delivers the lamb; another is to take the lamb by Caesarean section. Either treatment should be performed by a veterinarian.

**Diet the last 6 weeks of pregnancy.** Ewes should gain from 1/4 to 1/2 pound a day. Thinner ewes and ewes carrying more than one lamb should gain at the faster rate. Fat ewes should gain at a slower rate.

Four and one-half pounds of a high quality alfalfa hay daily can provide the ewe with enough energy. If hay quality is medium to poor, the ewe will not eat enough to meet her needs. Additional energy must be supplied with 1/2 to 3/4 pound of grain.

Pasture quality will determine if additional energy is needed. In most cases, pasture quality will not adequately support the 1/2 pound-a-day gain.

**Diet for the first 8 to 10 weeks of lactation.** The ewe's energy needs will be double those of ewes without lambs (fig. 14). Ewes nursing twins will need more energy than ewes with a single lamb; if possible, separate these two groups of ewes. Ewes with twins will require a daily ration of about 5 1/2 pounds of good quality alfalfa hay plus 1/2 to 3/4 pound of grain. Ewes with single lambs at side could be fed the same amount of hay but only 1/4 pound of grain. Ewes nursing lambs and grazing poor quality pasture or fed poor quality hay will need to be supplemented with energy and protein.

**Weaning time.** A ewe's nutritional needs change drastically

(fig. 14). The ewe should be held off water for 6 to 18 hours (depending on air temperature) and off feed for about 24 hours after weaning to reduce her milk flow. Breaking the milk flow apparently helps reduce damage to the udder. The ewe's body condition at weaning will determine her nutritional needs. Very thin ewes should gain at a slow rate (1/2 pound a day). Ewes in good flesh should maintain their weight, and overconditioned ewes should lose weight. Poor quality pasture will be adequate for most ewes at this time. The best pasture and feed should be saved for lambs. Three to 3 1/2 pounds of medium quality hay per ewe per day should be adequate if pasture is not available.

**Ewe's needs before breeding.** Two to 3 weeks before breeding, the ewe's nutrition should be improved by flushing (see section on flushing). A change from poor to good quality pasture may be adequate to get a good flush. When pasture is not available, 1/2 pound of additional grain should provide a good flush.

### **Feeding Replacement Ewe Lambs**

Replacement ewe lambs should be managed differently from mature ewes. Ewe lambs should gain from 1/8 to 1/2 pound a day from weaning to breeding and from breeding to lambing. They also should be fed to gain some weight during lactation. These young ewes are still growing and must have enough feed for milk production plus growth if they are to reach mature weight by their second breeding season.

From weaning to breeding, ewe lambs should gain at a rate that will ensure a weight of 100 or more pounds at breeding. High quality pasture can provide the necessary nutrients to reach this weight. Ewes grazing poorer quality pasture will need additional grain to achieve desired gains. Ewes in drylot would require 3 1/2 pounds of good quality hay and 1/2 pound of grain per head daily to reach the desired weight at breeding time.

**After breeding.** Fat ewes' level of feed should be reduced

slightly at the end of the breeding season. Ewes in good condition should remain on the high level of feed through lambing and lactation. After lambing, ewe lambs should be fed separately from mature ewes and given all the high quality hay they can eat plus 1/4 to 1/2 pound of grain.

### **Feeder Lambs**

The amount of feed a lamb requires and the amount of crude protein will increase as the lamb gains weight. Early weaned lambs and lambs weighing less than 70 pounds should receive a ration high in grain and low in forage which contains about 16 percent crude protein. A ration for light-weight lambs should be about 35 percent roughage (hay) and 65 percent grain and protein supplement. Even lush pasture does not contain enough nutrients for small lambs to grow at a reasonable rate and should be supplemented with protein and energy.

Lambs weighing from 70 to 100 pounds should receive a 60 percent roughage and 40 percent grain ration that contains at least 12 percent crude protein. Lambs in this weight range can consume rations higher in grain, but high grain rations cause digestive problems such as scours, founder, and overeating disease. Lambs in drylot will consume 2 1/2 to 4 pounds of feed per head per day, depending on size. High quality pastures usually are adequate to meet the need for an economical gain for older lambs.

Finishing lambs should gain 1/2 pound or more a day. Also, lambs should have a good fat cover and grade choice by the time they reach 100 to 110 pounds.

### **Ram Feed Requirements**

Most mature rams should be maintained in a good, thrifty condition (score 3). Hard working rams may require some additional energy supplement during or after breeding season. Rams fed in drylot will eat about 1 1/2 to 1 3/4 percent of their body weight and remain in good condition when fed a medium quality hay.

# FLOCK HEALTH

---

Many factors influence your flock's health. You can control two: management and nutrition. Nutrition is covered in another section. Some general management, as it is related to health, will be covered in another section, and some will be considered in this section.

## Stress

Stress, more closely related to disease than to any other factor, comes in many forms and is not always associated with underfeeding or neglect. Climate is one element we cannot control, but we can provide conditions to overcome stress from climate.

Providing shade during hot weather can reduce heat stress. The shade should be well ventilated. Also, plenty of clean, cool water helps reduce heat stress. Time shearing, so that the sheep will have short wool during hot weather, is also helpful.

Mature sheep need protection from moisture more than they need protection from the cold. Poorly ventilated barns can create many respiratory health problems.

Diseases often appear shortly after animals have been moved or worked. Stress from hunger and lack of water should be minimized when hauling sheep long distances. Also, do not work sheep during extreme hot, cold, or wet weather or in dry, dusty corrals. Work sheep on a cool day or a cool part of the day and when handling of the animals can be kept at a minimum. When sheep require a lot of treatment, spread the work over 2 days rather than 1 long, stressful day. Avoid sudden changes in feed or care and try to avoid working sheep during changes in nutrition or management.

Watch your flock closely for sickness during periods of stress. Consult your local veterinarian at the first sign of sickness. Prompt treatment could prevent the disease from spreading.

## General Sanitation

Poor sanitation and poor quality water are associated with disease. Illness also can be caused by bacteria or algae growing in the watering trough.

Feeding and watering equipment should be designed so that the animals cannot contaminate the feed or water with urine or feces. Also, equipment should be designed for easy cleaning. Contaminated feed can spread disease and internal parasites. Spoiled feed that contains mold can cause abortion. Sheep in confinement should not be fed on the ground.

Grazing pasture too closely will create serious internal parasite problems in sheep. As pastures are grazed closer, the number of internal parasites will increase in the flock. If grazing cannot be controlled and the pastures are short, you should have a good worming program.

Barns and corrals should be cleaned in the fall and spring — more often if needed. Bedding and manure should be disposed of in such a way as to prevent the spread of disease. Bedding material from the lambing and mixing pens should not be placed where expectant ewes can come in contact with it. The reason: lambs with scours can contaminate the bedding, and the scour fecal material can get on the udder of a ewe ready to lamb. After birth, her lamb will be exposed to scours-causing organisms at the first nursing.

Demand the health records (the kinds of shots) of purchased animals. New sheep should be given the shots used in your own health program if they have not received them.

Health management is critical at shearing. Insist on clean equipment before starting. (See section on boils for more details.)

# DISEASES

The objectives of this section are: (1) to summarize the general principles of disease control, (2) to acquaint the sheep owner with the more common diseases of sheep, and (3) to provide recommendations for the *prevention* of specific diseases. A veterinarian should be consulted for information on the diagnosis and treatment of specific diseases.

Disease occurs when the balance is upset between an animal's resistance against disease and the factors that cause disease. For a disease control program to be effective, the interaction between the animal, its environment, and the disease agent(s) must be considered. Poor nutrition, bad weather, rough handling, or any other stress lowers an animal's resistance. On the other hand, poor sanitation allows a buildup in the number of disease organisms. As a disease spreads through a group of animals, the agent's virulence (the ability to produce disease) often increases.

## Basic Disease Control Measures

**Sanitation.** The number of disease organisms in the environment are reduced with good sanitation. Attention to cleanliness of feed, water, air, and housing will go a long way toward preventing disease.

**Quarantine (of new animals).** Introduction of new disease organisms is decreased if quarantine is used. Animals that appear normal may be incubating disease; segregated, they can be watched closely, and if no disease develops within 2 to 3 weeks, they can be mixed with the other animals.

**Isolation (of sick animals).** The spread of disease organisms to other animals is reduced and virulence is kept at a low level if sick animals are isolated. In most illnesses, sick animals are the major source of infection for other animals via breath, body secretions, and abnormal discharges.

**Testing.** By identifying the diseases animals have or have had in the past, decisions can be made regarding the disposal of animals and the necessity for various control programs.

**Culling (of infected animals).** The spread of organisms to other animals is prevented by culling. Certain animals will be incurable or chronically infected and unless eliminated from the flock, they will be a constant source of infection for other animals.

**Nutrition.** Properly fed animals are more resistant to disease, and they also recover more quickly from illness.

**Vaccination.** A vaccinated animal's resistance to specific diseases is increased. The protection provided by vaccination can be overwhelmed. Some animals will not be able to respond to the vaccination. As a result, vaccination cannot

be relied upon as the sole method of disease control. Instructions on handling, dosage, and frequency of administration supplied with vaccines must be closely followed to assure success.

**Management.** Conscious efforts to avoid or reduce stress will help to maintain resistance to infectious diseases.

## Common Disease Complexes

**ABORTION.** This abnormal or early termination of pregnancy results from many causes. Although rough handling or fighting among animals can result in abortions, most are caused by fungi, bacteria, viruses, or related disease organisms. Because the exact cause usually is unknown, the aborting ewe, the fetus, fetal membranes, and fluids should be separated from the flock to prevent possible spread of infection to healthy animals.

The fetus and fetal membranes should be submitted to a diagnostic laboratory. Diagnosis should be made as soon as possible so that appropriate steps can be taken to prevent further abortions. The most common infectious diseases causing abortions are vibriosis and enzootic abortion of ewes.

**Vibriosis** is caused by the bacteria, *Campylobacter* (*Vibrio fetus* var. *intestinalis*). Abortion occurs in the last few weeks before birth. The ewe generally does not appear ill afterwards, and the fetal membranes usually are passed normally. Left unchecked, vibrio abortion can spread from animal to animal (via the affected ewe, the fetus, fetal membranes, and fluids) and result in many abortions. Diagnosis can be confirmed in the laboratory.

The best preventive method is to vaccinate the ewes several weeks before breeding. A second vaccination should be given during the first one-third of gestation or pregnancy. After a ewe has received the two-vaccination series, in subsequent years only a single vaccination needs to be given during the first one-third of gestation. In unvaccinated animals, specific antibiotics usually will control abortions until animals can be vaccinated.

**Enzootic abortion of ewes (EAE)** is caused by chlamydial organisms which are classified between bacteria and virus. Abortion from EAE usually is not distinguishable in the field from abortions due to vibriosis. There is a greater chance of having retained fetal membranes with EAE abortions, but diagnosis ultimately depends on laboratory findings.

A vaccine is available for the prevention of EAE. In the face of an outbreak, specific antibiotics can be used to bring outbreaks under control.

**EPIDIDYMITIS.** This disease refers to inflammation of the epididymis, the tubules that carry sperm from the testicles; the term, however, is now commonly used to refer to any lesion in the epididymis or testicle. The disease can be caused by many different types of bacteria, including *Brucella ovis*, *Actinobacillus*, and *Corynebacterium*. In true epididymitis, the tissues lining the epididymis are damaged and sperm leak into the surrounding tissues. The body reacts to the escaped sperm by building up scar tissue which can be felt as hard lumps along the epididymis. This type of lesion is most commonly associated with *Brucella ovis*. The other types of bacteria can cause an orchitis, an inflammation of the testicle, and abscesses in the epididymis or testicle. On palpation it is often impossible to distinguish the various types of lesions. Because of differences in control programs, *Brucella ovis* epididymitis will be discussed separately from the other types.

*Brucella ovis* epididymitis may render the ram partially or completely infertile. The disease is transmitted when a clean ram breeds a ewe that has recently been bred by an infected ram or when rams attempt to breed each other. The disease is transmitted to the ewe during breeding. Although the ewe can eliminate the bacteria from her reproductive tract, the developing embryo may be affected. This can result in an extended lambing season, a higher-than-normal percentage of dry ewes, abortions, or weak lambs.

Prevention can be accomplished by one of two methods. One method involves the use of a vaccine, which must be given to ram lambs at 4 months of age and again at 6 months of age to be effective. Yearly booster vaccinations also are necessary. One problem with vaccination is that it cannot be utilized along with an eradication program.

The second method, eradicating the disease organism from the flock, requires that the vaccine not be used because the rams are blood tested to make certain they do not have the disease. Vaccinated animals have a positive blood test. Initially, all rams are blood tested and any positive rams are culled. An ideal time to start testing is 6 to 8 weeks after breeding season when rams are most likely to have transmitted the disease to one another. This procedure is repeated at 6-week intervals until all rams test negatively. Any new rams introduced into the flock also are blood tested. Rams are then routinely palpated before and after the breeding season. Any ram with palpable lesions of the epididymis or testicles is blood tested. If the test is positive for *Brucella ovis*, then the entire ram flock is blood tested as noted until the organism is eradicated again.

Regardless of the method used, all rams should be palpated several months before and after the breeding season. Any rams with lesions should be culled.

Other types of epididymitis and orchitis not only can make the ram partially or completely infertile, but they also can mimic the lesions caused by *Brucella ovis*. No effective pre-

ventive procedures are available; palpation and culling are the only options.

**MASTITIS (inflammation of the udder).** The disease usually occurs at lambing or within a few days afterwards. *Pasteurella* and *Staphylococcus* bacteria are the most common causes. In the ewe, mastitis often causes death and should be treated immediately. The affected half of the udder often is destroyed, in which case the animal should be marked for culling. Mastitis occurs more often with barn lambing than with range lambing and increased sanitation in the barn will help control it. Early detection, including checking the udder at lambing, watching for swollen or hard udders or for ewes that will not permit nursing, is important if treatment is to be successful.

**NAVEL ILL (joint ill).** The wide variety of bacteria that cause this illness gain entrance to the lamb's body via the umbilical cord after birth. Once the bacteria enter, they can multiply and cause a generalized illness, or they may become isolated and form local abscesses. The most common sites for abscesses are the liver and leg joints. Animals with an affected joint will be lame and will have a hot, swollen, painful joint. This type of infection is difficult to treat, and the lamb usually is crippled for life. Navel ill can be prevented by following two procedures: (1) Immediately after birth, dip the navel stump in 7 percent tincture of iodine to dry out the navel cord and to kill any bacteria present; dip cord again several hours later. (2) Permit lambing only in a clean environment — in barn lambing, jugs should be cleaned and disinfected between births.

**PNEUMONIA.** The term is used all-inclusively for an infection in the lungs, without saying anything about cause. Pneumonia can occur at any age, but it is most commonly seen in very young lambs and at weaning. Generally a virus, combined with stress, causes the initial damage. Bacteria invade secondarily and produce the signs we recognize as pneumonia. An affected animal becomes lethargic, has a high fever, and may have labored breathing and a nasal discharge. Prevention in the lambing barn calls for adequate ventilation and prevention of drafts. Anything that reduces stress will help prevent pneumonia.

Experimentally, an intranasal (not intramuscular) IBR-PI<sub>3</sub> vaccine licensed for use in cattle appears promising as an aid in the control of pneumonia in sheep. More research is needed before the vaccine can be licensed for use in sheep.

**SCOURS.** This general term is used for diarrhea (loose stool) without specifying the cause. If an inadequate diet (too little fat) is fed, "nutritional" scours may occur; however, most cases are in lambs and are caused by bacteria (*Salmonella*, *Escherichia*) or virus. Regardless of the cause, the net effect is that the lining of the intestine becomes irritated, and fluid is lost into the intestine instead of being absorbed from the intestine into the body. Animals, especially lambs, with scours usually die from dehydration (loss of body fluids)



rather than from other effects of the bacteria or virus. Immediate administration of fluids is vital. Because there is no vaccine available to prevent scours, sanitation is critical. As soon as an animal develops diarrhea, it should be separated from the other animals and treated. In a lambing barn it is essential that lambing pens be cleaned and disinfected between births.

The first milk from the ewe (colostrum) contains antibodies that help protect the lamb from scours and pneumonia. The lambs should receive colostrum (a minimum of 4 ounces) right after birth. Colostrum should be force fed to lambs that won't nurse. Shearing or tagging the ewe's rump and area around the udder will help prevent the newborn from trying to nurse on tags of wool soiled with fecal material and potential scours-causing organisms.

## Specific Diseases

**BLUETONGUE.** Bluetongue is caused by a virus transmitted from animal to animal by a tiny biting gnat. It occurs during dense gnat activity. In California, most cases are seen in late summer and fall. Affected animals develop a high fever and may have swollen faces and ears. When lameness occurs, the junction of the hoof wall and the skin may become inflamed (reddened). Ulcers may be seen on the gums of the mouth. As the disease progresses, there is usually a nasal discharge. Many affected animals develop a secondary pneumonia. Pregnant ewes infected with the virus in the first third of gestation may produce deformed or dummy lambs.

Logically, one way to prevent the disease would be to control the gnat; because these gnats breed in muddy areas around fresh water streams, drain canals, and organically rich ponds, elimination of their breeding sites is difficult. Also, gnats can fly several miles, and areawide control often is not practical. Because the gnat is most active in the evening and at daylight, small flocks can be protected by bringing them into a barn before nightfall. Shearing in late summer and fall seems to attract gnats. So this should be avoided in high risk areas; insecticide spraying or dipping of animals during this critical period can help reduce attacks.

Of the four types of virus common in California, vaccines are available for three. Because there is virtually no cross protection between types, all three vaccinations must be used. Sheep should be vaccinated before the breeding season because each modified live virus could conceivably damage the developing fetus. The animal needs time to develop resistance before it becomes pregnant.

**BOILS (Casesous Lymphadenitis).** After gaining entrance to the body via a break in the skin, the bacteria *Corynebacterium pseudotuberculosis*, which are responsible for boils, localize in a lymph node where they produce an abscess. Lymph nodes most commonly affected are those behind and under the jaw. The abscesses develop a thick wall that antibiotics cannot penetrate well. When they are located internally, they lead to gradual wasting of the animal; when they

break open, a thick greenish yellow material drains out that contains millions of bacteria that are a source of infection for other animals. The bacteria can survive in the soil for a long time.

This is an extremely frustrating disease to control because there are no commercial vaccines available in this country. In desperation people have tried making autogenous vaccines (made from organisms collected from a specific ranch) or have tried adding organic iodides to the feed, all with mixed success. Sanitation is the best control. Whenever an abscess site breaks open, the material should be disposed of and the abscess site should be flushed with iodine. All shearing wounds should be treated with iodine. When an abscess is broken open during shearing, the equipment that came in contact with it should be thoroughly disinfected before shearing resumes. Because younger animals are less likely to have abscesses, lambs should be sheared first.

**ENTEROTOXEMIA (overeating disease, pulpy kidney).** This disease is caused by a bacterium, *Clostridium perfringens* (usually Type C or Type D). The bacteria are present in the animal's intestine, and when there is a digestive upset from overfeeding or from changing the type of feed too rapidly, the bacteria multiply in large numbers and produce a strong toxin that can kill the animal within hours. Often animals are found dead without having indicated any sign of illness. In some cases diarrhea and convulsions precede death. Generally the healthiest, fastest-gaining lambs are affected first.

The disease is best prevented by vaccination and good feeding management. Ewes can be vaccinated with a Type C and D bacterin/toxoid. Two vaccinations must be given the first year, followed by a booster in subsequent years. By giving the vaccinations during late pregnancy, protection will be passed on to the lamb via the colostrum and normally will last until it is 6 to 12 weeks of age. At this time, the lamb should be vaccinated twice, at 6-week intervals, with the Type C and D bacterin/toxoid.

If an outbreak occurs, the following practices may be helpful (alone or in combination): (1) Inject all animals with enterotoxemia antiserum (expensive). (2) Add antibiotics to the feed. (3) Change pastures or take off pasture and put in drylot. (4) Reduce bunk space to increase competition for feed. (5) Sort animals by size so larger lambs can't crowd out smaller lambs. (6) Castrate and dock tails if possible (to throw lambs off feed).

**FOOT ROT.** A bacterium, *Bacteroides nodosus*, causes foot rot. The bacteria live in the wall of the hoof and sole, dissolving the tissues into a foul smelling, grey liquid. The animal becomes lame and production is lowered. The disease is highly contagious among animals. Anything that causes injury to the foot (gravel, wet conditions) will promote spread of the disease. The bacterium can remain alive in the soil for only up to 2 weeks. As a result, the disease can (and should)

be eradicated from the flock, but careful attention must be given to details and procedures. For more details for control see Appendix C.

Although foot rot vaccines are available in other parts of the world, none is licensed for use in the United States. Field trials to evaluate the efficacy of the vaccines in the United States are currently underway.

**PREGNANCY TOXEMIA (twin lamb disease, lambing paralysis, ketosis).** A metabolic disturbance rather than an infectious disease, pregnancy toxemia occurs when the pregnant ewe does not take in enough carbohydrates or energy to meet her requirements and those of her fetus. Signs of disease are related to the degree of blood sugar deficiency. Affected ewes may lag behind the rest of the animals, may appear to be blind and may eventually lie down, unable to rise. The disease occurs in the last few weeks before delivery and is more common in ewes carrying multiple lambs.

Prevention is important because treatment generally is ineffective (both lamb and ewe often die). Prevention involves: (1) Avoiding excess body weight. (2) Avoiding interruptions in feeding due to environmental or management causes. (3) Feeding diets that are adequate in energy (especially in the last 6 weeks of gestation). Supplementary feeding of pregnant ewes during the weeks before lambing often is advisable.

**SOREMOUTH (orf, contagious ecthyma).** The condition is caused by a virus that can cause localized blisters and scabs anywhere on the skin, but most commonly on the lips and nostrils of lambs and on the teats of ewes. The virus can survive for years in the environment and enters the skin via scratches and abrasions.

Lambs generally do not die from the disease; however, feed intake is drastically reduced until it runs its course — usually 3 to 4 weeks. When it spreads to the ewe's udder, more serious complications — such as mastitis — may occur.

Once soremouth becomes established by natural infection or by artificial infection with the live, unmodified vaccine virus, vaccination of replacement adults and of lambs will become necessary on a yearly basis. One- to two-month-old lambs are vaccinated at marking time. The live virus present in the vaccine is applied to scratched skin at a "harmless" site (inside the ear, inside the thigh, or on the tail folds). A local infection occurs with formation of a sore and then a scab. At the same time, immunity against subsequent infection develops.

Both the vaccine and natural causes of soremouth can produce a painful lesion, resembling a boil in people. Care must be exercised in handling the vaccine and infected animals.

**TETANUS (lockjaw).** The bacteria, *Colstridium tetani*, cause tetanus. The bacteria form resistant spores which survive in the environment for long periods. When the spores get into deep wounds where there are anaerobic conditions (a lack of oxygen) they multiply, producing a strong toxin that affects the nerves. Affected animals become progressively stiff until they are completely rigid, with legs extended. Tetanus is most commonly seen in lambs a few weeks after tail docking and castration. Use of elastrator bands occasionally is associated with an increase in the occurrence of tetanus because of the anaerobic conditions produced under the bands.

Prevention of tetanus includes: (1) docking and castration in temporary corrals (not using the same area year after year); (2) keeping equipment clean and storing it in a disinfectant; and (3) injecting the lamb with 200 to 250 units of tetanus antitoxin at the time of docking and castration, if tetanus has been a problem in the past. The antitoxin will protect the animal for the 3 weeks it takes the wounds to heal.

An alternative to this is vaccinating ewes with tetanus toxoid several weeks before lambing. Immunity will develop and will pass to the lamb in the colostrum long enough to protect the lamb through docking and castration. The vaccination schedule for this alternative is similar to the one given for enterotoxemia.

**WHITE MUSCLE DISEASE.** An inadequate intake of the trace mineral selenium causes this disease. Many areas in California are known to be selenium deficient. If there is any question about the selenium status of animals, blood samples should be taken and analyzed for selenium levels. Signs of disease range from depressed weight gains, to stiffness in walking, to sudden death. Supplemental selenium can be provided by injection or added to feed or salt mixes. Selenium injections usually are given to the ewe before lambing or to the newborn lamb, or to both. Because too much selenium is toxic, there are federal regulations governing the amount to be used in salt and feed mixes. Within a few years selenium "bullets" (special hardened pellets that slowly release selenium) should become available. If you have a question about the availability of selenium in your area, contact your local University of California Cooperative Extension livestock farm advisor.

Table 2

**Sample Sheep Herd Health Program**

<b>Period/Activity</b>	<b>Disease</b>	<b>Method of Control</b>	
Prelambing: ewes	White muscle	Selenium injection	
	Enterotoxemia	Vaccination with Type C and D bacterin/toxoid	
	Tetanus	Vaccination	
	Pregnancy toxemia	Adequate nutrition	
	Abortion	Isolation; sanitation; get diagnosis	
Lambing: ewes	Mastitis	Sanitation; check udder	
	Scours	Sanitation; isolation; prompt treatment; adequate colostrum	
	lambs	Pneumonia	Reduce stress; adequate colostrum
		Navel ill	Iodine navel cord; sanitation
		White muscle	Selenium injection
Marking lambs	Soremouth	Vaccination	
	Enterotoxemia	Vaccination	
	Tetanus	Vaccination	
Shearing lambs and ewes	Boils	Shear younger lambs first; sanitation	
Prebreeding: ewes	Vibrio	Vaccination	
	Enzootic abortion	Vaccination	
	Bluetongue	Vaccination	
	Foot rot	Inspect; trim; footbath	
	rams	Epididymitis	Palpation; vaccination
		Foot rot	Inspect; trim; footbath
Postbreeding: ewes	Vibrio	Vaccination	

# PARASITES

Numerous parasites attack sheep, spending all or part of their lives in or on the host animal. Serious damage from parasites results in impairment of growth and development, and weakness in lambs, and increased susceptibility to diseases in older sheep. Severe injury and even death can occur, but these conditions are related primarily to the type and number of parasites present and the length of time over which they are acquired.

Symptoms associated with internal parasites are weakness, emaciation, loss of appetite, jaundice, anemia, intermittent diarrhea and constipation, chronic cough, lameness, and swelling of the jaw and abdomen in extreme cases. External parasites may cause some of the same symptoms associated with internal parasites, plus loss of wool, excessive nasal discharge, central nervous system disorders, and constant rubbing and biting of affected body areas.

Since parasitism is more commonly a flock problem, and not limited to a single animal, sheep owners are responsible for good management and sanitation to prevent parasites in or on their animals. Veterinary assistance is more important in diagnosis and treatment before parasite problems become serious.

## External Parasites

**TICKS.** The Pacific coast tick, *Dermacenter occidentalis*, is found chiefly in central to southern coastal areas, but also may occur in the northern Cascade Range and Sierra Nevada's western foothills. This tick blood-feeds on many animals (rodents, deer, horses, dogs) during its 2- to 3-year life cycle from egg to adult (fig. 16). Adult ticks are commonly found on sheep when they have contact with grass and low shrubs on which ticks have climbed to search for a passing host. This species does not transmit any disease agents to sheep, but it is responsible for causing tick paralysis in cattle, horses, and deer, and the transmission of bovine anaplasmosis and Colorado tick fever in humans. Sheep may be infested during period between fall and spring, particularly if flocks have been ranged in brush covered and natural grassland. Confined sheep usually are tick-free.

Particular attention should be given to searching for ticks around the head, on the inner surfaces of the front and hind legs and on the buttocks. Sheep can be sprayed, dipped, or hand washed with several insecticide formulations, and single treatment is effective unless animals are returned to rangeland infested with ticks.

The spinose ear tick, *Otobius megnini*, attacks all domestic livestock as well as coyotes, deer, rabbits, and pets. This tick

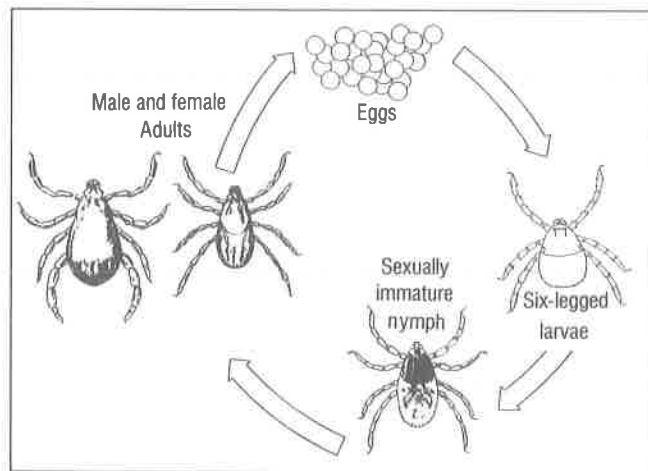

Fig. 16. Life cycle of Pacific Coast tick.

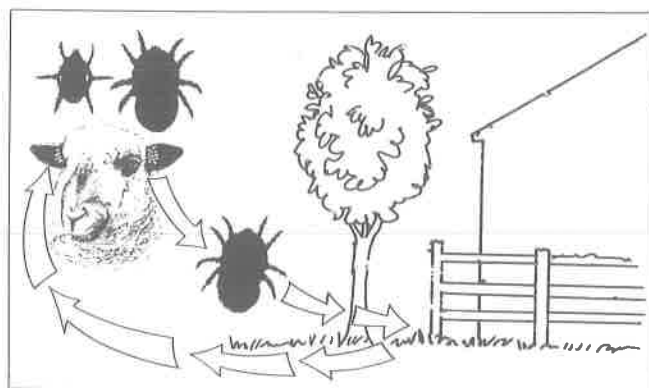

Fig. 17. Life cycle of spinose ear tick.

is found only in the ears of animals and is more commonly associated with sheep kept in warm, dry regions of the state. Tick larvae (seed ticks) and nymphs blood-feed in the deeper folds of the ear causing irritation, head rubbing and droopy ears. Nymphal ticks drop out of the sheep's ears and crawl into hiding places on wooden corral posts, feed troughs, sides of barns, and under the bark of trees, where they change into adults, mate, and begin egg laying (fig. 17). Larvae hatched from eggs crawl onto sheep which feed or bed near such constructions or natural structures. These ticks are difficult to control. Infested sheep must be treated with dust or liquid insecticide formulations applied directly into both ears. A rubber-tipped oil can is best for applying liquids into the ear. Inspections should be made of other animals on the property, including pets, and all infested animals treated. Repetitive ear treatment is necessary to eliminate this tick and replacement stock should be thoroughly examined before entry to the ranch property.

The sheep ked, *Melophagus ovinus*, is commonly called a tick because of its flat, crablike appearance in sheep fleece. The ked, a wingless fly, does not lay eggs, but gives birth to living young, which are full grown maggots (larvae) that fasten to the staple with a gluey substance. Within a few hours the maggots turn into brown colored puparia and adult keds emerge in from 2 to 4 weeks, depending on summer or winter temperatures (fig. 18). Keds always stay on sheep and breeding is continuous all year. They are more common on sheep in mountain and foothill regions or in coastal areas subject to moist, cool weather. Infestations usually occur from fall through spring and may cause considerable irritation and blood loss. Animals left untreated become nervous and vigorously rub, scratch, and bite their wool. Lambs suffer more than mature sheep and may fail to gain from loss of appetite and anemia. One can examine affected sheep by parting the wool — particularly on the shoulders, sides, thighs, and abdomen.

Keds are very easily controlled by dipping or spraying sheep. Replacement ewe lambs, particularly if purchased from cold northern regions, should be routinely treated for ked and louse control before placing them in contact with the ranch flock. Spring shearing will eliminate most, if not all, keds. It is important to gather and store the wool in an area apart from the lambs. Keds normally will die in 4 days when separated from the host animal.

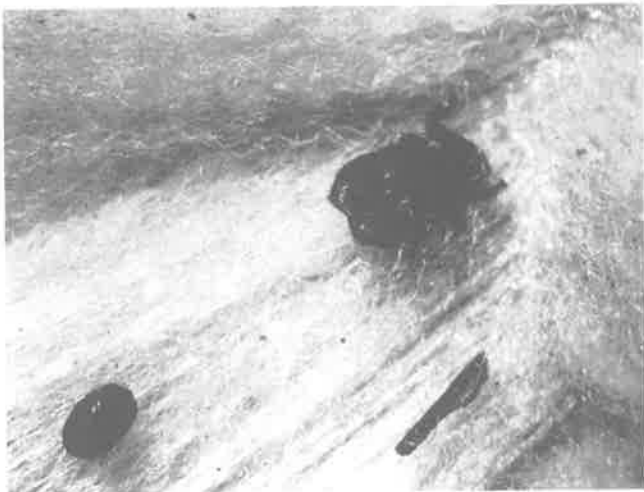

Fig. 18. Sheep ked: pupa and female ked.

**LICE.** Sheep are infested by two types of lice — bloodsucking (Anoplura) and chewing (Mallophaga). Like the sheep ked, lice are a common cold weather parasite and are more prevalent on sheep in mountainous and coastal regions. Both types of lice have similar cycles and times for development. Eggs (nits) are glued to the staple, and after hatching, adults usually appear in 4 weeks (fig. 19). Lice are wingless and transferred by contact between animals; this occurs more often when sheep are penned and closely crowded. Certain mature sheep are particularly susceptible to louse infestations. These animals (carriers) should be carefully inspected and treated before introducing them into ranch flocks.

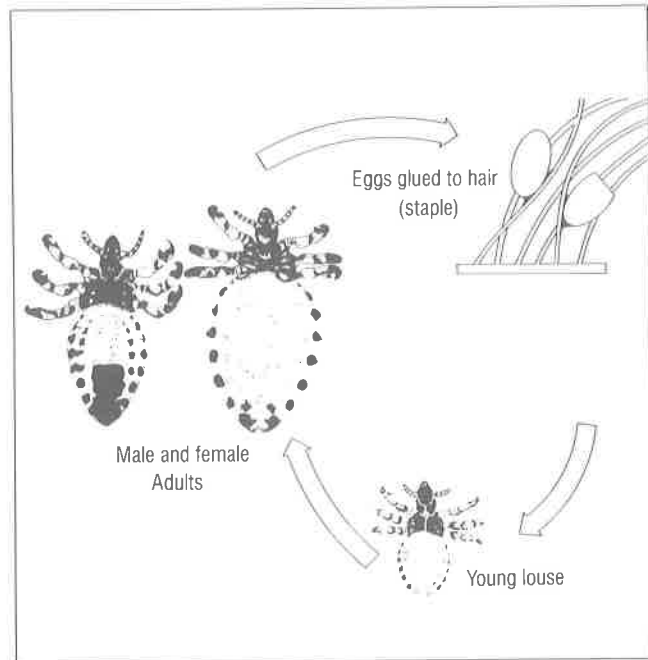

Fig. 19. Life cycle of bloodsucking louse in sheep.

Lice can occur on all body regions, but on sheep one species prefers the area of the dew claws on the legs while other species infest the body, clustering in large numbers, usually identified by matted wool on the back and flanks. Sheep become extremely nervous and constantly scratch, rub, and bite to relieve the irritation caused mainly by the chewing lice. Bloodsucking lice may cause severe anemia if sheep go untreated, and this contributes to stunted growth in young stock and to loss in weight in older animals. Insecticides for louse control are the same as those used for keds.

**BLOWFLIES AND WOOL MAGGOTS.** Blowflies comprise a large number of different types, all of which are known under the same common name. They have similar life cycles and adult behavior. Blowflies are more common during early spring and fall, and adults may be seen resting on outside sunny surfaces of buildings and in plant growth adjacent to barns and corrals. They have a long flight range and may travel several miles. Female blowflies lay eggs (blow) on animal carcasses and decomposed offal, but they also may select a wide range of moist, decomposed plant material.

The black blowfly (*Phormia regina*) and the secondary screw-worm (*Cochliomyia macellaria*) most commonly lay eggs in the necrotic tissue of sheep wounds (from shearing, castration, docking). Green and blue blowflies (Phaenicia and Calliphoridae species) lay eggs in similar wounds, but they also may "blow" stained wool and maggots may be found, particularly around the breech. Good sanitation is important around sheep pens and chutes where shearing and surgical operations are conducted. Docking should be completed before the arrival of warm spring weather and all tail wounds should be sprayed or smeared with an insecticide to prevent fly strike. Similarly, sheep should be collected within 24 hours

after shearing and insecticide-treated on a flock basis or individually for those animals with obvious shearing wounds. Dip or spray procedures are best for flock treatment, whereas, single animals can be spot-treated with smears or with aerosol sprays. In hot arid areas where blowflies may be active before lambing, the udder and vulva of tagged ewes should be routinely inspected for fly strike. Also, those operators who use lambing sheds or shelters should replace urine- and manure-soaked bedding on a weekly basis to avoid fly breeding in such contaminated sources.

**NOSE BOTS.** Nose or head bots are the larvae (maggots) of a nonbiting fly, *Oestrus ovis*. Adult flies annoy sheep when they deposit live maggots in or around their nostrils. The persistent attack by female flies causes sheep to bunch together, hold their heads close to the ground, or to seek escape by remaining in shaded or brushy areas. Fly attacks are more common in late summer and fall in northern regions, whereas, adult fly activity can occur during spring and fall in hot, arid southern areas.

The maggots crawl up the nasal passages, increasing in size until they come to rest in sinus passages. Mature maggots then retrace their journey down the nasal passages and drop or are sneezed out of the nose to fall on the ground where they later emerge as adults (fig. 20). This entire cycle takes 1 year in cold northern regions, but as short as 6 months in warm southern areas. Infested sheep often hold their heads to one side and may turn in circles, run into each other or into posts, or merely stand with their heads pressed against fence posts. Dense maggot infestations cause excessive pus formation, hence the term "snotty-nose." Such other factors as pebbles, burrs, and secondary bacterial infection from abraded sinus passages may produce a similar discharge of pus from the nose.

There is no sure method of preventing fly attack. Smearing sheep's nostrils with tarlike preparations is an age-old remedy, but requires almost daily application and is not practicable under pasture or rangeland management. Nasal passages of "snotty-nose" sheep in fall and winter can be irrigated or flushed with various chemical solutions, but veterinary consultation for such treatment is recommended.

## Internal Parasites

**Feces collection for laboratory analysis.** To detect internal parasites, submit a feces (droppings) sample to a diagnostic laboratory or local veterinarian to help identify the type and the number of parasites present in your animal. The following recommendations are given for collection of feces to be examined for worm egg counts in the laboratory:

1. Collect only *fresh droppings*. Samples picked up from the ground may be too old and may be contaminated.
2. If animals are scouring (diarrhea), try to collect 1 to 2 ounces of liquid feces as discharged from the anus in a small plastic bag (sandwich type), screw-top jar, or cardboard carton. Similar containers can be used in which to place solid droppings (about 5 or 6 pellets but no more). Tightly tie or cover the containers and identify on paper attached to container the owner's name, date sample was taken, and name or number of animal.
3. Store containers in a *cool place* until delivered to the laboratory. **DO NOT** store container in a warm area (in a pickup truck or in a shed, etc.) for 1 hour or more since worm eggs — if present — will hatch and laboratory diagnosis will be in error.
4. Collect a representative sample: 20 percent in a flock of 100 animals or from all animals in a small flock of 15 to 20 heads.

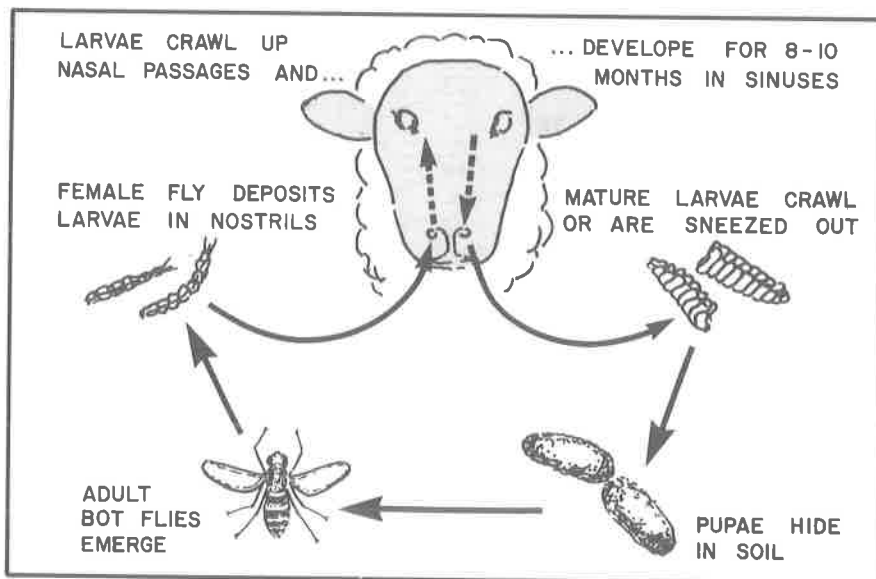

Fig. 20. Life cycle of sheep nose bot fly. Larvae crawl up nasal passages and develop for 8-10 months in sinuses.

If your sheep require treatment for internal parasites, ask your veterinarian to prescribe a drug. Most drugs for this purpose are given as a drench. Drenching should be done by an experienced person, since improper administration can cause serious mouth and throat damage as well as pneumonia or drowning if fluid is forced into the lungs. A drench gun is necessary to administer the drug. The automatic drench gun (fig. 21) is fast and easy when treating many animals. A single dose gun can be used, but it will be slower and not as easy to use. Make sure the single dose gun has a bulb on the end that goes in the sheep's mouth. The bulb stimulates the sheep to swallow, thus reducing the chance of getting drench fluid in the lungs (see fig. 21).

Before drenching, make sure there are no rough or sharp edges on the drench nozzle that could damage the sheep's mouth. Also, make sure that the bulb on the end of the drench nozzle is secure. These bulbs have been known to become loose and sheep have swallowed them.

For drenching, the sheep should stand quietly. Place a free hand under the jaw to hold the head. Next, slide the nozzle of the drench gun in the side of the mouth. This should force open the sheep's mouth. Gently slide the nozzle over the back of the tongue (fig. 22). Slowly pass or deliver the desired amount of drench drug into the sheep's throat. If the fluid is forced too fast, the sheep will not be able to swallow fast enough, and some material may get into the lungs.

### Specific Internal Parasites

The coccidia (protozoa) and the helminths are of concern to the sheep owner. The helminths are often referred to as roundworms (nematodes), tapeworms (cestodes), and flukes (trematodes). Parasites in each group have distinctive life cycles, and these are important to learn to better understand the recommendations for flock management and use of anti-parasitic drugs.

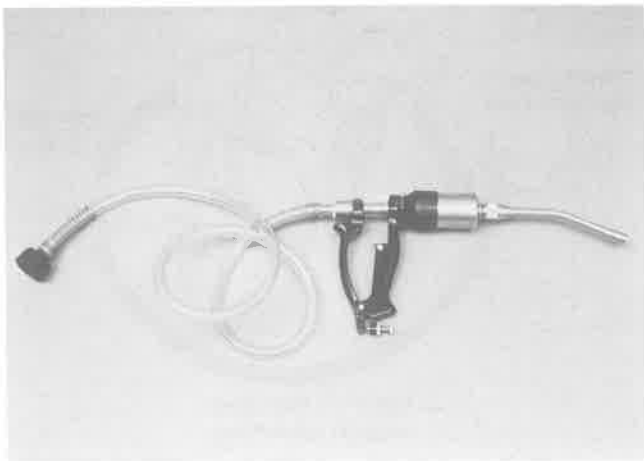

Fig. 21. An automatic drench gun.

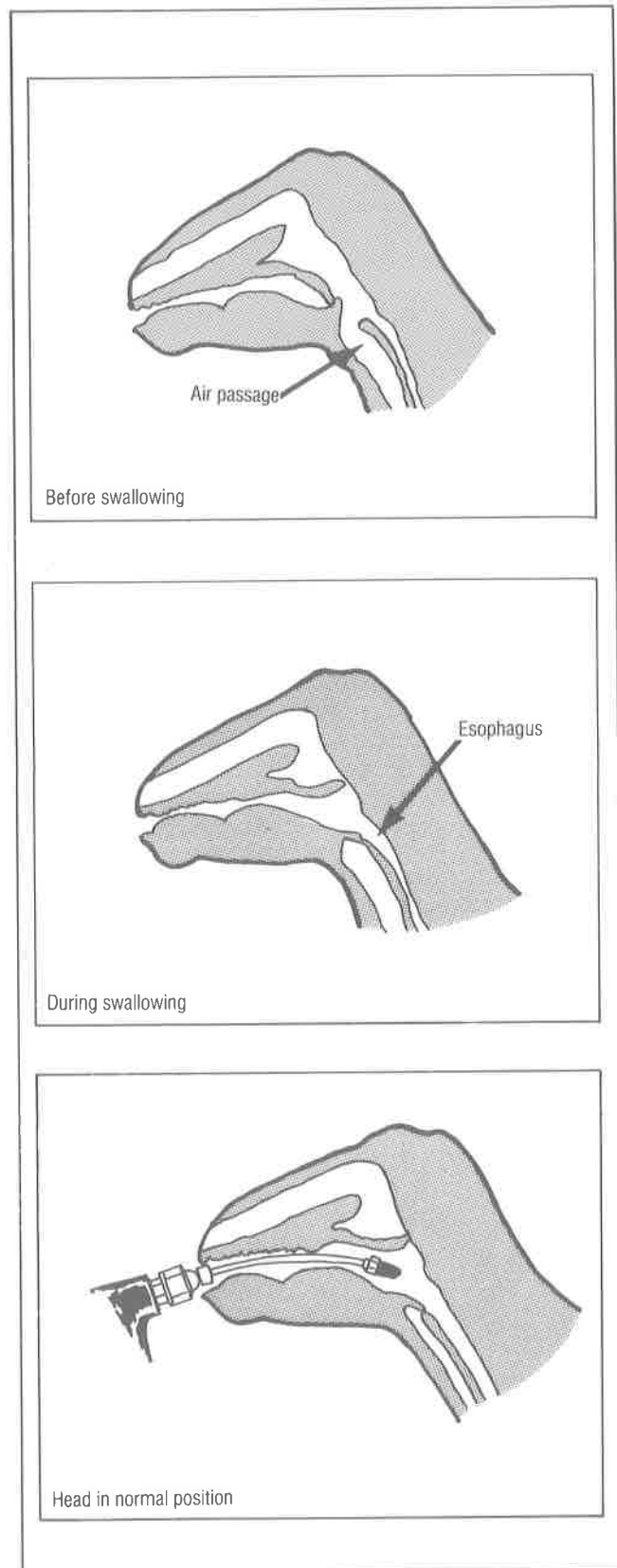

Fig. 22. The swallowing process and how the drench nozzle fits into the sheep's mouth.

**COCCIDIOSIS.** Commonly an intestinal disease of young sheep in farm flocks, feedlots and sales yards, it may occur in range flocks under certain conditions. This disease involves various agents called *Eimeria* that are widely distributed in nature and may remain alive for many months on moist, grassy pastures and meadows. Extreme dryness or direct sunlight will kill many infective forms. When ingested, the infective forms (oocysts) enter cells lining the intestine and multiply by the thousands in 2 to 3 weeks. New forms emerge from the tissue cells and are passed in the feces onto the pasture. These contaminant forms (oocysts) change into infective stages in from 2 days to several months, depending on weather conditions, type of soil, and plant cover (fig. 23).

Infective forms of *Eimeria* cause massive tissue cell destruction in the gut. Lambs, in particular, show a loss in appetite, wool-slipping, and bloody diarrhea in from 2 to 3 weeks following arrival from areas relatively free of this disease. Lambs may be immune if they come from areas where coccidiosis exists. Although they remain healthy, they also can be carriers of *Eimeria* and can act as contaminants by spreading infective forms into the new environment.

Prevention of coccidiosis can be done with proper management. One should try to reduce infection levels — particularly in range flocks — by constructing water troughs fitted with float valves and off-ground feed bunkers, or alternate supplement feeding in different areas each day. Because one cannot predict when disease-producing levels of infective *Eimeria* will be ingested, it is best to disperse the ewes and their lambs quickly. Corrals and barns used for holding ewes and lambs at weaning should not be used for other purposes. Lambs should be separated and turned to pastures or rangeland and should be carefully watched for the next 3 to 4 weeks. When gathering lambs for finishing in farm flocks, it is best to take delivery at the ranch where they are reared to avoid exposure to coccidia which inevitably occur at sale-yards.

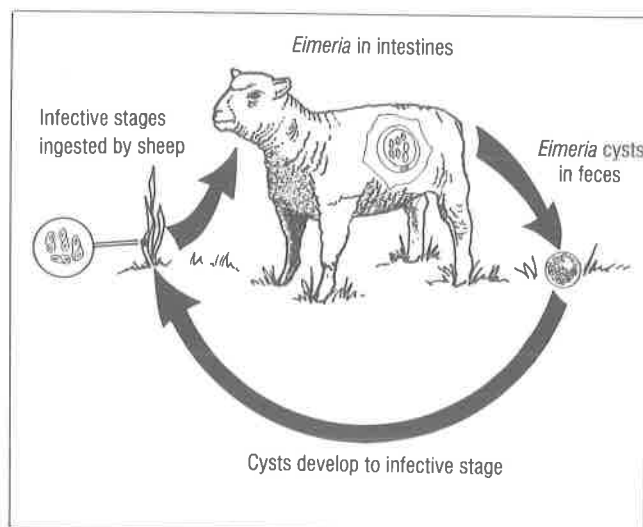

Fig. 23. Life cycle of *Eimeria* in sheep causing coccidiosis.

Despite good management, lambs should be considered highly susceptible upon entry to coccidia-infected environments (pasture, range, farm feedlots). Anticoccidial drugs placed into supplemental feed during the first 4 weeks of initial exposure are effective against the early multiplicative stages of coccidia; however, no drug is presently registered for this purpose in sheep. For treatment of disease-producing levels of coccidia infections in lambs, the sulfonamides are drugs of choice. These and other chemicals, which may receive registration for use in sheep, should be administered in consultation with a veterinarian.

**ROUNDWORMS IN STOMACH AND INTESTINES.** The barber pole or large stomach worm (*Haemonchus*) sucks blood and may produce severe anemia with resultant death of infected sheep. Other nematodes do not suck blood but live on lymph, cellular debris, and gut contents. The most prevalent of these are the middle stomach worm (*Ostertagia*), the black scour worms (*Trichostrongylus*), Cooper's intestinal worm (*Cooperia* species), and the thin-necked worms (*Nematodirus* species) which occur in the first 20 feet of the small intestine, and the nodular worm of the large intestine (*Oesophagostomum* species). Dense worm infestations may cause severe scouring (diarrhea) and ultimate death, especially in lambs and weaners.

The life cycle of these worms is direct (fig. 24), and without involvement of an intermediate host (animals which contain only the young stages of the parasite). Infection is attained by eating infective larvae (young worms) which crawl up on grass in damp situations. Inside the sheep, these larvae enter the mucosal lining of the stomach or gut and become adults. Mating and egg laying continue for several weeks to months if the animals are left untreated. Thousands of eggs are passed daily in the feces onto pasture where, after several days, larvae hatch from the eggs and the cycle is repeated. Worm eggs are resistant to heat, cold, drying, and moisture, and some can persist on pastures for 1 year or longer. In

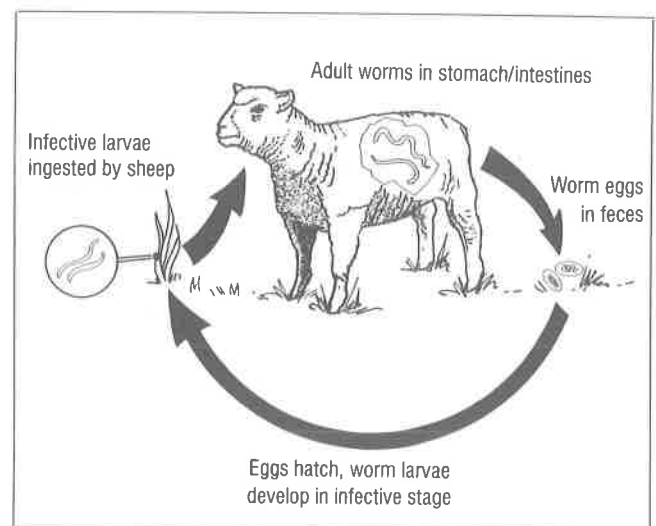

Fig. 24. Life cycle of roundworm in sheep.



some cases the infective larvae may be ingested with water which accumulated from excessive and repeated flood irrigation of pastures and mountain meadows. These larvae are washed from the soil and grass into shallow ponds at unlevelled or pothole areas where sheep drink. If pastures have proper drainage, are allowed to dry out, or if hay is cut and the stubble becomes dry, most — if not all — of the infective larvae will die in 2 to 3 months. Sheep kept under drylot management and dewormed at proper intervals should be less wormy.

**ROUNDWORMS IN LUNGS.** The lungworm, *Dictyocaulus* species, is found in the air tracts of the lungs and in the trachea. Reproduction occurs in these sites where eggs hatch and larvae are coughed up into the mouth and expelled onto the ground, or more commonly, go down the esophagus and pass out with the feces. The cycle on the ground is similar to that of other roundworms, and animals are reinfected by eating grass containing infective worm larvae. Inside sheep, the infective larvae burrow through the gut wall and pass by way of the lymphatic and vascular system through various organs. The larvae change into adult worms upon reaching the lungs. Parasitized sheep cough and have the heaves; weight gains are affected in younger animals. Differential diagnosis from such other disease as pneumonia must be made for proper treatment of the symptoms described. Sheep are more prone to lungworms, when they are ranged on irrigated pastures and mountain meadows, and disease-producing levels of infection are more common from winter through early summer.

**LIVER FLUKES.** These are very common parasites of both sheep and cattle. The adult fluke, *Fasciola hepatica*, lives in the bile ducts of the liver with resultant enlargement and hardening of the duct tissues. Adults feed on bile contents while fluke larvae feed on liver cells and on blood during their passage through the liver tissue to reach the bile ducts. With dense fluke infections the liver does not perform properly and fluky animals are more prone to infectious diseases. Also, young flukes produce conditions in the liver which allow growth of a bacterium responsible for the highly fatal Black Disease; this necessitates annual vaccination of animals ranged in known liver fluke areas.

Adult flukes produce eggs which pass from the bile ducts of the liver into the gut and out with the feces. The so-called ground cycle from here on is unique (fig. 25). A tiny form hatches from the egg and swims around in water until it penetrates a certain type of aquatic snail. These forms are retained inside the snail for almost 2 months where they reproduce in great numbers. Forms which exit from the snails swim in the water briefly before they develop into a protective cyst, either on grass or on the surface of the water. These cysts are ingested by the animal either when it is eating grass or when it is drinking water. Following ingestion, the small flukes emerge from the cysts in the intestines, bore through the gut wall and wander around the abdominal cavity until they come to the liver where they grow to the adult stage.

Liver fluke control should be aimed at breaking the life cycle on pastures. Water control is the first goal. Irrigated pastures should have proper sloping for complete drainage into cross ditches fenced off from sheep. Large potholes should be filled or fenced off. If it is impossible to control the water, arrange for it to collect in deep, plant-free ponds where the sheep are fenced from drinking. Snail control may be feasible by using copper sulfate applied in solution at the rate of 1 part in 1 million parts of water (1 ppm). Applications can be made to stock watering ponds, to marshy areas, or to other closed water systems where drain water is collected in an impoundment area (pond, reservoir) and recycled for additional pasture or crop irrigation. The technique must be done carefully and in proper concentration to avoid fish kill; high concentrations of copper sulfate may even kill livestock.

Use of antiparasitic drugs (dewormers, anthelmintics) against flukes is primarily to reduce death losses due to chronic disease. A new chemical, now registered for use in sheep, is restricted to treatment only by a veterinarian and requires a 180-day withdrawal period from time of treatment to slaughter. Like other chemicals, this new drug is not effective for acute liver fluke disease, and treatment in late spring should be repeated in October or November.

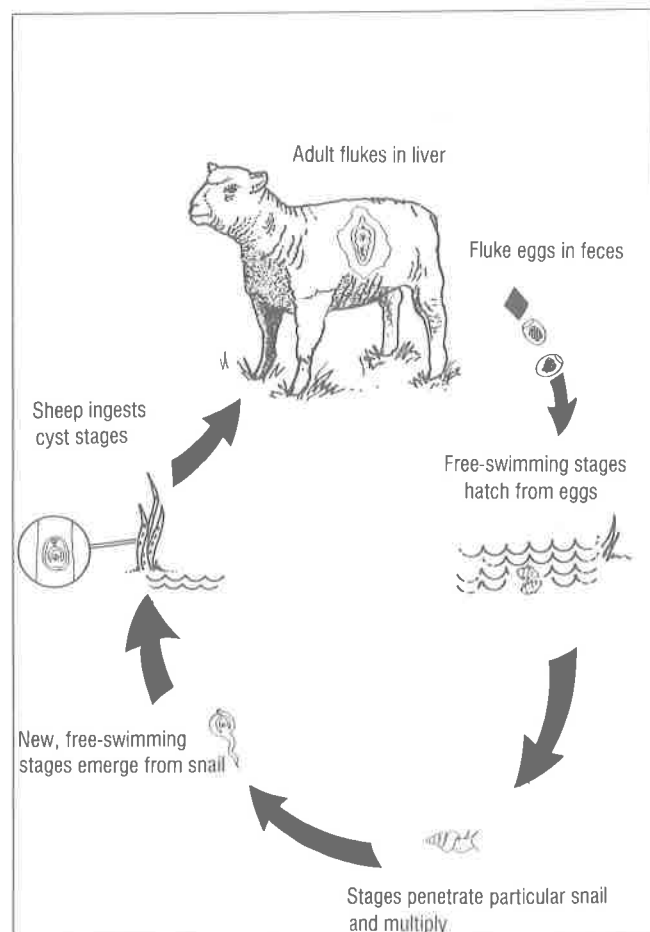

Fig. 25. Life cycle of liver fluke in sheep.

**TAPEWORMS IN INTESTINES.** Tapeworms are cestodes or flatworms, with long, segmented, ribbonlike bodies. Two types common in sheep are the broad tapeworm, *Moniezia*, in the small intestines and the fringed tape, *Thysanosoma*, which lives in the small intestine and in the bile duct leading from the liver to the gut. Like liver flukes, tapeworms utilize an intermediate host (fig. 26) for complete development. Segments measuring from 1/8 to 3/4 inch long break off the body of the tapeworm in the gut and pass out with the feces onto the ground. These segments break open and release hundreds of eggs which are ingested by mites that live in the pasture grasses. Sheep are infected when they feed on the forage and ingest the mites; the closer they feed, the greater the opportunity to also take in the mites containing infective forms of the tapeworm. Immature tapeworms are released from the mite in the intestines and quickly attach to the gut wall where they develop into adult worms. Tapeworms do not usually cause noticeable symptoms of disease, but can — in dense numbers — cause blockage of the gut or bile duct. These latter conditions may occur in young lambs since there is an age or acquired form of immunity which develops in animals over 1 year old.

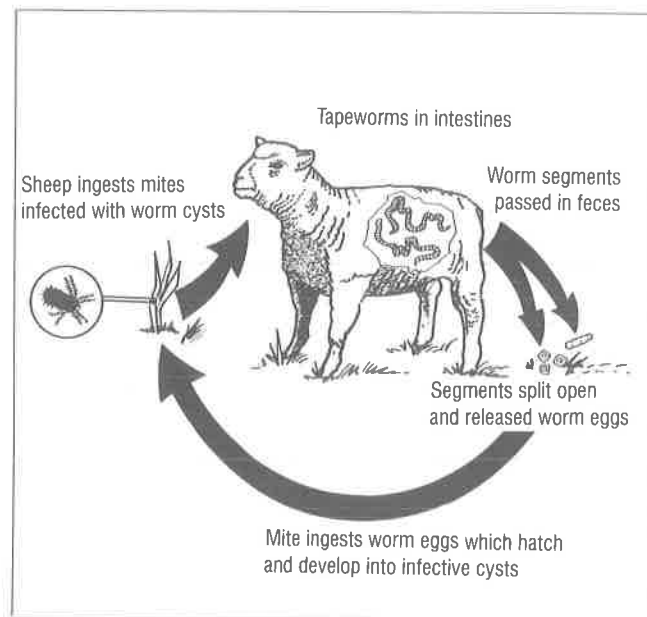

Fig. 26. Life cycle of tapeworms in sheep.

## WOOL

The value of wool, an important product of the sheep industry, is derived from its many uses. How it is used depends on the diameter of the wool fiber or grade. Finer wools are used for worsted clothing, medium fine wools are used for woolen clothing, and coarse wools are used for carpeting.

### Grades

Wool's value is determined, in part, by its grade. Three grading systems are used in the United States, the most common is the English or Bradford system (count grades), which is based on the number of hanks of yarn that can be spun from 1 pound of scoured and clean wool. The finer the wool, the more hanks can be spun from a pound of wool. The finest wool is 80's and the coarsest is 36's (fig. 27).

The American or blood system (blood grades) developed with the early sheep industry. It is based on the amount of blood dilution that occurred when the introduced fine wool breeds were mated to the sheep used in the early sheep industry. Most of the early sheep had poor wool production that was of poor quality.

The third system is new (micron grades). It is based on measuring the diameter of the individual wool fibers. These mea-

surements are expressed in microns. This is the most accurate of the systems. Also, this system can indicate the amount of variation in the fleece.

Figure 27 shows the three systems and the breeds of sheep that produce the various grades of wool. This should give you a general idea of the grade of wool your sheep will produce.

Good quality wool of all grades is in demand. Many factors, other than grade or fineness of the wool fiber, influence the price received. These factors include: the amount of foreign material in the wool, the color of the wool, its uniformity, length, and how it is prepared for market.

### Factors Reducing Wool Value

**Foreign materials.** The amount and kind of foreign materials in the wool determines how much the price is discounted or docked. The harder it is to remove foreign material, the lower the price. Plant matter, like hay and straw, can be removed more easily than can burs. Manure leaves green stains on wool. Sand or dirt usually can be shaken out of wool during processing, but vegetable or plant material is more difficult to remove during processing.

	Delaine Merino													
	Rambouillet													
				Targhee										
				Romeldale										
				Columbia										
				Southdown										
							Shropshire							
							Suffolk							
							Hampshire							
							Dorset Horn							
							Montadale							
							Finnish Landrace							
							Cheviot							
							Corriedale							
										Oxford				
										Romney				
										Border Leicester				
													Lincoln	
													Cotswold	
Count Grades	80's	70's	64's	62's	60's	58's	56's	54's	50's	48's	46's	44's	40's	36's
Micron Grades	17.70 to 19.14	19.15 to 20.59	20.60 to 22.04	22.05 to 23.49	23.50 to 24.94	24.95 to 26.39	26.40 to 27.84	27.85 to 29.29	29.30 to 30.99	31.00 to 32.69	32.70 to 34.39	34.40 to 36.19	36.20 to 38.09	38.10 to 40.20
Blood Grades	Fine			Half Blood		Three-Eighths		Quarter Blood			Low Quarter	Common	Braid	

Fig. 27. Grades of wool from the finest (80's) to the coarsest (36's) as produced by sheep common in the United States. *Count grade* is based on the number of hanks of yarn spun from 1 pound of clean wool; *Micron grade* is determined by measuring in microns the diameter of individual wool fibers; *Blood grade* is based on the quality of wool resulting from mating fine wool breeds with common or coarse wool breeds.

**Plastic or plastic fibers.** Plastic baling twine is almost impossible to remove from wool during processing. The plastic usually ends up on the woven cloth. The cloth has to be destroyed or the plastic must be removed by hand, a very expensive operation. Most wool buyers will not take wool that is contaminated with plastic. *Make sure plastic does not come in contact with your fleeces.*

**Stains.** Wool stained or discolored by wet manure or urine is less valuable than clean, white wool. Wet manure will stain wool a light green; urine will turn wool off-white or light yellow. Wool that is sacked or stored too wet will turn off-white.

**Other factors.** The characteristics of the wool fibers themselves can influence the value of the fleece. Tender wool is of less value than good, strong wool. Where the break occurs along the wool fiber also will influence fleece value. Fleeces with breaks in the middle of the fiber are of less value than those with breaks near the ends of the fibers. Wool from sheep fed sulfur-deficient diets will have little crimps and will be of less value.

## Wool Management

Now that we know what reduces the value of wool, what can be done to maintain the quality of wool a healthy sheep produced? Conditions that reduce the price for wool can be corrected with good management at shearing.

**Shearing area.** Most people raising small numbers of sheep shear them where it is convenient. The shearing area should be free of the hay, straw, and manure that sheep track in and should be kept clean. A concrete floor is easy to keep clean, but many shearers do not like to shear on concrete because of the danger of breaking equipment.

One or two sheets of plywood makes an area large enough for shearing. The wood should not be slick because the sheep and the shearer will have a hard time standing. Provide your own plywood rather than using that of your shearer to prevent spread of disease, particularly boils. Demand that the shearer disinfect the shears before shearing your sheep. Have disinfectant ready.

**Tying fleece.** Once the fleece is off the sheep, it should be spread out on a clean area, flesh side down, for inspection. Wool containing manure or stained by urine should be removed from the fleece. Any other foreign material also should be removed.

Now the fleece is ready to be tied. First fold the legs and head area in toward the center to make fleece into rectangular shape. Then roll the fleece, beginning at the rear, toward the front so that the shoulder wool will be on the outside. Use *wool ties made of paper* to tie the fleece. If paper wool ties are not available, do not tie the fleece. **DO NOT use plastic or hemp twine.** Wrap the tie around the fleece, then cross the twine and wrap in the other direction. Pull the tie reasonably tight and tie the twine with a knot that will not slip. The task of tying is then completed.

This simple management practice will reduce the hay, straw, and manure contamination of the fleeces.

**Prevent plant material contamination.** Feeding hay in poorly designed feeders or poor feeding practices will increase the hay contamination of the clip. Feeders with rub poles or bars that are too low will force hay into the wool on the top of the sheep's neck. This problem can be corrected by adjusting rub poles or using a feeder of a different design. (See section on feeder plans.) Feeding hay on the ground can contaminate wool if it is thrown on the backs of the sheep. The hay leaves become entangled in the wool.

Burs also contaminate wool. Buyers usually dock the price of wool severely when there are many burs. A good weed control program around corrals and pasture will correct this problem.

**Reduce wool stains.** Tagging sheep in the fall will reduce the amount of manure and urine stain in the wool. Sheep also should be tagged before lush green grass is available. The lush green grass usually causes the sheeps' manure to become wet and very soft, thereby staining the wool around the rectum and between the hind legs.

**Prevent plastic contamination.** Plastic from baling twine or other sources can get into the wool in many ways. One common way is when the plastic twine used to tie corral gates and other sheep equipment becomes frayed. The small plastic fibers become entangled in the wool as the sheep brush the gates and equipment.

Plastic twine left on the ground and worked into the soil is picked up in the wool when the sheep bed on this soil. Even a small amount of plastic can reduce the value of the clip. Also, sheep grazing hay fields that have been baled with plastic twine can pick up plastic in their wool from twine that is left in the field.

**Branding paint contamination.** Wool price-dock from branding paint usually is not a problem with small sheep producers. If sheep are branded, use only scourable branding paint; road tar and oil should not be used as a paint because they cannot be removed.

**Black wool contamination.** Black wool mixed with white wool will reduce the value of a clip. Black sheep or white sheep with a lot of black wool fibers should be separated from the other sheep before shearing. All white sheep should be sheared first; sheep with black wool fiber should be sheared last. If black sheep are sheared first, the black fibers will get on the shearing area and fleeces from the next several sheep will become contaminated with black wool fibers.

**Feed affects wool.** The amount and kind of feed a sheep eats can influence the value of the wool. Sheep fed an adequate amount of a high quality feed will produce large, strong wool fiber, which means more wool per sheep; however, if sheep are short fed (not given enough feed), the wool fibers will be smaller in diameter and not as strong. Breaks in the wool are present if the diet is extremely low in protein, and the wool can have a break (weak area) if sheep are fed well and then starved. Where the break occurs in the wool corresponds to when the sheep were short fed. High fever also will produce wool breaks or weakness.

Sheep on a low plane of nutrition will produce low value wool. The wool will not have the normal amount of crimp and will appear coarse and brittle. Cloth made from this wool will not have the soft and resilient properties of wool.

The problem of wool value related to nutrition can be corrected by a good nutrition program. Make sure the sheep have an adequate diet at all times. This does not mean the sheep have to be fed so much feed that they become too fat.

## Packaging Wool

Preparing an attractive wool clip will influence the price received. Good packaging of wool will indicate your interest in marketing a good product; wool buyers recognize good packaging and will pay for it. Wool should be packed in wool sacks, *never* in plastic feed sacks. Burlap or cotton feed sacks can be used. Sacks should be tied (closed) with cotton or linen string, not plastic twine; packed as tightly as possible and labeled as to the type of wool.

Wool should be sacked according to color. All clean, white wool should be packed in one sack, all black wool in another, and white wool with black fibers in a third sack. Crutching and tags should be sacked separately. Some buyers of small lots of wool will look at the tags to get an idea of how well the clip has been prepared. Store the wool in a clean, dry place, away from rain, dew, mud, dirt, hay, straw, and rodents; protect its value.

## Sheep Management Before Shearing

Sheep should be dry for shearing. Even after a light rain or a heavy dew wool will be too wet to package and store and it will turn yellow in the sack and mold or mildew. These stains cannot be removed in the scouring process. On the other hand, a couple of hours of sunshine or a light wind will dry wool on the sheep.

Take sheep off feed and water at least 12 hours before shearing to reduce chances of injury or death while they are being sheared. A full stomach puts pressure on such internal organs as the heart, lungs, and liver; additional pressure from shearing on these organs can cause death. Even if the sheep do not die, they will be very uncomfortable and will move a lot during shearing. The more the sheep move, the greater the chances they will be cut, and it will take longer to shear them. Full sheep do not work through the shearing corral very easily and because they are full, the shearer will have more weight to handle.

## Shearing Time

Most sheep are sheared in the spring after lambing and when the weather is warm. They are easier to shear in warm weather when the yolk is soft and serves as a lubricant during shearing. In cold weather the yolk becomes gummy and the shears become coated with yolk and dirt, making it hard to push the shears through the wool.

Ewes can be sheared before lambing, but care in handling the ewes is necessary to prevent abortions. Sheep should have protection from the weather for 2 or 3 days after shearing while they adjust to their new environment. Another practice that will help them adjust after early shearing is shearing with a rake comb, which leaves about 1/4 inch of wool on the sheep - enough to provide protection from the weather. Rake comb shearing requires greater skill because the teeth of the comb are wider than in normal combs, thus increasing the chances of cutting the sheep.

# FENCING FOR SHEEP

Fencing, important in producing and managing sheep, serves two basic purposes: (1) to confine sheep to the area(s) in which you wish to have them remain; (2) to deter domestic dogs and other predators. In addition, fencing pasture and rangeland can:

- Eliminate or reduce the need for herders.
- May increase grazing capacity of land.
- Permit rotational and deferred grazing so pasture can be rested.
- Permit segregation of classes and kinds of livestock.
- Control straying and trespassing.
- Permit seasonal control of hazardous areas such as bogs or poisonous plants.
- Protect new seedlings until they are established.

There are several different kinds of fencing: woven wire, board, electric, or a combination of these. Barbed wire is not recommended for sheep because the animals are prone to injury when they come in contact with this kind of fencing. The barbs have a tendency to pull the fleece on sheep. Predator control is not as efficient with this type of fencing.

Board fences, using 1 inch by 6 inch or 2 inch by 6 inch lumber, are excellent. Costs of construction can be high, however. Horizontal spacing between boards must be narrow to prevent sheep from getting out. Four-inch spacing on the bottom boards is ideal. Spacing can then be increased

slightly with successive boards until spacing is 6 to 8 inches with top boards.

Lumber used for fences and gates should be treated with a recommended wood preservative (creosote, for example) or be commercially pressure-treated. Fences built with treated lumber will last longer and the annual cost will be lower. Board fence alone is not a good predator prevention safeguard; however, woven wire added to board fence will be excellent in this regard, although costly. Adding woven wire to a board fence already in existence will make an excellent sheep-tight fence that should reduce predator problems.

Woven wire field fencing, widely used to contain sheep, makes excellent fencing when properly installed. Ideally, 47-inch-high field fencing with 6-inch stays is the best woven wire to use. It is tall enough to restrict "jumpers," and the height and wire spacing reduce chances of entrance by domestic dogs. Running a strand of electric fencing along the top wire of the field fence and along the bottom of the fence will make it more sheep-tight and predator-proof.

Electric fencing, widely and successfully used throughout farming areas where livestock is raised, is an effective, safe, and inexpensive means of providing temporary, permanent, or moveable fencing, if the fences are properly constructed and if they are energized with an approved controller. (A controller is commonly called a charge or a fence charger.)

In recent years electric fencing has undergone much development, particularly in New Zealand and the United Kingdom. Its rising popularity is due not only to its notorious cheapness, but also to its effectiveness. Development of the High Powered-Low Impedance Energizer in New Zealand is very attractive. In contrast, American manufactured controllers are so-called high impedance controllers, which are more apt to short-out when weeds or long grass come in contact with the fence. The low impedance energizer reduces this short-out problem, plus 60 miles of fence wire can now be electrified with little voltage loss. Even when plant growth covers much of the fence, the low impedance energizer is relatively unaffected.

The electric fence in modern form is certainly a "mental barrier" type of fence, providing an excellent method of stopping animals from getting out and predacious animals from getting in. Recommended wire is smooth, galvanized, high-tensile steel of 12.5 gauge with 200-pound tension strength.

Predator-reducing fences, using electric wire, can be designed in many ways. A top strand and bottom strand of wire can be used on an existing woven wire or board fence.

These wires are set a few inches away from the existing fence, either inside or outside. (Apply to the inside of your fence, if the fence line has much chance of people contact.) Running additional strands will improve predator control. A 12-wire fence developed at the U.S. Sheep Experiment Station in DuBois, Idaho, effectively controls coyotes.

**ELECTRIC FENCE** or **DANGER** signs are recommended each 100 yards (check local ordinances).

To make predators fear your electric fence, make the fence half electric. If your fence is all electric — that is, if all the wires are charged — the predator won't necessarily get shocked each time contact is made. But on an alternating basis, if one-half of the wires are charged and the other half are grounded, the predator will be stung each time it touches the fence.

Sheep also may need training regarding the electric fence. One way to do this is to expose them to the fence soon after shearing when they are more likely to be shocked by the touch than when they are in full fleece.

## MARKETING

---

The marketing of sheep and wool can be a problem for most small producers. There are not many options open for the sale of products. The following is a list of possible ways the live sheep could be sold.

- Sell live sheep by word-of-mouth.
- Sell through auction yard.
- Advertise in newspapers and trade magazines.
- Sell to commercial sheep slaughtering plants.
- Sell ewe lambs to other producers.
- Top quality lambs could be sold as club lambs (4-H and FFA).

These options are limited to the number of animals that can be sold or limited to the availability of commercial sales outlets. The marketing opportunities may limit the number of sheep a person should sell.

The options for selling wool are not very numerous; however, the following is a list of potential outlets:

- home spinners (most want colored fleeces),
- commercial wool buyers,
- local wool buyers (this price usually is quite low), or
- a few top fleeces at fair wool sales (if available).

The specialized market of home spinners requires a particular type of wool. The breed of sheep that produces these specialized wools are not always ones that produce the best market lambs.

Wool and lamb pools, computer or tele-auctions could improve marketing conditions, but at this time only a limited number of small pools and no computer or tele-auctions are in operation in California.

# APPENDIX A

## Sheep Equipment

Well designed corrals, barns and equipment are a must if sheep are to be handled with minimum stress. Give considerable thought and planning before you build your sheep facility.

First, evaluate the space you have. Use it efficiently with your equipment. Locate barns, corrals, and feeders so they are compatible with each other and the animals can move through them easily. Animals do not like blind spots, sharp corners, or dead ends. Also, locate barns and corrals so they won't flood in wet weather.

Next, evaluate talent, time, and economic resources. Do you

want to buy most or all of the equipment, or do you want to build it yourself? There is a lot of well designed and well constructed commercial sheep equipment available that will meet the needs of most sheep producers. The question is, can you justify the investment? The alternative is to build the equipment yourself. Most Cooperative Extension offices have access to building plans for most types of equipment. Blueprints can be picked up for a minimal cost.

The following are some plans taken from a Kansas State University bulletin entitled, *Sheep Handbook — Housing and Equipment*, that may be helpful in designing a sheep facility.

### A-1 Barn Designs

Thirty ewes, inside feeding.  
Movable pens, creeps, and feeder permit flexible space use.

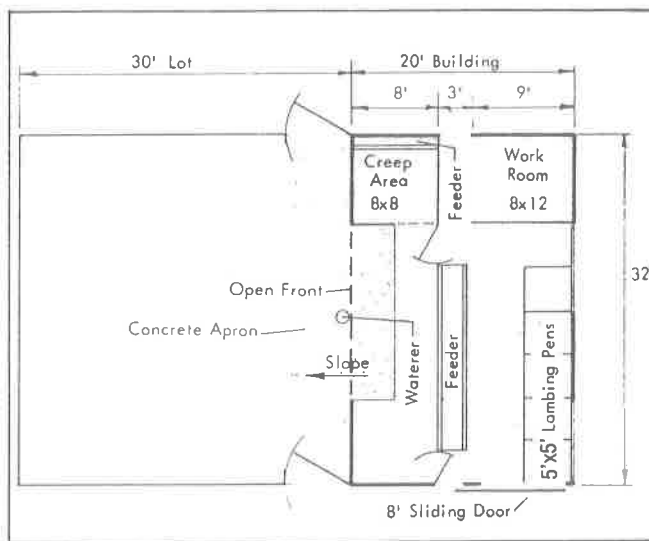

### A-2 Lambing Jalls

(Midwest Plan Service)

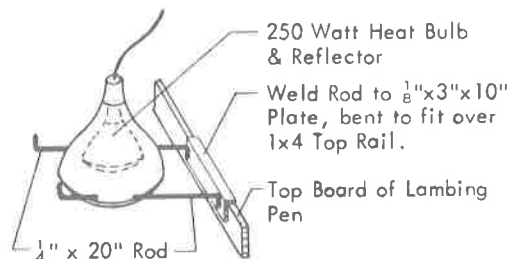

#### Recommendations:

1. 1750 watts maximum load per circuit (check state code).
2. Metal reflector.
3. Cord should not reach the floor from outlet.

#### Brooder Lamp Supports

Use heat lamps only to dry off lambs (about 1/2 hour) in extremely cold weather.

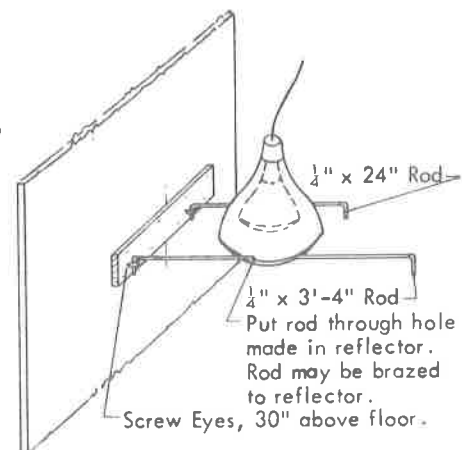

### A-2 Lambing Jails (continued)

(Midwest Plan Service)

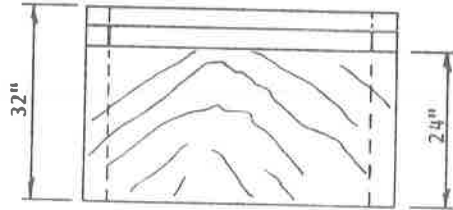

Panel Construction So Ewe Can See Through

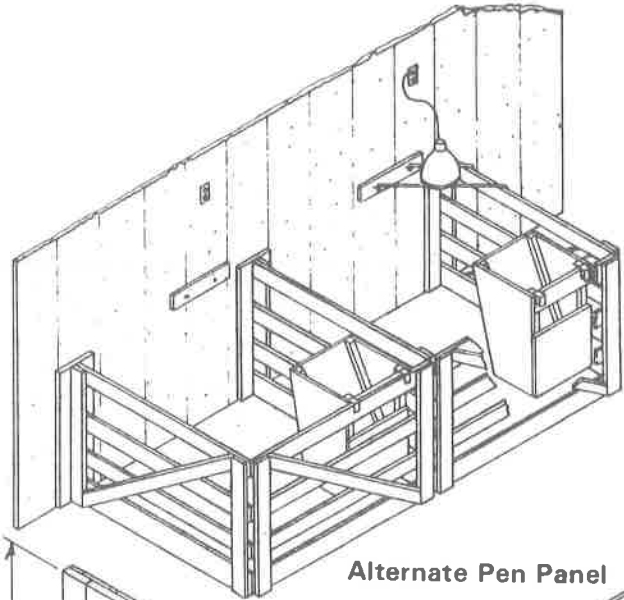

Alternate Pen Panel

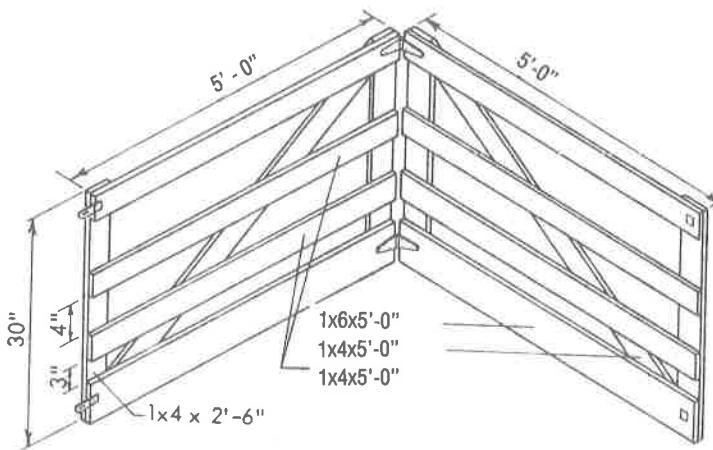

Lambing Pen Panel

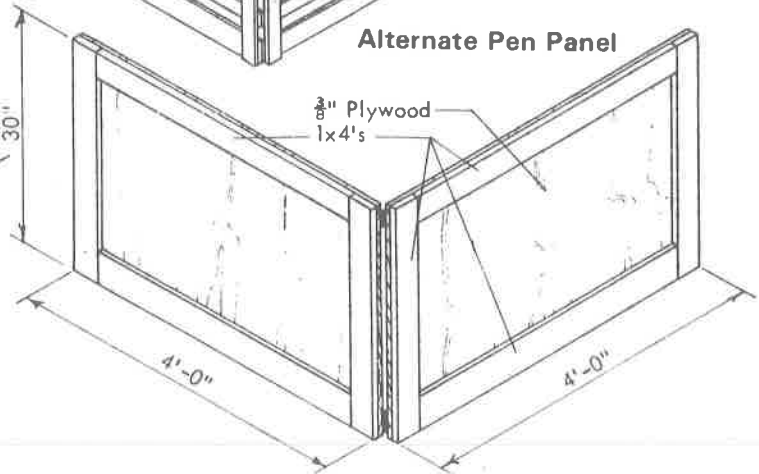

### A-3 Ewe Hay Rack for Lambing Jails

(Midwest Plan Service)

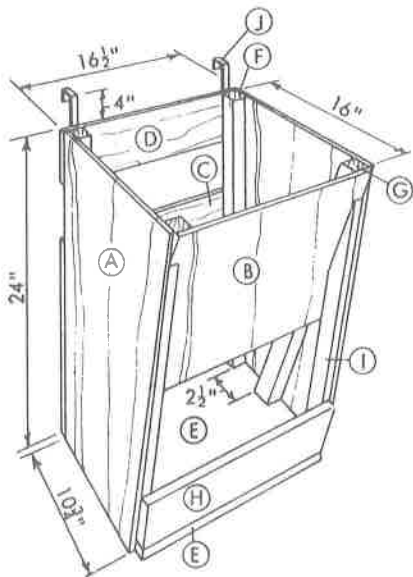

CUTTING LIST		
Item No.	Description	
A-D	see plywood cutting diagram	
E	1	1x12 x 16"
F	2	2x2 x 24"
G	2	2x2 x 26-1/2"
H	1	1x4 x 16"
I	2	1x2 x 24"
J	2	1/8" x 1" x 12" strap

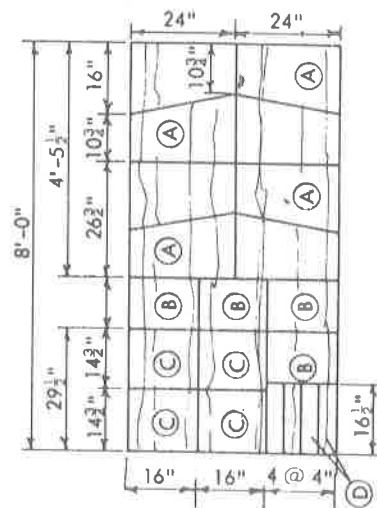

Cutting Diagram For 4 Racks  
1/4" Plywood Or Pressed Wood



**A-3 Ewe Hay Rack**  
(Midwest Plan Service)

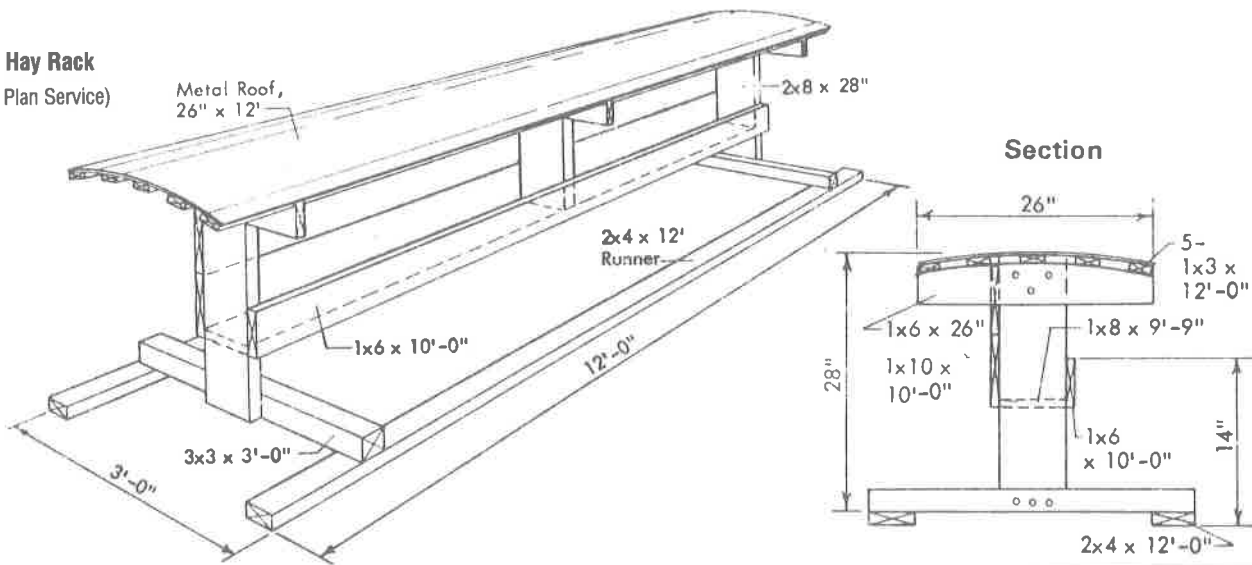

**A-4 Hay and Grain Feeders**  
(Midwest Plan Service)

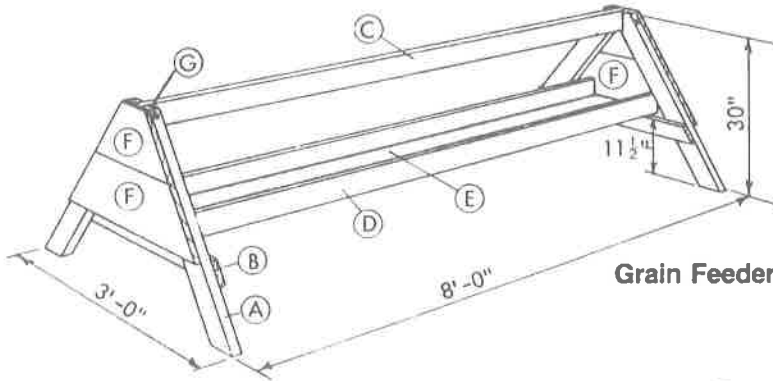

**CUTTING LIST**

Item	No.	Description
A	4	2x4 x 3'-0"
B	2	1x4 x 28"
C	1	2x4 x 8'-0"
D	2	1x4 x 8'-0"
E	1	1x10 x 8'-0"
F	1	1x10 x 6'-0"
G	2	3/8" x 7" bolt

**Grain Feeder for Ewes or Lambs**

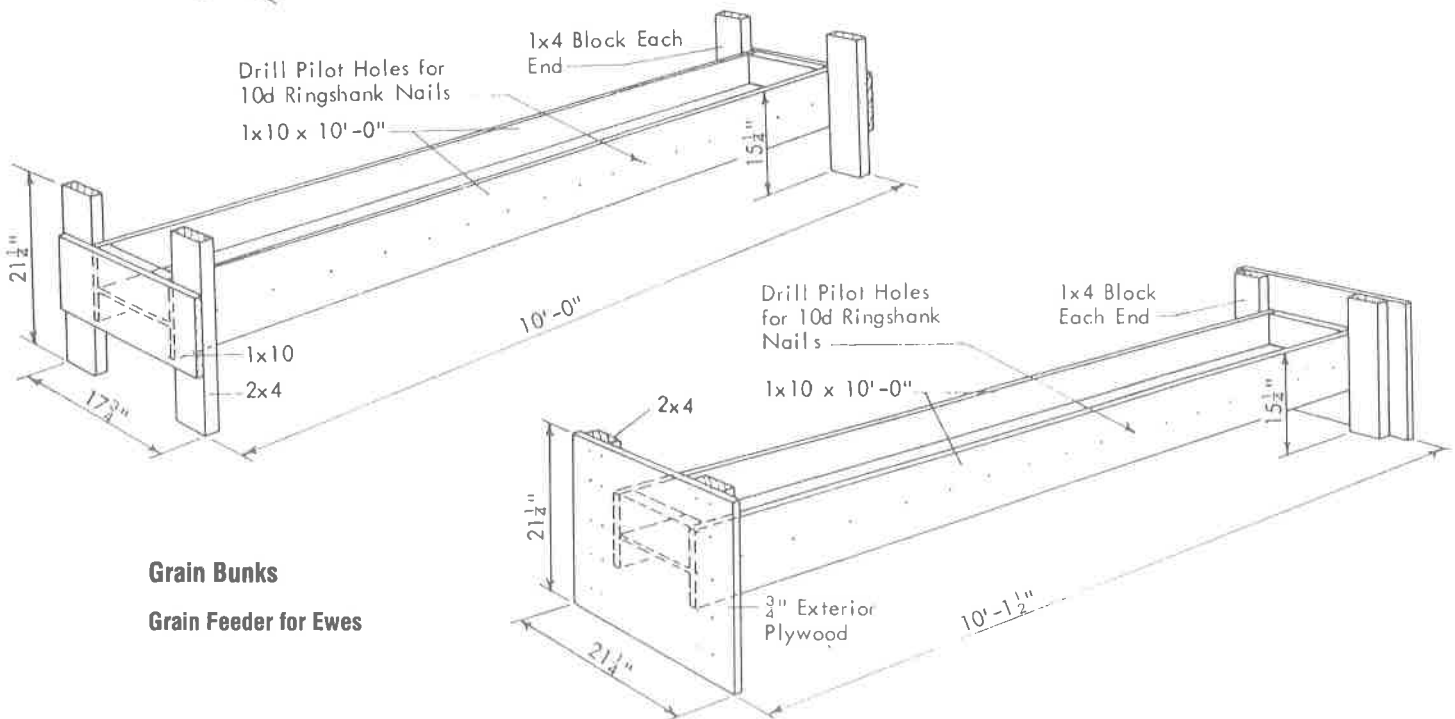

**Grain Bunks**  
**Grain Feeder for Ewes**

**A-4 Hay and Grain Feeders (continued)**

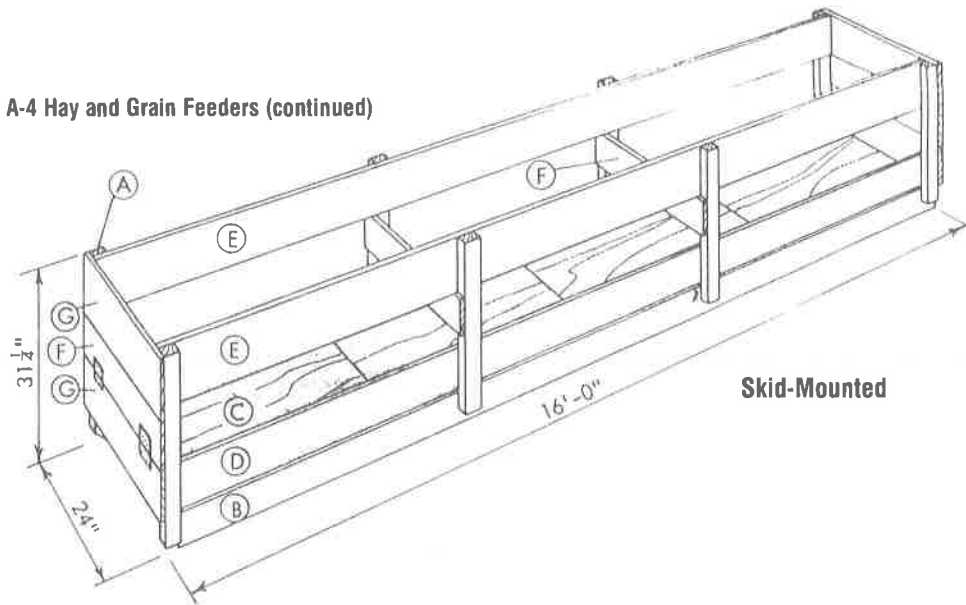

**Cutting List**

Item	No.	Description
A	3	2x4 x 30"
B	2	2x6 x 16'0"
C	4	24" x 48" lengths 3/8" C-C ext. plywood
D	2	1x8 x 16'0"
E	2	1x10 x 16'0"
F	4	1x8 x 25 1/2"
G	4	1x10 x 25 1/2"
H	2	1x6 x 16'0"
I	4	3" butt hinges

Skids Pressure Treated

**A-5 Salt and Mineral Boxes**

(Midwest Plan Service)

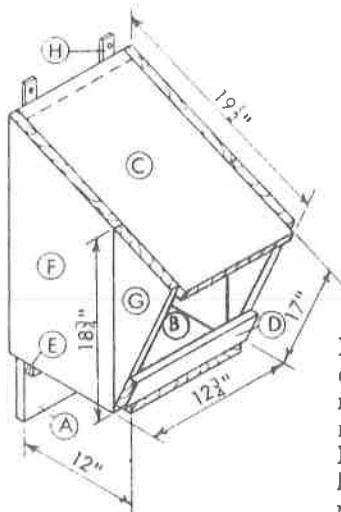

**Cutting List**

Item	No.	Description
A	1	1x12 x 30"
B	1	1x12 x 12"
C	1	1x12 x 19 1/2"
D	1	1x4 x 12 3/4"
E	1	1x1 x 12 3/4"
F	2	1x8 x 18"
G	2	1x8 x 18"
H	2	1/4" x 1 1/4" x 6" strap

For outside use cover roof with metal or roll roofing. Nail to wall or hang on fence panel.

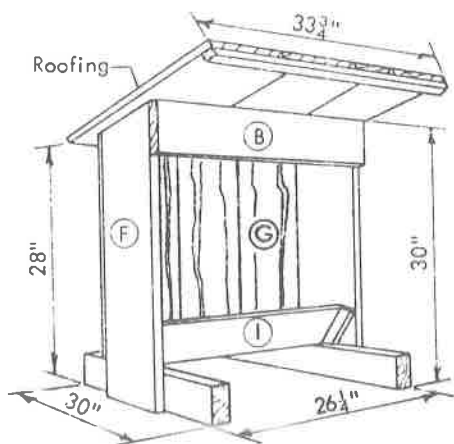
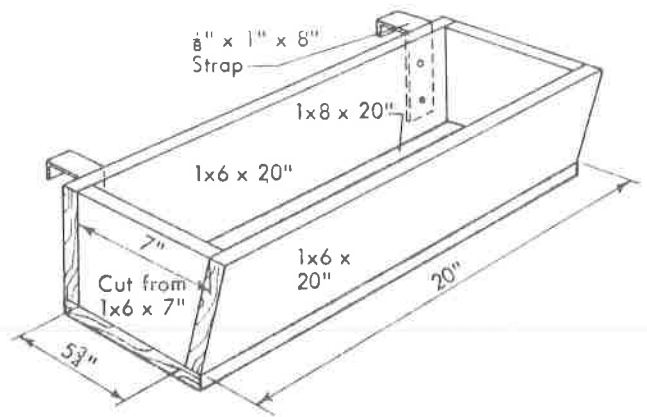

**Cutting List**

Item	No.	Description
A	2	2x4 x 30"
B	1	1x6 x 27 3/4"
C	2	1x1 x 4"
D	1	2x2 x 26 1/4"
E	1	2x8 x 26 1/2"
F	2	1x12 x 30"
G	3	1x10 x 24"
H	3	1x12 x 28"
I	1	1x6 x 26 1/4"
J	1	1x2 x 33 3/4"

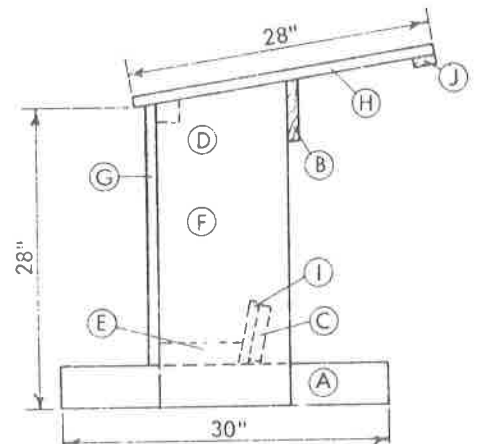

**Side Elevation**

## APPENDIX B

### General Tips on Feeding, Facilities and Management for Sheep

#### Growing and fattening lambs (feed and water)

- Provide a minimum of 8 linear inches of feeder space per head for hand-feeding roughage or concentrate.
- When grain or concentrates are self-fed, allow 3 inches of linear feeder space per head.
- When feeding a complete ration, allow 4 inches of linear feeder space.
- Sheep need clean water—free choice is best. (Sheep will need a minimum of 2 to 3 gallons per head per day, depending on body size and climate.)
- Provide watering space as follows:  
Open tank or trough — 1 linear foot per 20 heads.  
Automatic bowl — 1 per 30 heads.

#### General management

- Provide economical housing for lambs. Open shed or windbreaks may be adequate in mild climates. In open sheds, provide at least 6 square feet per head.
- Provide minimum lot space as follows:  
All dirt — 20 square feet per head.  
Paved — 12 square feet per head.
- Build hard-surfaced lots with a slope of 1/4 to 1/2 inch per foot. In dirt lots, provide 1/2 inch or more slope per foot, depending on soil and weather conditions.

- Provide a minimum paved area of at least 5 feet around water troughs, feed bunks, roughage racks, and shed entrances.
- Provide artificial shade, unless sheep have access to natural shade. Allow 6 to 8 square feet per head. Build shade 8 to 10 feet in height.

#### Breeding sheep

- Provide a minimum of 1 linear foot of feeder space per head for hand-feeding roughage or concentrate.
- When grain or concentrate are self-fed, allow 6 linear inches feeder space per ewe. If salt or other feed intake inhibitors are used, less space may be needed. Provide a minimum of 6 linear inches of roughage rack space per ewe for self-feeding hay or silage.
- Provide at least 2 to 3 gallons of clean water per ewe per day.
- Provide watering space as follows: 1 linear foot of open tank per each 20 heads, or one automatic bowl per 30 heads.
- Provide a minimum of 16 square feet of space for lamb and ewe during lambing.

1 Excerpted from *Digestive Physiology and Nutrition of Ruminants*, 1972, D. C. Church.

## APPENDIX C

### Foot Rot Eradication

The following items are necessary for an effective eradication program:

- A) hoof trimmers (or a sharp pocket knife);
- B) two foot troughs: 12 feet long, 12 inches wide, 6 inches deep; fiberglass, concrete, or wood;
- C) chemicals (note: all are toxic; do not let sheep drink them):
  - 1) 10 percent formalin (5 percent solution has proven to be effective)  
2 gallons of formalin to 18 gallons of water  
(gives off harmful fumes; use only in well ventilated areas)
  - 2) 20 percent copper sulfate  
32 pounds to 20 gallons of water  
(stains the wool)
  - 3) 10 percent zinc sulfate  
16 pounds zinc sulfate to 20 gallons of water  
(solution has been reported to be as effective as copper sulfate; does not stain wool)
- D) three separate pens or pastures (for unaffected, healing, and infected sheep).

Every hoof of every sheep must be inspected and trimmed and every animal must go through the foot troughs. The first foot trough contains water to clean the feet. The second foot trough contains either of the chemicals. The sheep should stand in the chemical for several minutes. Unaffected animals should be placed in a pen or on a pasture that has not had sheep in it for at least 3 weeks. Severely affected animals with deformed feet should be culled immediately. These animals will never be completely cured and will be a constant source of infection for clean animals. When an infected hoof is found, all the decaying hoof surfaces must be trimmed away until only uninfected tissue is left. If this is not done, the chemicals in the foot bath will not be able to reach residual organisms.

Infected animals need to be kept separate and should be run through the foot trough every other day for a week. At the end of a week their hooves should be reinspected and retrimmed. Animals that appear healed should be placed in a convalescent pen. Infected animals should be given another week of the original treatment. After several cycles of this, only chronically infected animals will be left in the infected group. These animals should be culled. Animals in the con-

valescent group should be examined and run through the foot troughs before finally being mixed with the unaffected animals. On an individual animal basis, the administration of antibiotics seems to hasten recovery from foot rot; however, inspection, trimming, and foot trough utilization are still important.

Once foot rot is eradicated from a flock, it is a must to inspect, trim hooves, and run through the foot troughs all animals brought into the flock. These animals should be kept separate for 2 weeks and then reexamined before mixing with other animals. Every animal should be inspected, trimmed, and run through the foot troughs at least twice a year. Lameness should be inspected immediately, and if foot rot is found, the entire eradication program should be repeated. There are several treatment schedules for eradicating foot rot.

#### **Foot rot two-week program — Day 1**

- Examine all the feet of all the sheep.
- Trim the hooves very close. Do not draw blood on healthy feet, but make sure there are no pockets of dirt or manure left on the bottom of the foot.
- Trim infected hooves closer. Make sure all infected hoof tissue is exposed. This may require cutting away healthy hoof to expose the infected area.
- Hand treat the infected hoof with one of the disinfectant solutions listed at the beginning of this appendix.
- Sort the flock into two groups — a healthy (clean) group and an infected group. This should be done as the feet are trimmed. After trimming do not allow healthy and infected sheep together.
- Put the clean group through the footbath.
- Isolate clean sheep on clean ground that has been free from all sheep for at least 3 weeks.
- Put the infected group through footbath.
- Hold infected sheep for further treatment. Put these sheep on clean ground, if possible.

#### **During first week**

- Walk infected sheep through footbath every other day.

#### **End of first week**

- Reexamine all sheep in infected group.
- Retrim hooves of all infected sheep. Make sure infected tissue is exposed. This may require extensive trimming of the infected feet.
- Hand treat the feet that have been trimmed with disinfectant solution.
- Walk all infected sheep through footbath.
- Establish a third group that appears to be healed. Keep this group isolated on clean ground.
- Hold infected sheep for further treatment.

#### **During second week**

- Walk infected sheep through footbath every other day.

#### **End of second week**

- Reexamine all the feet of all the sheep.
- Walk clean and healed sheep, separately, through footbath and return them to clean ground.
- Retrim hooves of infected sheep, if necessary.
- Move healed sheep from infected group to healed group.
- Slaughter sheep that still have severely infected feet and sheep with twisted or distorted feet. *Do not sell your problems to someone else.*

#### **Foot rot prevention**

Now that your flock is free of foot rot or if it was already clean, set up a prevention program. The prevention program should include:

- Keep your clean sheep away from known sources of foot rot.
- Do not let clean sheep walk on recently contaminated soil (2 weeks).
- Keep sheep away from wet and muddy areas if possible.
- Check every foot of every sheep in your flock for foot rot twice a year. Trim the hooves as needed. In some areas hooves may need to be trimmed more than twice a year. After the hooves are trimmed, walk sheep through footbaths. If you find foot rot, begin an eradication program immediately.
- Watch for lame sheep and treat at once.
- If possible, buy sheep from flocks that have been clean for at least 6 months.
- Make sure that every new sheep is free of foot rot before entering your flock. Trim the hooves of new sheep, hand treat all feet and isolate the new sheep for 2 weeks. After 2 weeks, reexamine all the feet of the new sheep. If the sheep are clean, move them into your flock.
- Keep pastures and lots free of sharp objects, broken equipment, and trash that could cause injuries.

#### **Foot rot control alternatives for very small flocks**

1. Isolate all sheep with foot rot.
2. Trim hooves as indicated under foot rot prevention.
3. Treat newly trimmed hooves with commercially available solutions. (Kopertox, "Foot Rot Liquid")
4. Cover trimmed and treated hoof with an old sock. Secure with string or rubber band—not too tight (no holes).
5. Place in clean pasture or pen (no sheep for previous 14 or more days).
6. Re-treat at least weekly until healed.
7. Keep isolated for 2 to 3 weeks after feet are healed before returning to flock.

The recommended eradication program was taken in part from USDA Farmer's Bulletin 2206 entitled *Foot rot in Sheep*. (This publication is not listed in the 1983 USDA Publications Catalog.)

# APPENDIX D

---

## References

### Books

- Collins, S. B.** 1966. *Profitable Sheep*. San Luis Obispo: n.p.
- Cooper, M. McG., and R. J. Thomas.** 1976. *Profitable Sheep Farming*. London: Farming Press.
- Ensnuger, M. E.** 1970. *Sheep and Wool Science*. Danville, IL: The Interstate.
- Fell, H.** n.d. *Intensive Sheep Management*. London: Farming Press.
- Jensen, R.** 1974. *Diseases of Sheep*. Philadelphia: Lea & Febiger.
- Jones, G.** n.d. *Sheep Breeds Index*. Hays, KA: Northridge Communications.
- Juerginson, E. M.** 1981. *Approved Practices in Sheep Production*. Danville, IL: The Interstate.
- The Management and Diseases of Sheep*. 1979. Edited by the British Council. London: British Council and Commonwealth Agriculture Bureaux.
- Owen, J.** 1979. *Complete Diets for Cattle and Sheep*. London: Farming Press.
- Parker, R.** 1983. *The Sheep Book*. Boston: Charles Scribners and Sons.
- Patton, W. R., D. W. Cassard, and E. M. Juerginson.** 1977. *Approved Practices in Feeds and Feeding*. Danville, IL: The Interstate.
- Scott, G. E.** 1970. *SID The Sheepman's Production Handbook*. 2nd ed. Denver: Sheep Industry Development Program.
- Simmons, P.** 1979. *Raising Sheep the Modern Way*. Charlotte, VT: Garden Way Publishing.
- Speedy, A. W.** 1980. *Sheep Production - Science into Practice*. London: Longman.
- Tomes, G. J., D. E. Robertson, and R. J. Lightfoot.** 1979. *Sheep Breeding*. 2nd ed. Revised, by W. Haresign. London: Butterworths.
- 1979. *Recognition and Treatment of Common Sheep Ailments*. London: Farming Press.

# GLOSSARY OF SHEEP TERMS

- Abortion** — Abnormal or early termination of pregnancy.
- Anaplasmosis** — A blood disease of cattle caused by a minute protozoan parasite.
- Anemia** — Deficiency of red blood cells and/or quantity of pigment known as hemoglobin.
- Antibodies** — Circulating protein molecules that help neutralize disease organisms.
- Autogenous vaccines** — Vaccine made from organisms collected from a specific disease outbreak.
- Black face breeds** — Meat breeds of sheep.
- Black fleece** — Fleece containing so many black fibers that white or light colored cloth cannot be made from it; thus, the wool's value is reduced.
- Booster vaccination** — A second or multiple vaccination given to increase an animal's resistance to a specific disease.
- Breech birth** — A birth in which the hind feet of the young are presented first.
- Breed** — Animals of like color, body shape, and wool grade similar to those of parents.
- Broken-mouth** — A sheep that has lost part of its permanent incisors, usually at 5 or more years of age.
- Bummer or orphan** — A lamb that is not raised by its mother; usually it is raised on a bottle.
- Castrate** — Removal of male sheep testes.
- Clip** — Wool from a given flock; also, total yearly production.
- Colorado tick fever** — A disease of humans caused by a virus transmitted by ticks.
- Colostrum** — First milk a ewe gives after birth. High in antibodies, this milk protects newborn lamb against diseases.
- Condition** — Amount of fat and muscle tissue on an animal's body.
- Constipation** — A condition in which the contents of the large intestines (bowels) are discharged at long intervals or with difficulty.
- Creep** — A feeding area where lambs can feed but ewes are excluded.
- Crimp** — Natural waviness of wool fibers.
- Crossbreed sheep** — A sheep resulting from the mating of two different breeds.
- Crutching or tagging** (verb) — Removing wool from the inside of a sheep's back legs and belly.
- Crutchings** (noun) — Wool removed from sheep during the crutching or tagging process. This wool usually is free of manure as opposed to tags—which contain a lot of manure.
- Cull** — To sell or eliminate from a flock.
- Dam** — A female parent.
- Dental pad** — An extension of the gums on the front part of the upper jaw. It is a substitute for top front teeth.
- Diarrhea** — Watery feces ("scouring" with staining of wool around the breach).
- Dock** (noun) — Stub end of the sheep's tail.
- Docking** (verb) — To remove the sheep's tail.
- Drench** — A means of giving liquid medicine by mouth.
- Emaciation** — Loss of flesh resulting in extreme leanness.
- Energy** — A nutrient category of feeds usually expressed as TDN (total digestible nutrients).
- Epididymis** — Tubules that carry sperm from ram's testicles to the spermatic cord.
- Estrus** — The ewe is receptive (can mate with the ram) and can conceive (become pregnant).
- Ewe** — A female sheep.
- Finishing** — The act of feeding an animal to produce a desirable carcass for market.
- Fleece** — Wool as it is shorn from the sheep; the fleece should remain in one piece.
- Flushing** — Increasing the plane of nutrition of a ewe before and during the breeding season.
- Fly strike** — When green and blue blowflies lay eggs in wet and stained wool and maggots develop.
- Gestation** — Same as pregnancy.
- Graft** — A procedure in which a ewe raises a lamb that is not her own.
- Granny ewe** — A pregnant ewe close to lambing tries to claim another ewe's newborn lamb.
- Grease wool** — Wool shorn from the sheep before it has been cleaned.
- Jaundice** — Yellowishness of the skin, mucous membranes, and secretions.
- Jug or jail** — A 4 feet by 4 feet or 5 feet by 5 feet pen where a ewe and her lambs are put for the first 24 hours after birth.
- Kemp** — A chalky white, brittle, weak fiber found mixed with normal fibers of a fleece; kemp will not take dye; thus, the fleece's value is reduced.
- Lactation** — When the ewe is giving milk.
- Lamb** — Young sheep of either sex under 1 year of age.
- Lambing out of the wool** — Ewes shorn before they lamb.
- Larvae** — Immature stages of adult parasite; the term applies to insects, ticks, and worms.
- Libido** — Usually refers to the ram's sex drive.
- Lymphatic (lymph)** — Pertaining to a system of vessels used for conveying the liquid portion of blood (lymph).
- Mastitis** — Inflammation of the udder.
- Nymph** — A young stage of insects and ticks unlike the adult, having incompletely developed sex organs.
- Oocyst** — A minute pouch or sacklike body containing a fertilized cell of a parasite.
- Orchitis** — Inflammation of the testicle.

**Overshot or parrot mouth** — When the lower jaw is shorter than the upper jaw and the teeth hit in back of the dental pad.

**Ovulation** — Egg released from the ovary.

**Parturition** — Act of birth.

**Pelt** — The skin of a sheep with the wool on.

**Pneumonia** — Infection in the lungs.

**Protein** — A nutrient category of feed used for growth, milk, and repair of body tissue.

**Puberty** — When a sheep becomes sexually mature.

**Pulpy kidney** — Another name for enterotoxemia.

**Puparia** — Resting stages (nonfeeding) of insects.

**Purebred animal** — An animal of a recognized breed kept pure for many generations. A purebred animal may or may not be registered, but all registered animals are purebred.

**Quarantine** — To isolate or separate an animal from other sheep.

**Ram or buck** — Male sheep of any age that has not been castrated.

**Ration** — Total feed given an animal during a 24-hour period.

**Rectal prolapse** — A portion of the rectum protrudes past the anus.

**Registered animal** — A purebred animal that has a registration certificate and number issued by the breed association.

**Scoured wool** — Wool that has been cleaned or scoured.

**Scouring** — See diarrhea in reference to discharge of animal feces; also a term used in cleansing wool.

**Seasonal breeders** — Ewes only show estrus during part of the year; estrus season depends on breed and climate.

**Smooth-mouth** — A sheep that has lost all of its permanent incisors, usually 7 or more years of age.

**Staple** — Common reference to length of wool fibers.

**Tags** — Heavy, manure-covered locks of wool.

**Teaser ram** — A ram that has had the spermatic cords cut or tied (vasectomy). These males cannot impregnate ewes but have sex drive.

**Tender wool** — Wool that has a weak or tender area in it. The tender area is called a break. Wool fiber that breaks at this point reduces wool value.

**Trachea** — Windpipe leading from the throat to lungs.

**Undershot** — Lower jaw is longer than the upper, and teeth extend forward past the dental pad on upper jaw.

**Vascular** — Pertaining to, or provided with vessels; usually refers to veins and arteries.

**Vasectomied ram** — A ram that has had the spermatic cords cut and cannot ejaculate sperm cells.

**Virulence** — An organism's ability to produce disease.

**Wether** — A male sheep castrated before the development of secondary sex characteristics.

**White face breeds** — Wool breeds of sheep.

**Wool blind** — A condition where the wool grows too close to the eyes. This is opposed to open face where there is a large area around the eyes free of wool.

**Wool tie** — A string or twine made of paper used for tying fleeces.

**Yearling** — A sheep of either sex that is approximately 1 to 2 years of age, or a sheep that has cut its first set of incisors.

**Yolk** — The natural yellow grease in a fleece that keeps the wool in good condition.

To simplify information, trade names of products have been used. No endorsement of named products is intended, nor is criticism implied of similar products which are not mentioned.

## COOPERATIVE EXTENSION

## UNIVERSITY OF CALIFORNIA

This information is provided by Cooperative Extension, an educational agency of the University of California and the United States Department of Agriculture. Support for Cooperative Extension is supplied by federal, state, and county governments. Cooperative Extension provides the people of California with the latest scientific information in agriculture and family consumer sciences. It also sponsors the 4-H Youth program. Cooperative Extension representatives, serving all counties in California, are known as farm, home, or youth advisors. Their offices usually are located in the county seat. They will be happy to provide you with information in their fields of work.

The University of California in compliance with the Civil Rights Act of 1964, Title IX of the Education Amendments of 1972, and the Rehabilitation Act of 1973 does not discriminate on the basis of race, creed, religion, color, national origin, sex, or mental or physical handicap in any of its programs or activities, or with respect to any of its employment policies, practices, or procedures. The University of California does not discriminate on the basis of age, ancestry, sexual orientation, marital status, citizenship, nor because individuals are disabled or Vietnam era veterans. Inquiries regarding this policy may be directed to the Affirmative Action Officer, Division of Agriculture and Natural Resources, 2120 University Ave., University of California, Berkeley, California 94720 (415) 644-4270.

Issued in furtherance of Cooperative Extension work, Acts of May 8 and June 30, 1914, in cooperation with the U.S. Department of Agriculture. Jerome B. Siebert, Director of Cooperative Extension University of California

3m-pr-3/85-LE/VG



## SHEEP TERMS

A good livestock vocabulary is essential to the preparation and presentation of reasons. There are usually several ways to say the same thing. The skilled reason giver makes use of as many of these as he can and thereby adds variety to his presentation. The student judge should be alert to add new terms and phrases to his vocabulary. These terms can usually be fit into a category or classification such as terms related to type or structural correctness or perhaps breed style or character. These terms can be stated positively or negatively as well as comparatively.

### I. General Terms

<u>Positive</u>	<u>Comparative</u>	<u>Negative</u>
1. Typey	Typier	Off type
2. Modern type	More modern type	Old fashioned type
3. Long bodied	Longer bodied	Short or compact
4. Long rumped	Longer rumped	Short rumped
5. Upstanding	More upstanding	Low set
6. Tall	Taller	Short legged
7. Square at the dock	Squarer at the dock	Tapered at the dock
8. Strong topped	Stronger topped	Weak topped
9. Straight lined	Straighter lined	Slack framed
10. Thick	Thicker	Narrow
11. Thick topped	Thicker Topped	Narrow Topped
12. Thick at the crops	Thicker at the crops	Narrow at the crops
13. Thick (wide) loin	Thicker (wider) loin	Narrow loin
14. Long loin	Longer loin	Short loin
15. Long hindsaddle	Longer hindsaddle	Short hindsaddle
16. Thick muscled	Thicker muscled	Light muscled
17. Thick leg	Thicker leg	Narrow leg
18. Plump leg	Plumper leg	Tapered leg
19. Deep twist	Deeper twist	Shallow twist
20. Wide at the chest floor	Wider at the chest floor	narrow fronted
21. Spring of rib	Greater spring of rib	Flat ribbed
22. Balanced	More nicely balanced	Poorly balanced
23. Balanced and symmetry	Greater balanced and symmetry	Lacks balance and symmetry
24. Trim	Trimmer	Wasty
25. Clean fronted	Cleaner fronted	Heavy fronted
26. Smooth shouldered	Smoother shouldered	Coarse shouldered
27. Tight framed	Tighter framed	Loose framed
28. Straight topped	Straighter topped	Rough topped
29. Level rumped	Leveler rumped	Droopy rumped
30. Uniform in thickness	More uniformly thick	Narrows to dock

## SHEEP TERMS

Terms underlined refer to important, overall factors. Terms not underlined are considered as being more or less details.

The terms are numbered only for ease of reference and are not necessarily in any order of importance. For simplicity, terms are presented in only one manner but can be modified and used in a variety of ways.

### I. General Terms for Breeding and Market Sheep

<u>Comparative terms</u>	<u>Criticisms</u>
1. <u>Typier</u> . . . . .	Off type
2. <u>Heavier muscled; meatier</u> . . . . .	Light muscled
3. <u>Thicker</u> . . . . .	Narrow
4. <u>Higher quality</u> . . . . .	Coarse; low quality
5. <u>More nicely balanced</u> . . . . .	Poorly balanced
6. <u>More stylish</u> . . . . .	Plain
7. <u>Deeper body</u> . . . . .	Shallow body
8. <u>Deeper rib</u> . . . . .	Shallow rib
9. <u>Deeper flank</u> . . . . .	Shallow flank; high in flank
10. <u>Shorter neck</u> . . . . .	Long neck
11. <u>Wider (thicker) top; (heavier muscled)</u> . . . . .	Narrow top
12. <u>Greater spring of rib</u> . . . . .	Narrow forerib
13. <u>Fuller behind the shoulder</u> . . . . .	Narrow behind the shoulders
14. <u>Wider back</u> . . . . .	Narrow back
15. <u>Wider rump</u> . . . . .	Narrow rump
16. <u>Wider loin</u> . . . . .	Narrow loin
17. <u>Longer rump</u> . . . . .	Short rump
18. <u>More level rump</u> . . . . .	Drooped at rump; low at pins
19. <u>Wider dock</u> . . . . .	Narrow dock
20. <u>Deeper twist</u> . . . . .	Shallow twist
21. <u>Thicker leg</u> . . . . .	Narrow leg
22. <u>Deeper leg</u> . . . . .	Shallow leg
23. <u>Plumper leg</u> . . . . .	Light leg
24. <u>Nicer handling</u> . . . . .	Poor handling
25. <u>Smoother shoulders</u> . . . . .	Rough (coarse) shoulders
26. <u>Stronger top</u> . . . . .	Weak top
27. <u>Tighter frame</u> . . . . .	Slack frame
28. <u>Straighter top</u> . . . . .	Low top; low front
29. <u>More uniform (even) depth</u> . . . . .	Shallow forerib; shallow leg; heavy middle

Sheep terms - cont'd

II. Market lamb Terms

<u>Comparative Terms</u>	<u>Criticisms</u>
1. <u>Meatier, heavier muscled</u> . . . . .	Light muscled
2. <u>Trimmer finished</u> . . . . .	Overdone, excessively finished
3. <u>Fatter</u> . . . . .	Thin, under-finished
4. <u>More uniformly (evenly) finished;</u> <u>more uniformly covered</u> . . . . .	Unevenly covered
5. <u>Firmer finished</u> . . . . .	Soft finished
6. <u>Trimmer middled</u> . . . . .	Wasty middled; heavy middled
7. <u>Heavier muscled leg</u> . . . . .	Light muscled leg
8. <u>Firmer leg</u> . . . . .	Soft leg
9. <u>Trimmer</u> . . . . .	Wasty
10. <u>Trimmer fronted; neater fronted</u> . . . . .	Heavy fronted; wasty fronted
11. <u>Would hang up a:</u>	<u>Would hang up a:</u>
<u>Thicker carcass</u> . . . . .	Narrow carcass
<u>heavier muscled, meatier carcass</u> . . . . .	carcass light muscled
<u>more shapely carcass</u> . . . . .	long, narrow carcass
<u>neater (trimmer) carcass</u> . . . . .	wasty (over-finished) carcass
<u>Would yield higher</u> . . . . .	<u>Would yield low</u>

III. Breeding Sheep Terms

<u>Comparative terms</u>	<u>Criticisms</u>
1. <u>More (Hampshire, etc.) breed character</u> <u>about the head; breeder head</u> . . . . .	Plain head
2. <u>More feminine head</u> . . . . .	Coarse head
3. <u>Stronger head (especially rams)</u> . . . . .	Weak head
4. <u>More rugged (heavier bone)</u> . . . . .	Light bone; fine bone
5. <u>Stronger fronted</u> . . . . .	Weak fronted
6. <u>Wider fronted</u> . . . . .	Narrow fronted
7. <u>Straighter legged (rear or front).</u> . . . . .	Cow hocked; sickle hocked (too much angle or set to hock) toed out; close at knees; back at knees; over at knees; post legged (straight hocked)
8. <u>Longer fleece</u> . . . . .	Short fleece
9. <u>Denser fleece</u> . . . . .	Open fleece
10. <u>Finer fleece</u> . . . . .	Coarse fleece
11. <u>More uniform fleece</u> . . . . .	Uneven fleece

## II. Market Lamb Terms

<u>Positive</u>	<u>Comparative</u>	<u>Negative</u>
1. Meaty	Meatier	Light muscled
2. Muscular	More muscular	Light muscled
3. Thick muscled	Thicker muscled	Light muscled
4. Heavy muscled leg	Heavier muscled leg	Light muscled leg
5. Natural thickness	More natural thickness	Narrow made
6. Correctly finished	More correctly finished	Over finished or under finished
7. Firm handling	Firmer handling	Soft
8. Hard finished	Harder finished	Soft
9. Clean middle	Cleaner middled	Wasty middled
10. High yielding	Higher yielding	Low yielding
11. Uniform in finish	More uniformly finished	Unevenly finished
12. Would hang up a:		
Meaty carcass	Meatier carcass	Wasty carcass
shapely carcass	Shaplier carcass	Narrow carcass
Thick carcass	Thicker carcass	Light muscled carcass

## III. Breeding Sheep Terms

1. Breed character about the head	More (state breed) Breed character about the head	Ordinary about the head
2. Rugged	Ruggedder	Light framed
3. Heavy boned	Heavier boned	Light boned
4. Constitution	More constitution	Lacks constitution
5. stands correctly	Stands more correctly	Cow hocked Sickle hocked down on pasterns Post legged
6. Width in Front	Wider fronted	Narrow fronted
7. Burlly	Burlier	Refined
8. Feminine headed	More feminine headed	Coarse headed
9. Strong headed	Stronger headed	Lacks musculinity in the head
10. Dense Fleece	Denser Fleece	Open Fleece
11. Long Stapled	Longer stapled	Short stapled
12. Heavy shearing fleece	Heavier shering fleece	Light shearing fleece
13. Typical (state breed) fleece	More typical (state breed) fleece	Fleece untypical of (state breed)
14. Clean fleece	Cleaner fleece	Wasty fleece con- taining block fiber

## LAMB TERMS

1. Was a harder, firmer-fleshed lamb that should hang the cleanest, trimmest, most shapely leg in the class.
2. Was a nicer-handling lamb that was more uniformly covered over his top and firmer in his leg.
3. A firmer, harder, nicer-handling wether that was cleaner over the rib and freer of waste over the loin.
4. A cleaner-fronted, tighter-middled lamb that should have a higher yield of leg and loin.
5. A higher-quality, firmer handling, cleaner-made lamb, that was trimmer about the middle and cleaner about the shoulder, neck and brisket.
6. A trimmer-fronted lamb that was more correct in his finish over the rib, back and loin and displayed more firmness through the leg than any other lamb in the class.
7. A wasty, over-finished, heavy-fronted lamb that should hang up the least desirable carcass that would require the greatest trim.
8. Was a short-made, heavy-fronted, low-set lamb that was early maturing and should produce a lightweight, wasty carcass.
9. Was a longer-bodied lamb that was longer through the rump and loin and proportionately heavier in the hindsaddle.
10. Was an extremely wasty, soft, over-finished lamb that should hang a carcass with the greatest percent kidney, heart and pelvic fat.
11. Should hang up a more desirable carcass, yielding a minimum waste and a maximum amount of lean.

### General Information

- a. Desirable amount of finish - 0.1 to 0.2 of an inch of fat over the 12th rib. A lamb carcass has 13 ribs.
- b. Desirable amount of loineye area - 2.5 square inches (3.0 square inches as a goal) per 50-pound carcass. Most 100-pound lambs will hang a 50-pound carcass.
- c. Lamb carcass weight breakdown:

#### hindsaddle

leg - 33%  
loin - 17%  
Total - 50%

#### foresaddle

rack - 11%  
breast and shoulder - 39%  
total - 50%