

# GUIDE DOG PROJECT

## 4-H Record

Complete this record as accurately as you can. When your puppy returns to Guide Dogs for the Blind, return this record with the dog. Keep an accurate record of all the things you do in the Guide Dog Project. In addition to this record and at the end of the 4-H year, complete an *Annual 4-H Project Report* (4-H-1070) and give it to your leader.

Puppy's name \_\_\_\_\_ Number \_\_\_\_\_

Breed \_\_\_\_\_

4-H member's name \_\_\_\_\_

Street or RFD address \_\_\_\_\_

Town, county, state, and ZIP code \_\_\_\_\_

Your puppy was born \_\_\_\_\_

At 12 weeks, your puppy measured \_\_\_\_\_ inches from the ground to the top of the shoulder

and weighed \_\_\_\_\_ pounds.

Measure your puppy every 4 weeks and record in inches:

(weeks) \_\_\_\_\_  
                     16th                      20th

24th	28th	32nd
36th	40th	44th
48th	52nd	final

Weigh your puppy every 4 weeks and record in pounds:

(weeks) \_\_\_\_\_  
   16th                      20th

24th	28th	32nd
36th	40th	44th
48th	52nd	final

Your puppy has had the following inoculations:

- at 6 weeks of age: measles vaccine, distemper
- at 9 weeks of age: distemper, hepatitis, leptospirosis, parainfluenza
- at 11 weeks of age: distemper, hepatitis, leptospirosis, parainfluenza

Your puppy was wormed at 6, 9, and 11 weeks of age.

Division of Agricultural Sciences  
 UNIVERSITY OF CALIFORNIA

REVISED JANUARY 1980

4-H-1113

# IF YOUR PUPPY GETS SICK OR HURT

Take This Sheet to Your Veterinarian with Your Puppy

## Instructions for the Puppy Raiser

If your puppy gets sick or injured at any time, take him to your veterinarian. Have your veterinarian send a report to 4-H Puppy Placement at Guide Dogs for the Blind, Inc. in San Rafael. Whenever you take your puppy to the veterinarian, take this sheet with you so that the veterinarian can enter the treatment given the puppy.

A staff veterinarian is available during the week at Guide Dogs for the Blind at no cost to 4-H members. Please call for an appointment first: (415) 479-4000 weekdays and 479-4003 weekends.

If your puppy is a female, *she is not to be spayed* without approval of the staff veterinarian.

Female pups may be "in season" one or more times from 6 months of age until the start of training. Check your pup frequently and, as soon as she shows signs of coming "in season," board her at a local kennel for the full cycle, which may be 3 weeks. You may send an itemized bill for the boarding to Guide Dogs for the Blind. If you live close to either the San Rafael or Topanga Canyon facilities, it is better to board your pup there.

Each time you board your dog in a kennel or at a veterinarian's, for any reason, please ask the owner or manager to answer the following questions.

Kennel name \_\_\_\_\_

Name of person completing form \_\_\_\_\_

Dates in kennel \_\_\_\_\_ to \_\_\_\_\_

Reason \_\_\_\_\_

Appetite

- Excellent
- Good
- Poor
- Refused food for \_\_\_\_\_ days

Activity level

- Overly active
- Normally active
- Calm
- Seemed depressed

Attitude (in kennel run)

- Friendly
- Reserved
- Timid
- Aggressive

Please describe briefly any experience, behavior, or events of a remarkable or unusual nature that you observed while the dog was in your care

---

---

---

---

## Instructions to the Veterinarian

This puppy has been inoculated as noted and will need inoculation against rabies between 4 and 6 months of age. Send an itemized bill to Guide Dogs for the Blind, Inc., P.O. Box 1200, San Rafael, California 94902.

In case of other illness or accident and, if time permits, call (415) 479-4000 Ext. 56 to request instructions or authorization from the staff veterinarian. If you are unable to reach a staff veterinarian, you are authorized to use your own judgment. If radiographs are necessary to confirm your diagnosis, please submit the films to Guide Dogs for the Blind, Inc. (They will be returned to you.)

Please furnish an itemized statement with any necessary billing.

For the following treatments, please complete the information. Thank you for your help and cooperation.

Rabies inoculation \_\_\_\_\_  
date given

\_\_\_\_\_ type of inoculation

\_\_\_\_\_ supplier's name

Other inoculations \_\_\_\_\_  
date given

\_\_\_\_\_ type of inoculation

\_\_\_\_\_ supplier's name

## SOCIALIZATION AND TRAINING

There will be socializing and training meetings for 4-H Guide Dog puppies for your group. You are expected to attend with your puppy. Your Member's Guide and your project leader will help you socialize, care for, and train your puppy correctly. Please follow instructions carefully.

### 4-H Puppy Raising Class Record

Date of first meeting attended \_\_\_\_\_

Number of meetings attended \_\_\_\_\_

How often did you socialize your puppy \_\_\_\_\_

How often did you do obedience exercises with your puppy \_\_\_\_\_

## YOUR DOG'S HABITS AND BEHAVIOR

Before you return your dog to Guide Dogs for the Blind, Inc., answer the following questions as accurately as you can. Your answers will be very important in determining how to best handle your dog in training and in matching this dog with the blind person.

### Reaction to Strangers

How does your dog react to visitors to your home? (You may check more than one.)

- | Men                                 | Women                               | Children                            |
|-------------------------------------|-------------------------------------|-------------------------------------|
| <input type="checkbox"/> Friendly   | <input type="checkbox"/> Friendly   | <input type="checkbox"/> Friendly   |
| <input type="checkbox"/> Reserved   | <input type="checkbox"/> Reserved   | <input type="checkbox"/> Reserved   |
| <input type="checkbox"/> Timid      | <input type="checkbox"/> Timid      | <input type="checkbox"/> Timid      |
| <input type="checkbox"/> Aggressive | <input type="checkbox"/> Aggressive | <input type="checkbox"/> Aggressive |

How does your dog react to strangers away from home?

- | Men                                 | Women                               | Children                            |
|-------------------------------------|-------------------------------------|-------------------------------------|
| <input type="checkbox"/> Friendly   | <input type="checkbox"/> Friendly   | <input type="checkbox"/> Friendly   |
| <input type="checkbox"/> Reserved   | <input type="checkbox"/> Reserved   | <input type="checkbox"/> Reserved   |
| <input type="checkbox"/> Timid      | <input type="checkbox"/> Timid      | <input type="checkbox"/> Timid      |
| <input type="checkbox"/> Aggressive | <input type="checkbox"/> Aggressive | <input type="checkbox"/> Aggressive |

Does your dog frequently jump up on people? \_\_\_\_\_

Has your dog ever bitten anyone? \_\_\_\_\_

If yes, please give complete written description on the blank pages provided.

### Reaction to Other Animals

Around other dogs, my dog is:

- Excitable
- Calm
- Curious
- Friendly
- Disinterested
- Timid
- Aggressive

Around other animals, my dog is usually:

- Excitable
- Calm
- Curious
- Friendly
- Disinterested
- Timid
- Aggressive

Please specify any animals that cause your dog to become excited, timid, or aggressive. Write this information down on one of the blank pages.

Has your dog ever fought with another dog? \_\_\_\_\_

Has your dog ever killed another animal? \_\_\_\_\_

If yes, please write the details in the blank pages provided.

### Reactions to the Environment

After careful consideration, indicate your dog's reaction to the following situations. In the spaces, put: E = excited, C = calm, U = uneasy, F = frightened, ? = don't know.

\_\_\_\_\_ Cars (while riding)

\_\_\_\_\_ Passing cars

\_\_\_\_\_ Machinery

\_\_\_\_\_ Bicycles

\_\_\_\_\_ Shopping carts

\_\_\_\_\_ Skateboards

\_\_\_\_\_ Wheelchairs

\_\_\_\_\_ People on crutches

\_\_\_\_\_ People carrying parcels

\_\_\_\_\_ Crowds

\_\_\_\_\_ Loud noises

\_\_\_\_\_ Thunderstorms

\_\_\_\_\_ Fireworks

Other (describe briefly):

---



---



---



---



---



---

How often did you walk your dog in town? \_\_\_\_\_

How often did your dog ride in a car? \_\_\_\_\_

Does your dog get car sick? \_\_\_\_\_

If yes, explain:

- Frequently
- Long rides only
- Bumpy roads only
- Other

---



---



---

Does your dog ever salivate (drool) enough to cause his jaw or throat to become wet?

- Frequently
- Occasionally
- Seldom
- Never

If yes, what seems to most often cause this reaction (riding in a car, meal time, when excited or nervous)?

---



---



---



---



---

Has your dog been allowed to run free? \_\_\_\_\_

If so, how often and under what circumstances?

\_\_\_\_\_  
\_\_\_\_\_  
\_\_\_\_\_

**House Behavior**

When left at home alone, do you leave your dog:

- Free in the house
  - On tie-down in the house
  - In a fenced yard or pen
- Other (please specify):

\_\_\_\_\_  
\_\_\_\_\_  
\_\_\_\_\_

When at home alone, is your dog:

- Noisy
- Destructive (chewing, digging, etc.)

Does your dog attempt to escape from the house, yard, or pen?

\_\_\_\_\_

If yes, indicate how (by digging, climbing fence, bolting through open door, other):

\_\_\_\_\_  
\_\_\_\_\_

If your dog ever escaped or ran away, how many times did this happen and how long was the dog gone?

\_\_\_\_\_  
\_\_\_\_\_

\_\_\_\_\_  
\_\_\_\_\_  
\_\_\_\_\_

Does your dog ever relieve himself indoors? \_\_\_\_\_

If yes, how often and where (friend's house, stores, other)?

\_\_\_\_\_  
\_\_\_\_\_

Does your dog relieve readily:

- On leash
- In yard or pen
- Away from home

Approximately how many hours per day does your dog spend:

\_\_\_\_\_ Indoors

\_\_\_\_\_ Outdoors

**Feeding and Health**

Is your dog's appetite:

- Regular
- Irregular
- Voracious
- Depraved (eats sticks, stones, droppings, other)

What was your dog's regular diet (type of food, amount in cups or pounds, number of times fed daily)?

\_\_\_\_\_  
\_\_\_\_\_  
\_\_\_\_\_

What foods did your dog receive in addition to his regular diet?

\_\_\_\_\_  
\_\_\_\_\_

Does your dog grab food:

- From your hand
- From tables or counters

Can your dog be trusted if left alone in a room with food within reach? \_\_\_\_\_

Does your dog allow you to remove his food dish or bones while he is eating? \_\_\_\_\_

Have you ever noticed your dog limping? \_\_\_\_\_  
If so, when and for how long?

\_\_\_\_\_  
\_\_\_\_\_  
\_\_\_\_\_

Which leg? \_\_\_\_\_

What was the cause?  
\_\_\_\_\_

\_\_\_\_\_  
\_\_\_\_\_  
\_\_\_\_\_  
\_\_\_\_\_  
\_\_\_\_\_  
\_\_\_\_\_  
\_\_\_\_\_  
\_\_\_\_\_  
\_\_\_\_\_  
\_\_\_\_\_  
\_\_\_\_\_

Has your dog ever had any kind of skin trouble?

\_\_\_\_\_

Ear trouble? \_\_\_\_\_

Eye trouble? \_\_\_\_\_

If so, describe: \_\_\_\_\_

\_\_\_\_\_  
\_\_\_\_\_  
\_\_\_\_\_  
\_\_\_\_\_

How often did you clean:

Ears \_\_\_\_\_

Eyes \_\_\_\_\_

Coat \_\_\_\_\_

If you or your parents feel additional comments, notes, or explanations may be important, please feel free to put them on the following pages. *Please print.*









# How to Raise Your GUIDE DOG PUPPY



Good health and normal growth are as important in the proper development of a good dog as they are in that of any animal. If you carefully follow these instructions your puppy should keep well and strong and grow up to be a class A-1 Guide Dog prospect.

You have been entrusted with a purebred puppy from highly selected breeding stock of a strain developed especially by Guide Dogs for the Blind, Inc. to lead sightless people.

This puppy has been selected by special aptitude tests which show that it is superior in the natural tendencies which every Guide Dog must inherit. Every effort has been made by the Guide Dog School to deliver this puppy to you in fine physical condition, and with its training enough advanced so that with a daily fifteen minute training period you will have a well-behaved dog from the start.

## PREVENTION SHOTS

Your puppy has had its shots for prevention of distemper and hepatitis. This does not mean that he cannot take these diseases. He should not be knowingly exposed to any disease.

A fenced yard or run from which the pup cannot escape is essential to his safety. No valuable dog (worth \$1,500 when trained) should ever be allowed to run where he is likely to be hit by a car.

Dogs need mental exercise as well as physical exercise. The old idea that a dog should have a quarter section to run on at will has long been exploded. Today we know that a

dog which is given fifteen minutes of brisk training once or twice a day, and a lot of love and understanding, can live the remainder of the day comfortably in his yard and house.

When you are in a safe place like the woods or a large field, let your puppy enjoy a good run. Run and romp with him, but do not leave him to his own ideas about what to do and where to go. Never let him chase stock or poultry. Two fine puppies were shot recently by neighbors of the puppy raisers. The puppy raisers had neglected to keep their dogs under control and the neighbors found them chasing stock and poultry. When you are through with play, put the leash on the puppy and lead him home.

## LEASH CAN MEAN GOOD TIME

By putting the leash on the puppy to take him with you and to bring him home you teach him to associate the leash with a good time. Talk to him as you walk along as with another child. He will not understand all you say, but he will enjoy the attention and eventually will understand many words.

Besides German Shepherds and Boxers, Guide Dogs for the Blind, Inc. uses many hunting breeds. Do not hunt with these dogs. By so doing you may completely spoil them as Guide Dogs. Such dogs have the natural tendency to seek out game, including pigeons which are numerous on most city streets. This natural bent can be overcome in training if the dog has never had the joy of hunting. If it has, it may endanger the life of the person whose safety has been entrusted to

## TRAINING LESSON

it by following its inborn hunting desire and leading a blind person into a bad accident or to his death.

Your dog is going to learn whether you teach him or not. If you do not teach him, he will learn many things, some of which he should not. When you receive the pup he has been taught only desirable things, and exercises which will be an important part of his daily life work.

Your puppy will know about walking on a leash. A Guide Dog always walks on the left side of his owner. Please continue taking the pup for a walk each day with him heeling on your left side. The puppy is delivered to you with his leash and collar. Leave the collar on him at all times. Let out a hole as he grows. If he outgrows the collar measure it and send in to Guide Dogs for the Blind, Inc., San Rafael, California, attention Miss Carol Roever, and ask for a larger collar.

### LEASH IS A SAFETY MEASURE

You will use the leash only when you are training the pup, or taking him for a walk or a ride. Do not tie him up with it or let him run dragging it. Leave it on when you take him for a ride in an automobile as a safety measure for his control.

Your leash has a loop in one end and a snap on the other. Snap it on the collar ring and hook the loop over your right thumb, letting the leash fall across the palm of your right hand, and grasp it. You need not hold the leash with the left hand at all. Keep it as slack as possible and encourage the puppy to walk with you where you want to go. If he wants to go another way at first, walk his way a little, encourage him, and, when he is started, go your own direction and he will follow. Soon you will have the puppy walking with the leash hanging slack and his head about even with or a little ahead of your left knee. This is the way he should heel.

Your puppy has been taught to sit. Be patient. It may take a few days for him to learn that he should obey you as well as he has learned to obey the puppy testers. At first you will stand or kneel close in front of the puppy, raise your right hand, palm down, above his eyes, and say "Sit." As you do so, lower your hand toward the puppy, and, if necessary, place your right hand under his chin and your left hand on his rump and push him gently into a sitting position. Do this three or four times during your training lessons each day. Soon the puppy will sit when either you give the word command or the hand signal.

Once your puppy learns to sit in front of you, you can teach him to sit close to you on your left side. These will be the two positions where he will sit most often with his blind master. Teach the meaning of the word "Sit" and the hand signal so thoroughly that your pup will never fail to obey.

Your puppy has not been taught his name. This you will have the privilege of teaching him. Guide Dogs for the Blind raises too many puppies to name them all. Therefore, no puppy is given a name until he has passed his aptitude tests and is assigned to a home.

Always address the puppy by his name. For instance, say "Roger," count three under your breath to give him time to respond and give you his attention. Then, give the command such as "Heel," "Sit," or "Come." Now count another three under your breath to give the command time to travel to the puppy's ear and give him time to respond. As he grows older and better accustomed to working with you he will respond more quickly.

The command "Come" has been taught in a long narrow room like an inside hall. Such a place in your home or barn is a good place to continue teaching him to "Come." Always put a smile in the command "Come." Get down to the puppy's level at first and make him know you are welcoming him. Clap your hands, praise him

and pet him when he comes. Do not trust him to come if he is in danger. It takes a long while to teach him to come so that he will always obey at once when called. Even you sometimes find other things you want to do before coming when you are called. Allow time for the puppy, but continue until you succeed.

### **PRAISE BEST REWARD**

Praise, stroking and petting are the best rewards you can give a puppy for minding. Never punish a puppy. You can correct him if you are present when he does something wrong. Scolding and preventing him from going ahead with the wrong thing will have the desired effect. If a dog needs punishment someone is to blame for allowing him to develop a bad habit.

A Guide Dog must pick up and bring to his master any object the owner drops. Your puppy has been given retrieving lessons. Not all puppies learn this as well as others. It is desirable for him to like to carry things in his mouth. A dog toy or ball in his yard will encourage him to carry. However, do not use this for the retrieving object during his lessons, because it is his toy.

Roll up a discarded felt hat and put some adhesive tape around it to hold it. It will have your scent, it is light, and easy on his teeth. Get very excited about this precious thing. If he does not retrieve it at once, run after it and pick it up. It may take several days before he enters in the play. When he does, call "Roger — Come" and start running away from him. When he follows with the hat, slow down gradually until you are even with each other. While speaking to him softly and praising him, slip one arm around him, place your other hand under his chin, and remove the hat from his mouth gently, saying "Roger — Give." Then praise him profusely. Retrieve once the first day, twice the next, and up to ten; never more. Make it play.

It is not necessary to tell any 4-H Club member never to tease a dog. It is possible that someone who does not know this may visit you at

some time. If so, be very firm. Impress your visitor that this dog is valuable, that he is becoming a Guide Dog, that teasing makes any dog mean, and that a mean dog could never be trusted with a blind person.

As your dog grows and becomes well trained you should take him in the car, bring him in the house, take him to town on the leash, and let him become accustomed to people and traffic. Your Club leader may want you to bring him to 4-H Club meetings. You may be asked to appear at Service Club meetings with him and at school exercises. Always keep him on a leash at such affairs and always keep him under your control. An inexperienced handler might upset the good work it has taken you weeks to accomplish, or let him loose in a dangerous area where he could be injured or killed. Guide Dogs for the Blind, Inc., does not hold you or your parents legally liable for your dog, but every dog lost to the program causes a break in the plans to provide as many guide dogs as possible.

### **FEEDING INSTRUCTIONS**

Feed your puppy morning and evening. An early evening feeding is advisable so that the puppy will have time to eliminate before bedtime. For the first two days feed kibble only. Use Ken-L-Biskit "Small" or any similar product. Take an empty No. 2 tin can, fill it with kibble and pour into the puppy's feeding dish. Pour enough boiling water or broth over this so that you can see the liquid, leave for half an hour so that the kibble swells before it is eaten, then feed. After two days start adding meat or meat trimming from the table and a teaspoon of bacon drippings if you have them. We feed a half-pound of ground raw horse meat daily. To this add a teaspoon of Vionate and a teaspoon of cod liver oil at each feeding. If the meat is added to the dry kibble and mixed with it before the hot broth or water is poured over it, the food will have a better flavor. A boiled egg twice a week instead of the meat is very satis-

factory. Raw eggs are half lost because the dog passes the raw white as waste.

Your feed dish should be washed and scalded after each meal to prevent algae or fungus poisoning. Enough clean cool water must be provided daily so that the puppy can have all he wants at any time. Scrub and scald the water dish at least once a week. Canned fish may be substituted for meat. Mackerel is very good, but *never* give the puppy home-cooked or raw fish because of the danger of getting bones in his throat. The same applies to chop, chicken, and steak bones. Cooked large bones are bad because they cause compaction in the intestines. While pups like to chew on large raw leg bones they are not necessary to their welfare. If you have a dog of your own besides the puppy you may start a dog fight by feeding bones.

You can judge the amount of food the puppy should have each feeding by the amount he cleans up in five minutes. If he leaves food, cut down the amount. If he cleans it up quickly add a little until you are feeding all he will eat. He should always have as much as he will eat twice daily until he is twelve months of age. Take his dish away after five minutes and wash it.

## VETERINARIAN CAN HELP

If your puppy becomes ill call your veterinarian and ask his advice. If necessary, take him to his office. Your puppy has been wormed, but sometimes dogs get reinfested. Should you suspect worms, follow your veterinarian's advice. If you have to take your puppy to a veterinarian write Mr. William F. Johns, Executive Director, Guide Dogs for the Blind, Inc., San Rafael. He may want to discuss the illness with the doctor. Also consult Mr. Johns by letter when your dog, if you have a bitch puppy, comes into season. Do not have her spayed without the consent of Guide Dogs for the Blind, Inc., which may want to use her for breeding. If spayed too young a dog grows too fast, and may become too large to use as a Guide Dog.

For a mild case of diarrhea, give one tablespoon of Kaopectate four times daily. This can be purchased at any drug store. Withhold meat from the food and give no milk while diarrhea persists. If you do feed milk with the other food, give it after the regular meal and not as a full meal.

Sleep your puppy in a warm dry place free from a draft and feed at regular times.

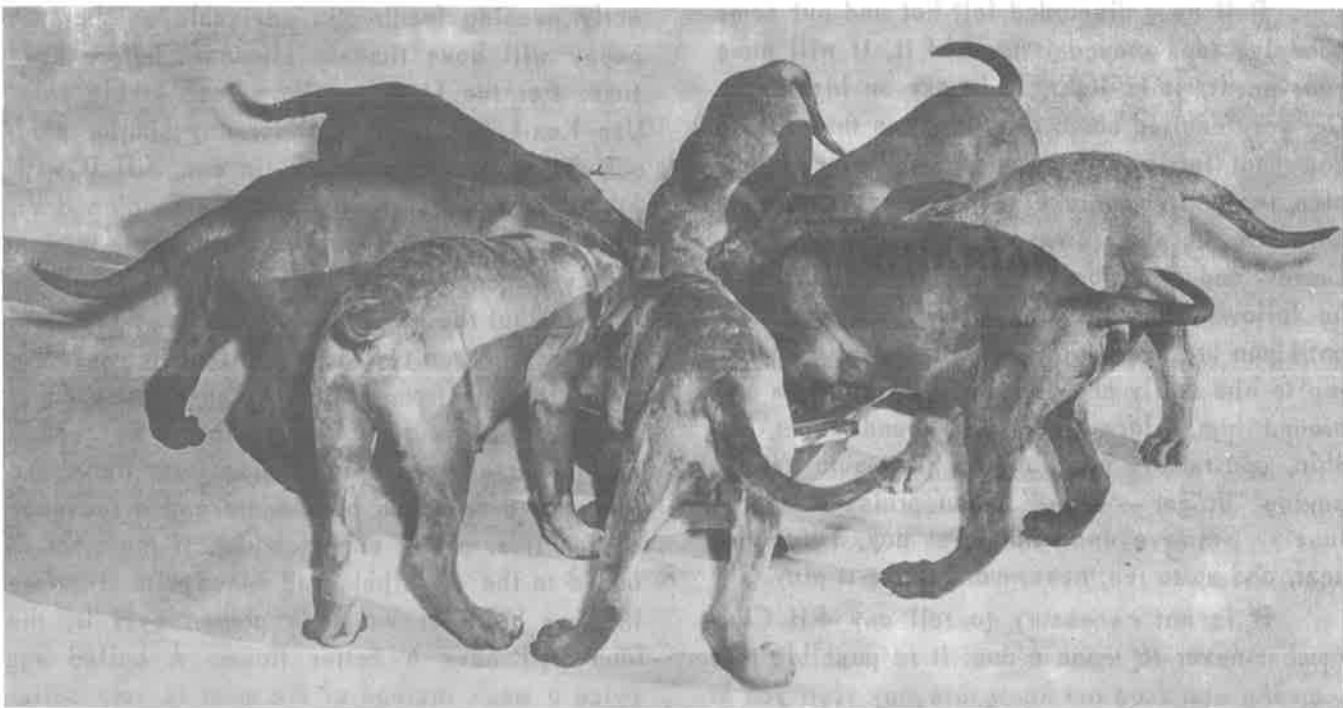

WHEN YOU HAVE PROBLEMS IN  
**TRAINING YOUR PUPPY**

PUT YOURSELF IN YOUR PUPPY'S PLACE.  
THIS WAY YOU WILL SEE WHAT YOU ARE  
DOING.



1. When you call your puppy put a smile  
in your voice. Look Happy.

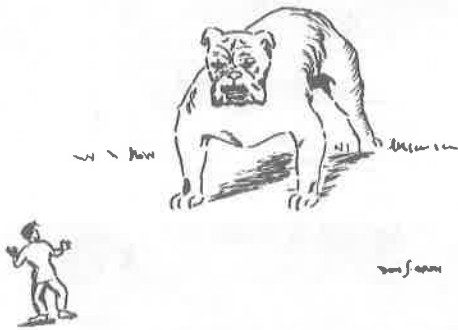

2. Stroke your puppy's head. Do not pat  
it, bang, bang, bang.

Cartoons are by  
Don Gray.  
All rights are  
reserved by him.

3. Guide Dogs have to learn to  
carry things in  
their mouths.

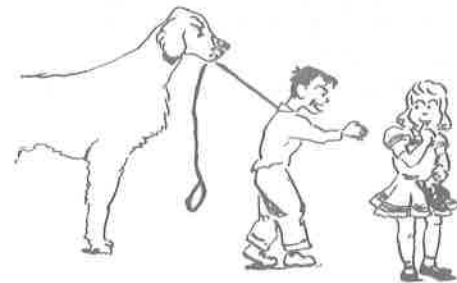
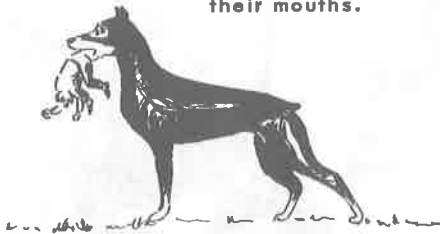

4. Prevent him from doing wrong and  
he will learn to do right.

5. If he persists in doing wrong correct  
him, do not punish him.

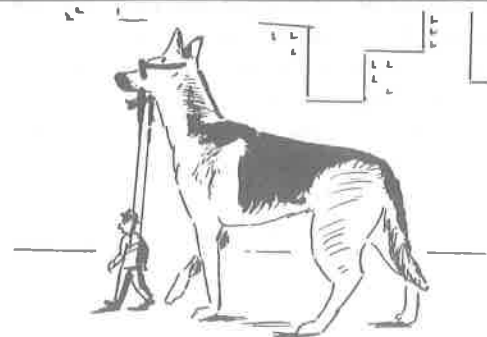
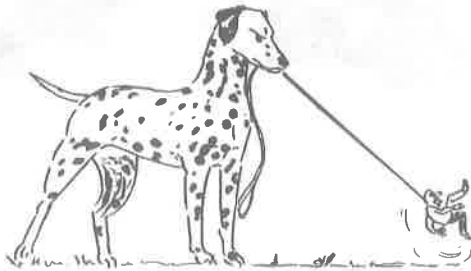

6. He will learn to trust you completely,  
even with his life.



**R**alph Riva of the Greenfield 4-H Club receives Certificate and Guide Dog pin from William F. Johns, Executive Director of Guide Dogs for the Blind, Inc. as he returns Bosco, a German Shepherd he raised from a pup.



*This Manual of Instruction has been prepared by Clarence J. Pfaffenberger, Vice President of Guide Dogs for the Blind, Inc., for the use of 4-H Club members in California. It has been reproduced by The University of California Agricultural Extension Service.*

**NOTE:** In order that this information may be more easily understood, trade names have been used. No endorsement of the named products is intended, nor is criticism implied of similar products which are not mentioned.

-7/55---500

Co-operative Extension work in Agriculture and Home Economics, College of Agriculture, University of California, and United States Department of Agriculture co-operating. Distributed in furtherance of the Acts of Congress of May 8, and June 30, 1914. J. Earl Coke, Director, California Agricultural Extension Service.



# How to Raise a Guide Dog Puppy



## Contents

Introduction . . . . .	3
Housing Your Puppy . . . . .	4
Feeding and Caring for Your Puppy . . . . .	5
Common Ailments, Symptoms, and Treatments . . . . .	7
The Making of a Guide Dog . . . . .	8
Rearing . . . . .	8
Socialization . . . . .	10
Protecting Your Puppy . . . . .	11
Training . . . . .	12
When Your Puppy Returns to Guide Dogs for the Blind . . . . .	15
When You Meet a Blind Person . . . . .	16

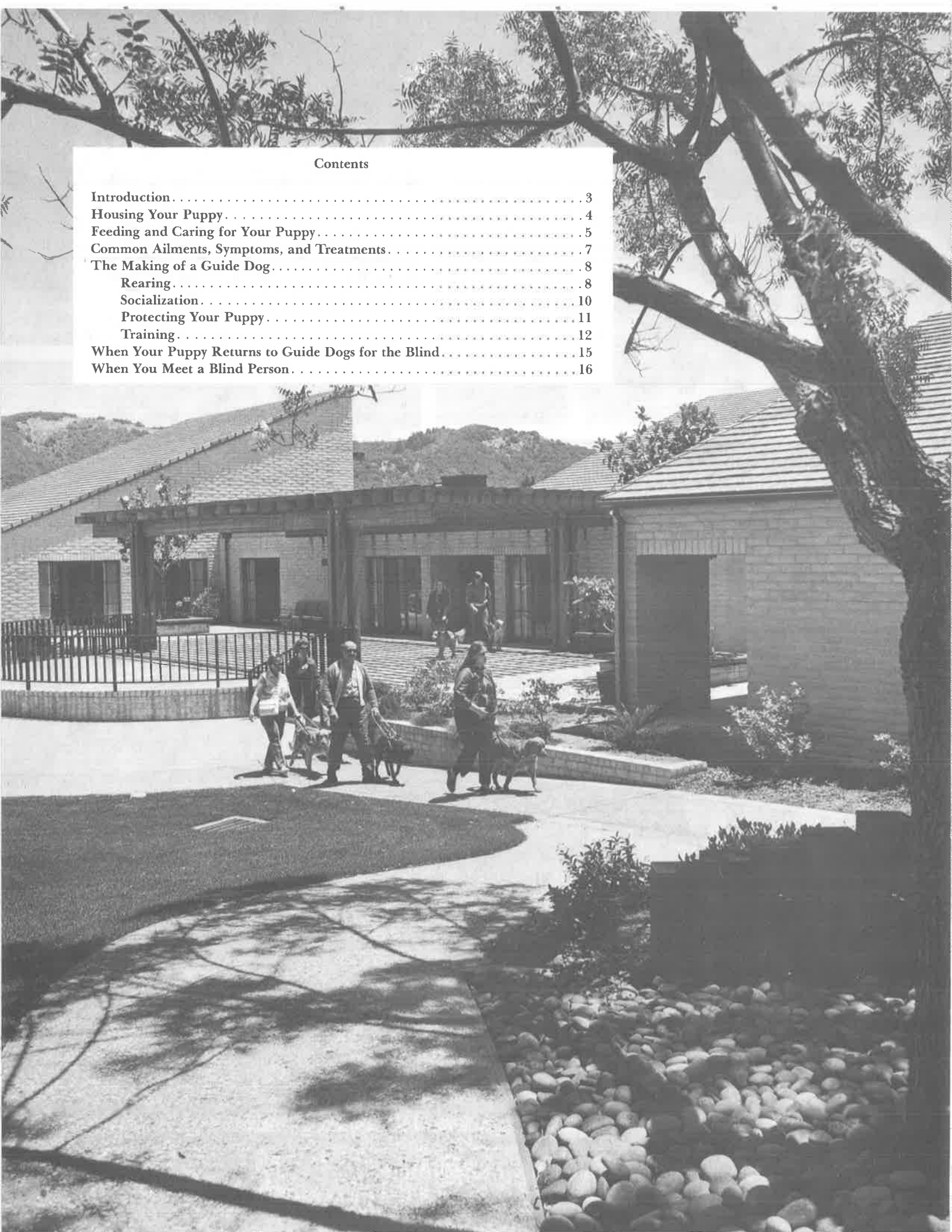



# Introduction

---

Guide Dogs for the Blind, Inc. was founded in 1942 by five Bay Area women, members of a group dedicated to helping blind veterans of World War II. The school's first training facility was located in Los Gatos. In 1947 it was moved to the present 11-acre campus in San Rafael, California.

During the early years of the organization only a few blind persons could be trained with Guide Dogs, but growing response and support of the program made it possible to expand the service to include civilians. Today, more than 200 blind

persons receive Guide Dogs each year.

Each applicant for a Guide Dog is carefully screened for need, ability, and suitability to use this highly sophisticated form of mobility for blind persons. Before receiving his or her Guide Dog, the blind person must complete 28 days of rigorous training while living in the school's 16-person dormitory.

Every Guide Dog puppy, whether from stock owned by Guide Dogs or donated by selected breeders, must pass tests developed by the late Clarence J.

Pfaffenberger. These tests determine whether the puppy has those qualities necessary to become a Guide Dog as an adult. If the puppy completes his tests successfully, he is placed in a 4-H foster home as soon as possible. For the next 12 months the puppy has the happy task of learning about the world in which he will live and work. At approximately 15 months of age he is returned to Guide Dogs' kennels and begins five months of training for the work for which he was bred and raised—to be a Guide Dog.

---

## BEFORE YOUR PUPPY ARRIVES....

- Prepare a bed or sleeping box for your puppy. (See suggestions page 4.)
- Obtain a lightweight chain with at least one swivel in it.
- Choose a food dish and a water dish.
- Make your yard fence dog-tight. You may want to build a run for your puppy. (See suggestions page 4.)
- Select a comb and a stiff brush for daily grooming of your puppy.

## AFTER YOUR PUPPY ARRIVES....

- Give your puppy time to relieve himself *before* he enters the house. Take him to the place where you will want him to go regularly—start housebreaking immediately. (See suggestions on housebreaking page 8.)
- Give your puppy food and water; then let him rest.
- **REMEMBER:** your puppy needs affection, rest, and time to explore and adjust to his new home. Training lessons can wait four or five days.

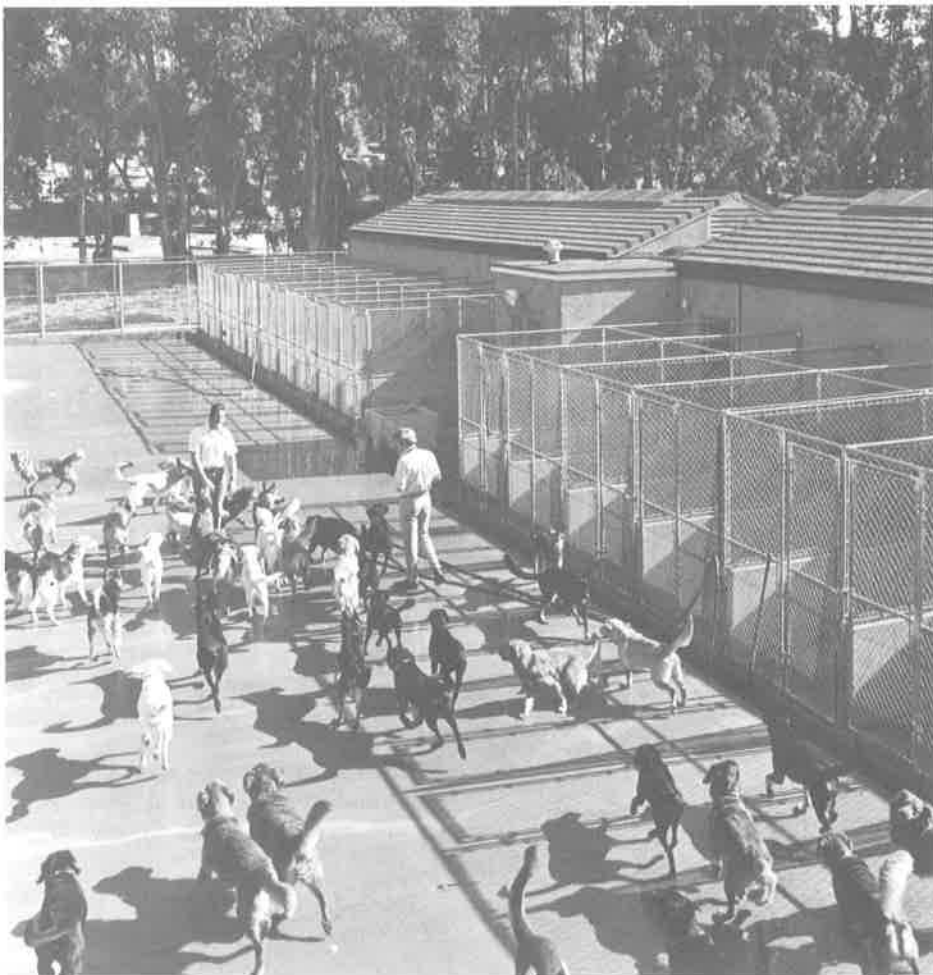

# Housing Your Puppy



## INDOORS:

Construct a simple bed of plywood or use a wooden box. Your puppy will grow fast, so make the bed adult size. It should be enclosed on three sides, 10 to 12 inches high, to keep out drafts; the fourth side should be open. The bed should have a floor smooth enough that the puppy cannot be injured by it. It should have legs 3 inches high to allow air to circulate underneath.

Into the wall behind the bed insert an "eye" screw to which your puppy can be chained. Use a lightweight chain about 1½ times as long as your puppy with at least one swivel so it won't become twisted and hurt the puppy. This will allow the puppy to have enough freedom while on the bed but it will not allow him to go far from it.

You may prefer to use a wire crate or cage (see illustration). These crates may be purchased through or borrowed from Guide Dogs for the Blind, Inc. In any case, your puppy must be indoors in a dry, draft-free room at night.

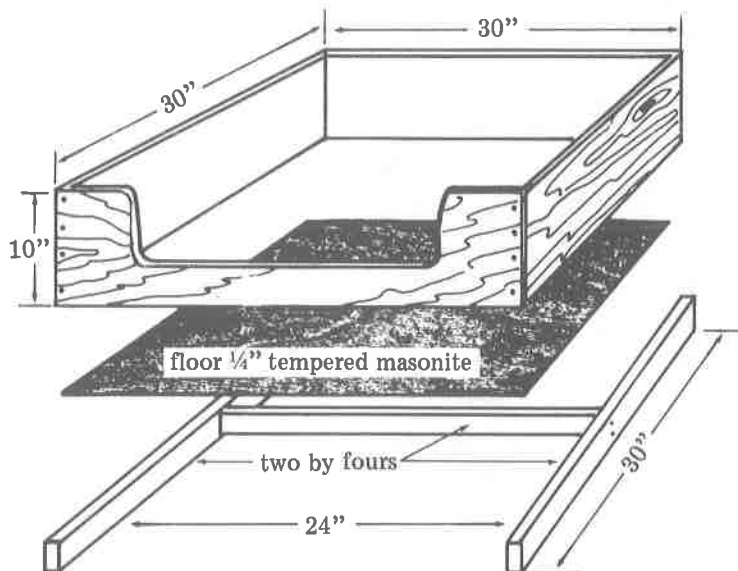

View of a practical dog bed.

## OUTDOORS:

If you do not have a fenced yard, build a run at least 6 to 8 feet wide and 15 to 20 feet long. If your puppy gets used to a run when he first arrives, he will not require anything heavier than turkey wire to keep him in. If you wait until he has grown before you build his run, you may have trouble keeping him inside any enclosure.

The run must include a shelter from sun, rain, and draft, although your puppy should never be left outside in bad weather.

# Feeding and Caring for Your Puppy

Feed your puppy at the same time every day. Start with three meals a day. Cut back to two meals a day at about 16 to 18 weeks of age and to once daily at about 10 to 12 months of age. The last meal of the day should be at early evening so that your puppy will have time to eliminate before bedtime.

You can judge how much to feed by how much your puppy eats in 15 minutes. If he leaves food, cut down on the amount. If he cleans it up quickly, add a little at a time. Usually he should have as much as he will eat readily, twice a day, until he is 10 to 12 months old.

Use the food and *follow the feeding instructions* that are given to you when you get your puppy. For the first three days feed kibble only. After that add meat or meat trimmings and a teaspoon of vegetable oil. (The dogs at Guide Dogs for the Blind, Inc. are fed ½ pound of ground chicken mixed with kibble daily.) Canned beef, chicken, or horsemeat are satisfactory. Mix the meat with warm water to make a broth. Pour the broth over the kibble and mix together. Once a day, add 1 teaspoon Vionate and 1 teaspoon of cod liver oil to the food. A poached egg twice a week may be substituted for meat. Avoid using raw eggs; they are difficult for a dog to digest.

Never give your puppy home-cooked or raw fish as the bones could get caught in his throat. Never offer chop bones, chicken bones, or steak bones; they can splinter and puncture the stomach or intestine. Do give your puppy large, raw beef leg bones; they will help keep his teeth clean of tartar.

NOTE: Cool, clean water should be always available. The water bowl should be scalded at least once a day; the food bowl should be scrubbed and scalded after each meal.



*"...large, raw beef leg bones..."*



## CLEANLINESS:

*Keep your puppy's skin and coat clean with daily combing and brushing. Groom his entire body. Comb and brush around his ears, chest, and belly, inside the legs and under the tail.*

Avoid frequent baths; they can remove the natural oils from your puppy's coat. If you do have to bathe him, do not get soap or water in his ears or eyes. In each ear tuck a large cotton ball to prevent water from entering. (Be sure to remove the cotton after the bath.)

*Keep your puppy's ears clean by wiping them with a damp cloth once a week. Large amounts of wax, if allowed to collect, can be the beginning of ear infections.*

Clean your puppy's face and eyes by wiping them with a damp cloth. It is normal for small amounts of matter to gather at the corners of a dog's eyes occasionally; this can be easily wiped away.

#### IMMUNIZATIONS:

Your puppy has had shots to protect him from distemper, hepatitis, and leptospirosis. He has *not* had a shot for rabies. When your puppy is 4 months old, have your veterinarian give him a rabies shot. You may send the bill to Guide Dogs.

Immunization shots give your puppy a high degree of protection from disease, but you should *never expose your dog to any disease* if you can avoid it.

#### WHEN IN SEASON:

A FEMALE puppy will come into season between the ages of 6 to 12 months. As soon as she does, she should be placed in a boarding kennel for 3 weeks; Guide Dogs for the Blind, Inc. will pay the boarding bill for your female puppy, if necessary. If you live near the San Rafael or the Topanga Canyon Guide Dogs' facility, take her there to be boarded while she is in season.

**DO NOT HAVE HER SPAYED.** This should not be done until she has been returned for training to Guide Dogs.

#### RECOGNIZING ILLNESS:

*Be aware of your puppy's health.* Learn to recognize signs of illness. If you think he is ill, take his temperature with a rectal thermometer lubricated at the tip with some vaseline or mineral oil. Insert half its length into the anal opening, and hold in place for about one minute. (Ask someone to help you keep the puppy calm while you do this.)

A puppy's normal temperature is 101° to 102°F. If your puppy is excited, has been exercising heavily, or has been lying in the sun on a hot day, his temperature will be above normal.

**YOUR VETERINARIAN CAN HELP.** Call for advice, if your dog becomes ill. If necessary, take your dog to be examined at the veterinarian's office. The staff veterinarian at Guide Dogs is available to advise you about your puppy and to treat him, if you live nearby. Otherwise, it is best to call your local veterinarian.

Any time your puppy is treated by a veterinarian, make a note of it in your puppy records and inform Guide Dogs.

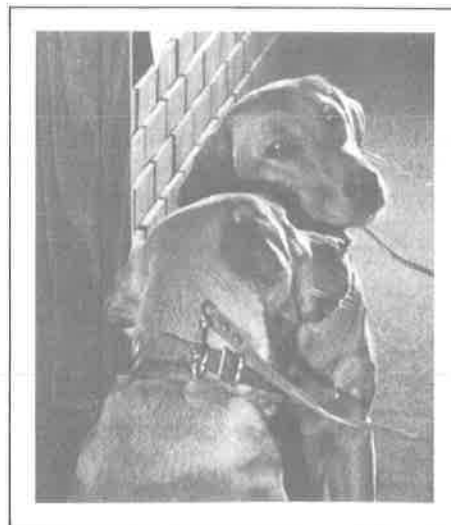

---

*"If you think he is ill, take his temperature."*

---



# Common Ailments, Symptoms, and Treatments

---

**Eyes:** Excessive discharge from the eyes, excessive blinking, squinting, or any swelling around the eyes may indicate injury or infection. Take your puppy to the veterinarian if he has any of these signs. Do not treat with home remedies, except on the advice of your veterinarian.

**Ears:** Vigorous and persistent head shaking, large amounts of wax or a foul odor in the ear are signs of ear infection. Have your veterinarian check them.

**Coughing** is usually a sign of a condition called "kennel cough." It is much like a human cold and the puppy will cure himself in about 10 to 14 days. Normally, it is not necessary to contact your veterinarian unless your puppy shows other signs that he is sick.

**Diarrhea** is a common disorder of puppies, because it is often caused by eating something which upsets the digestion. There is no need to worry unless your puppy shows other signs of illness.

If diarrhea persists more than a few hours, begin treatment by giving your puppy's stomach a rest. Do not feed him for 12 hours, but give him some Kaopectate or Pepto Bismol (liquid or tablets). Give the adult human dose, as it is not possible to overdose these products. After the fast, feed him one-half of his normal amount of food, but give him a bland diet of rice and boiled meat with salt. Keep your puppy on this diet, with plenty of clean, fresh water, until he is back to normal. Salt and water are very important to a dog suffering from diarrhea. *Do not feed any oil supplements with this diet.*

If the puppy's temperature goes above 103°F, if vomiting accompanies the diarrhea for more than a few hours, or if

blood appears in the stool, contact your veterinarian.

*Roundworms and tapeworms* are probably the most common internal parasites affecting dogs in our area of the country. Your puppy was completely wormed before leaving Guide Dogs for the Blind, Inc., but dogs can get worms again.

*Roundworms* are round and usually 2 to 5 inches long. They are sometimes seen in the stool or the puppy may vomit them.

*Tapeworms* are white, rice-like in appearance and are usually seen in the stool. Both roundworms and tapeworms can cause occasional diarrhea but they do little actual damage or harm if the puppy is well fed. If you suspect that your puppy has worms, take him to the veterinarian, along with a fresh stool sample. He can effectively rid your puppy of these parasites. Pet store medications are *not* effective.

*Hookworms and whipworms*, rare in this area, make your puppy look and act sick. Your veterinarian can detect them in a stool sample and treatment is effective.

*Heartworms* have been rare in this area, but they are becoming more common. They live in a dog's heart, after the dog has been bitten by an infected mosquito; they take 6 to 9 months to develop before they can be detected. **IF CASES OF HEARTWORMS HAVE BEEN REPORTED IN YOUR AREA, immediately** alert Guide Dogs for the Blind, Inc.

*Fleas are common.* Besides making your puppy itch, fleas carry tapeworms, cause allergies, and spread easily from animal to animal. Fleas may be difficult to see on your puppy. If your puppy has a rash or itches, eliminate the possibility of fleas even if you cannot see any.

A flea collar will help, but it will not do the job. First, bathe your puppy with a mild flea soap; then spray him thoroughly with a good flea spray. Wash and spray his bed and use the spray lightly under furniture and around the borders of the rooms. Your veterinarian has safe, effective shampoo and spray products. Continue spraying every five days until the fleas are gone, usually 4 to 6 weeks. Then, a flea collar will help prevent their return.

---

**NOTE: ALL HOUSEHOLD DOGS AND CATS MUST BE TREATED IN THIS WAY OR YOU WILL HAVE NO SUCCESS IN RIDDING YOUR PUPPY OF FLEAS.**

---

Ticks are most easily removed if first sprayed directly with a small amount of flea and tick spray. After a few minutes, slowly pull the tick free with a pair of tweezers. Ticks rarely breed or nest in the house. Your puppy will usually pick them up in brush or long grass.

*Demodectic mange* is caused by a microscopic insect which lives in the hair pores. It causes hairless patches, usually on the face or legs. These patches slowly grow larger and the skin may be red. The puppy seldom scratches. This form of mange is not contagious to other dogs or humans. It must be diagnosed by a veterinarian, and he has medications for curing it.

*Sarcoptic mange* is caused by a mite which burrows into the skin; it causes intense itching and scratching. Dogs are most commonly affected on the ears, legs, and belly. Sarcoptic mange is contagious to other dogs and to people. Your veterinarian can easily diagnose and cure this condition.

# The Making of a Guide Dog

# Rearing

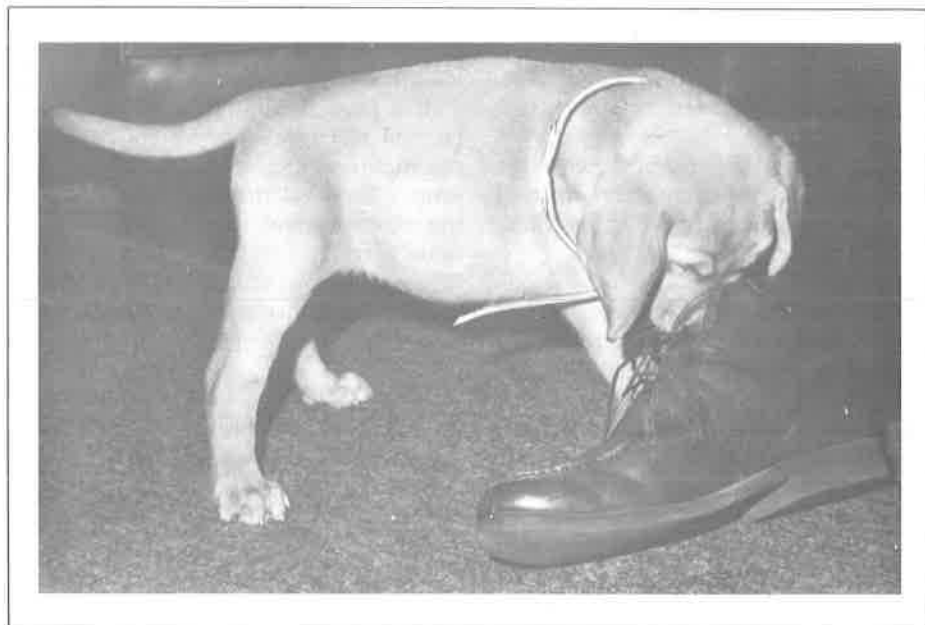

*“Teach him early in life what he can and cannot do.”*

*Housebreaking* should begin immediately. A Guide Dog will have to live in a house with a sightless person, so it is very important that he is housebroken at an early age. Housebreaking is usually simple if you remember two facts:

- 1 Dogs prefer to eliminate in a place where they have relieved before or at least on a familiar surface such as grass, gravel, or concrete.
- 2 Dogs are naturally clean and will try to avoid soiling their own beds.

As you begin your puppy's housebreaking, remember these rules:

- Take your puppy to his relieving area *before* he eliminates. Every time your puppy relieves outside he is forming the *habit* of relieving outside. But, every time your puppy has an accident inside, he is forming the habit of relieving inside.
- Do not spank, scold, or punish your puppy *after* he has an accident. It will merely teach him to hide from you after he has an accident. If you see your puppy *in the act* of eliminating in the house, tell him “no” and rush him to his relieving area outside. If you find a mess that your puppy has made in the house, all you can do is clean up and try to be more attentive.

---

**NEVER DRAG YOUR PUPPY TO A MESS AND SCOLD HIM OR RUB HIS NOSE ON THE SPOT.**

---

- Confine your puppy to his bed when you cannot pay close attention to prevent an accident. Be sure you do not confine him longer than he is able to control himself.

For your puppy to be a successful Guide Dog you must:

- (1) *Rear him.* Teach him early in life about what he can and cannot do to be well behaved.
  - (2) *Socialize* him to the world he will live and work in.
  - (3) *Protect* his well-being to assure that he will grow to be a sound working dog.
  - (4) *Train him.* Give him the joy of having a job to do and receiving praise for a job well done.
- BE CONSISTENT. Form good habits only. Do not expect your dog to guess when he may do something and when he may not. Whatever behavior

you demand of your puppy, demand it all the time: in the house, in the car, in town, and during obedience exercises. Prevent bad habits, and you won't have to correct them later.

- CORRECT PROPERLY. To correct a dog properly the correction must be given at the time, *in the act* of misbehavior. The correction must last no longer than the tick of a clock.
- BE GENEROUS WITH PRAISE, particularly following a correction. It is the best way to show your puppy when you are pleased with him and that he has stopped doing whatever brought on a correction. Your puppy will never resent a properly given correction and will come to you with wagging tail if he learns to expect praise.

Your new puppy will need to eliminate many times each day. There are several signs which will tell you he needs to eliminate, and there are also some definite times during the day when your puppy is almost certain to need to eliminate:

- 1 Immediately after awakening from a nap.
- 2 After a romp or play time. (During play the urge can come suddenly, so be especially watchful if indoors.)
- 3 Shortly after eating.
- 4 When your puppy sniffs the floor or ground intently, looking for a spot to relieve. (He may walk a little differently or suddenly interrupt doing something he seemed interested in doing.)

Pay close attention and look for warning signs. You will soon know when your puppy needs to eliminate, and it will be easy to prevent accidents. Your puppy will form the *habit* of eliminating outside and will wait as long as he can to go out because he prefers to do so.

When you take your puppy outside to eliminate, stay with him until he eliminates. If you let him out alone, you will not know whether he has eliminated. Also, you should be close by to praise him for eliminating in the proper place.

Keep your puppy in the house for at least an hour before bedtime, then take him out to eliminate just before bedtime. Do not rush him. Many dogs eliminate two or three times before they are finished.

**RELIEVE YOUR PUPPY ON LEASH.** When he becomes a Guide Dog he will need to relieve on leash. If you take your puppy to his relieving area on leash during his housebreaking period, he will remain willing to eliminate on leash.

After housebreaking, relieve your puppy on leash at least once each day and he will remember his training.

*Jumping on people* by any dog, particularly by a large dog is objectionable. When your puppy jumps up on you, firmly put his feet on the floor and praise him. If he persists, bump him to the side and praise him immediately when all four feet are on the floor. If you and your family are consistent, he will soon learn that the way to get the attention he wants is to keep his feet on the floor. (Verbally reprimand him with "no" or "get off." "Down" and "stay" should be used only in obedience exercises.)

*Getting on the furniture*, even front feet only, should be handled in the same way. Teach your puppy from the start that there is no reward for climbing onto the sofa and praise for staying on the floor. He will form the *habit* of staying on the floor.

*Stealing food* will not be a problem, if your puppy learns early that only the food in his bowl or from your hand is his. If you allow your puppy to have table scraps, put them in his bowl at his regular feeding place. **DO NOT FEED YOUR PUPPY FROM THE TABLE AT ANY TIME.**

Teach him to ignore food left within reach, such as on a counter or low table. Put a few pieces of kibble or a cookie out to tempt him. Watch closely. If he sniffs at or tries to take the cookie, bump him or correct him away from the table and praise him immediately. Repeat the lesson until he ignores the temptation. You may then take him to his feeding spot and allow him to have his treat.

*Possessiveness about food, bones or toys* must be prevented. Take them away from him regularly, praising him when he has given them up willingly and returning the object to him. If he growls or grabs at them, correct him. Praise him as soon as he waits patiently. Repeat these exercises at least once each week—more often if necessary.

*Destructiveness* in the house should be avoided in the same manner. Give your puppy a chance to explore the house while you closely supervise him. If he begins to chew anything he should not, correct him. Confine him away from the opportunity to begin chewing or bothering anything he should not have. He will form the *habit* of behaving properly.

**Remember:** Use your puppy's bed to confine him any time you are unable to watch him closely to prevent bad habits or accidents in the house. You can teach him the word "bed" by calling his name and saying the word "bed" every time you want him in his bed. If you do this before feeding and then feed him directly in front of the bed, you will speed up the learning process. *Never* use the bed as a form of punishment.

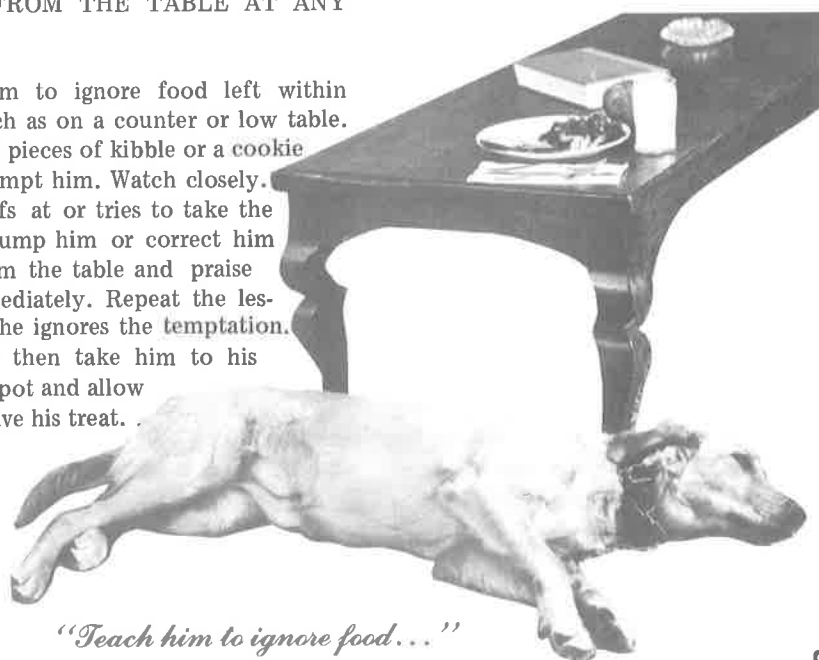

*"Teach him to ignore food..."*

# Socialization

Your puppy will guide a sightless person. Therefore, he must be capable of going anywhere without fear or hesitation.

The experiences he has during the first few months will remain with him all of his life and will decide whether he will serve the purpose for which he was bred.

Make your puppy a member of your family. He must want and need human companionship if he is to become a Guide Dog. He should be with you as often, and in as many places as possible.

Early in life and throughout his first year of life, your puppy *must* experience regularly:

- strange animals
- strange people
- crowds of people
- heavy traffic
- noisy machinery
- loud, sudden noises
- quick movements
- steps and elevators
- flags and awnings
- metal plates
- sidewalk grates

Plan regular exposure to these experiences for your puppy. You can probably think of many other important experiences.

In a new situation, you should always allow your puppy to accept the experience slowly, at his own speed. Start some distance from a noisy machine, for instance, and walk slowly toward it. If your puppy hesitates, stop for awhile, and allow him to look it over from a distance. *Never force your puppy toward*



*something which frightens him.* Calmly praise and reassure him and wait for him to become curious enough to *want* to go nearer.

When you are in a safe place—woods or a large field—let your puppy off leash for a good romp. Run with him and let him explore while you watch. Observe his reaction to something strange. He will probably look at it from several sides, eventually near it cautiously until he is satisfied it will not harm him, then suddenly ignore it, and act as though it never frightened him in the first place. When your puppy is on leash, allow him to learn about new things in the same way.

Take your puppy often in the car. Teach him to sit or lie on the floor, not on the seat. *Never allow him to ride in the car with his head out of the window;* serious eye damage can result from this practice.

Never allow anyone to tease your puppy. Teasing could make your puppy distrustful or aggressive toward strangers, characteristics not suitable to a Guide Dog. Don't allow friends or visitors to tease your dog and don't allow him to jump on them or to beg food from them. Be firm and explain that your puppy is being raised for a special purpose and that his training must never be broken.



*“Teach him to sit or lie on the floor as he will as a guide dog.”*





## Protecting Your Puppy

---

A good Guide Dog prospect's health and well-being must be protected.

A fenced yard or run from which the puppy cannot escape is essential to his safety. No dog should be allowed to run where he can possibly be hit by a car or be shot by a rancher who has found him chasing livestock or poultry on his property.

When you are asked to bring your puppy to a 4-H Club meeting or to a service club meeting or school exercise, always keep your puppy on leash and *under your control*. Friends and classmates may want to play with your puppy, but an inexperienced handler could upset weeks of good work, or worse, accidentally let him loose in an area where he could be hurt.



*"Protect his well-being..."*

---

# Training

*"...A short tug on the leash..."*



*"The joy of having a job to do..."*



*First things first.* Your puppy must learn to be "obedient." Teach the following exercises and commands in order. Be sure your puppy understands one command or exercise before you begin teaching him the next. This way, you can build on what your puppy has learned. That is, you will use what your puppy knows to teach the next exercise.

A young puppy's attention span is short. Do not expect him to be able to work at obedience exercises for more than a few minutes at a time at first. Do not ask your puppy to do anything he cannot do.

Do not ask your puppy to do anything you cannot make him do.

*Teach your puppy his name.* He has not been taught his name. That will be your job. Always address your puppy by his name, repeat it to him as you pet and stroke him, and use it to tell him that you want his attention. For instance, say "Roger," pause one second, then give the command, such as "heel," "sit," or "come."

*Teach your puppy to "walk on lead."* There will be many times when you will walk your puppy on leash but will want him to be free to explore and investigate. He should not be told to "heel" at these times. Your puppy should learn to walk on a loose lead without actually heeling.

Keep a loose leash at all times. Do not allow your puppy to develop the habit of pulling you around. Do not develop the habit of steering your puppy with the leash, either in obedience exercises or when walking your puppy on lead. The leash should be used only to give meaningful tugs, leash corrections. Learn to use your leash properly. The loop goes over your right thumb, any excess leash is held in a single fold in your right hand.

---

**NOTE:** Do not use a chain collar on a puppy less than six months old. Consult your local leader if you feel your dog needs a chain collar. Guide Dogs will provide you with a new leather collar when your puppy outgrows his old one.

---

As you walk along with your puppy, encourage him to stay fairly close to you by praising and talking to him. If the leash becomes tight, call his name and give a slight tug on the leash to get his attention. Praise him when you have his attention and continue walking. By consistently walking your puppy in this manner, he will learn never to pull on the leash and to look happily to you when he hears his name. When your puppy has learned to walk properly on leash and responds to his name, he is ready to begin learning the six basic obedience commands: "sit," "heel," "stay," "come," "down" and to retrieve.

*Teach your puppy to "sit."* While walking your puppy on leash, stop occasionally and call him to you. With him at your left side, call his name and command, "Sit." Give a short tug on the leash, straight up with the right hand, and run your left hand down the puppy's back and under his rump. Push the rear legs forward and the puppy will suddenly find himself in the sitting position. *Praise him immediately.* Try to soothe and relax him for

*...push the rear legs forward... ...the puppy suddenly is sitting... ...Praise him immediately."*



two or three seconds. If he remains sitting that long the first time, that is long enough. Continue walking and in about 15 to 20 seconds repeat the lesson. Usually the puppy will begin to get the idea after five or six repetitions, and he will begin to sit by himself.

**DO NOT KEEP CONSTANT PRESSURE UPWARD WITH THE LEASH. DO NOT TRY TO PUSH THE PUPPY'S REAR END DOWN TO THE SITTING POSITION.**

Gradually lengthen the time you require your puppy to remain sitting. If he remains sitting for 10 seconds by the end of one week, you are doing well.

*Teach your puppy to "heel" when he is "walking on lead" and "sitting" fairly well. With your puppy sitting at your left side, call your puppy's name and command, "Heel." Step forward with your left foot and encourage him to follow.*

Your puppy should be close to your left side, his shoulders even, or a little ahead,

of your left knee. To keep him in proper position, repeat the command, "Heel," and give a tug on the leash toward your left side. Your puppy should know the meaning of the tugs from "walking on lead," and he will soon learn that "heel" means to stay close to you. Each time you stop, have your puppy "sit" at your left side facing straight ahead. Since he should already know the meaning of "sit," this part should come quickly.

*Teach your puppy to "stay" when he shows that he understands the "heel" command. (Do not call your puppy's name as this prepares him for action.) Give the command, "Stay," slowly and quietly. Put your left hand, palm down, in front of your puppy's nose. This will block his way if he tries to move when you move. Slowly swing your right leg around in front of him, keeping your left palm in front of his nose, and then the left leg, so that you end up facing your puppy.*

Slowly and softly keep repeating the command, "Sta-a-a-y." After one or two



*"...close to your left side, his shoulders even, or a little ahead of your left knee."*

*“From the sitting position . . . . . move your puppy’s front feet forward with your right hand . . . . . praise and soothe him when he is lying down.”*



seconds, turn back so that he is once again on your left side and praise him. Repeat the lesson several times, each time waiting a little longer and standing a little straighter before you return to his side. When you can stand up straight and wait for five full seconds before returning to his side, usually three or four days after beginning this lesson, you may start to move away from him slightly after turning to face him. Move just one step at first, gradually increasing the distance each day until you can go to the end of the leash.

If your puppy moves when he has been told to “stay,” quickly tell him “no” with the upward tug on the leash which he knows means “sit.” Put him in the sitting position and begin again.

Teach your puppy to “come” when you are able to go to the end of the leash for at least 15 seconds on the “stay” command. Start just as you did for the “stay” command. Go to the end of the leash and after a short interval, call your puppy’s name and command, “Come.” Make the command a pleasant, happy one. He will hesitate because of his “stay” training.

Tug gently on the leash and encourage him.

As he moves toward you, direct him toward your right side by giving little tugs on the leash. As he arrives at your right side, take a step forward and pass the leash behind your back to your left hand and across the front to your right hand. This should cause your puppy to follow the leash behind you and to your left side. Have him “sit” and praise him. Repeat the lesson four or five times, then let him rest. Later, practice the “stay” command and return to your puppy so that he learns that he is only to “come” from the “stay” position when you give the command.

When he understands what “come” means you should teach him to “come” while he is “walking on lead.” This will teach him that he may have to come to you at any time, not only when he is doing the “stay” exercise.

When your dog has learned the “come” exercise, you can start to teach him to “stay” without the leash. Give the “stay” command in exactly the same manner

you have been giving it. Stop at the same distance from him, just as though the leash were still attached. Each day go a step farther from him until you are a full 10 steps away. If he is not perfect at any time, go back to using the leash and working from a shorter distance.

---

**NOTE:** Most dog training books, as well as American Kennel Club Obedience Rules, describe the “come” command to mean that the dog comes and sits directly in front of the handler. There are also different ways of moving the dog to “heel.” Use the method described here. This is the manner in which your puppy will be trained to “come” for his future blind master.

---

Teach your puppy “down” after he understands the first four commands. Start the lesson with him sitting at your left side. Kneel and give the command “down” as you move your puppy’s front feet forward with your right hand. Your left hand should be on the puppy’s back to soothe and calm him. (See illustration for proper hand position.)

Your first few lessons will be easier for you and your puppy if you take care to choose the proper time to teach him "down." Pick a time when he is calm and relaxed, rather than when he is frisky. Later, when he understands what is expected of him, you can practice the "down" at any time.

Soon, you will be able to give the "down" command by placing your right hand on the leash just under his chin and following the command with a tug on the leash, straight down. When he is lying down and is steady, stand up very slowly. He will probably sit or stand up as you do, expecting the "sit" or "heel" command to follow. Merely put him in the "down" position again. When he has remained in the down position for a few seconds, give the "sit" command. Gradually increase the length of time you require your puppy to remain in the down position. Then, begin practicing the "stay" command in both the sitting and down positions.

*Teach your puppy to retrieve.* When your puppy returns to Guide Dogs for the Blind, Inc., his professional instructor will teach him to retrieve so that he will

eventually be able to pick up and return the objects his blind master drops. You can help his future training by encouraging him to enjoy carrying things in his mouth.

Use a soft object, like a stuffed sock, for retrieving. It will have your scent and it will also be light and easy on his teeth. Get very excited about this "precious thing." First show it to him, then encourage him to grab it before you throw it a short distance. If he does not "fetch" it at once, run after it yourself and pick it up. He will soon want to beat you to it.

It may take several days before he enters into the play. When he does pick it up, ask him to "come" and start running away from him. When he follows with the sock, slow down and when he is even with you, stop and praise him. Slip one arm around him and place your other hand under his chin. Remove the sock from his mouth, saying "out." Then give lots of praise.

Be sure that the retrieving exercise remains a game. Do not force your puppy to retrieve the sock—merely try to interest him in picking it up. When he

does pick up the sock, repeat the exercise only two or three times. Stop and put it away *before* he tires of the game.

If your puppy does not want to bring the sock to you after he has picked it up, have him retrieve it on the leash so that he must come to you. As a Guide Dog he will retrieve on leash.

During the months you care for your puppy and help ensure his proper development, you will be spending many hours practicing obedience exercises. Often the mistaken impression is formed that when obedience exercises are over for the day, so is the care of the dog.

Obedience exercises are just one important part of raising a Guide Dog. The commands are valuable only if they can be applied to everyday situations. Obedience exercises require only about 30 minutes per day—raising a Guide Dog requires your attention all day.

Let obedience training help you to PROTECT, to REAR, and to SOCIALIZE your puppy. If you can achieve this, you will be proud of your puppy when he grows up to be a Guide Dog.

---

## When Your Puppy Returns to Guide Dogs for the Blind

Some time between 12 to 15 months of age, the puppy you have raised will return to Guide Dogs for the Blind, Inc. Someone from the school will call to pick him up, but, when circumstances demand, he may be shipped by air to San Rafael.

As soon as your puppy arrives at Guide Dogs for the Blind, Inc., he will be assigned to a licensed instructor, given his booster shots, and have a complete physical examination. After a few days of adjustment to kennel life, training will begin.

A Guide Dog receives five months of training before being matched with a

blind person for the final 28 days of training. The initial evaluation takes two to four weeks, but it may be a full five months before the instructors can be certain that your puppy is suited to guide a blind person. Even after completing training, there are often two to three months before a dog can be matched with the right blind person for him. (If your puppy does not respond to training, you will be notified and asked if you would like to have him as a pet.)

As soon as your puppy's graduation seems certain, you will be notified and invited to attend the graduation ceremony to present him to his new master.

Many Guide Dog users, training with a second dog, are able to complete training before graduation. In this case, you will be invited to San Rafael to meet your dog's new master before the team leaves.

Usually you will be notified about one week before graduation, which is the earliest Guide Dogs for the Blind, Inc., can be certain that a team is going to be successful, but often it is possible to give only a few days' notice. Even if it is not possible for you to meet your dog's new master, you can be assured that he will always be grateful to you for raising his dog.

# When You Meet a Blind Person

---

**DON'T** treat a blind person as if she or he were abnormal. Speak directly to the person in a normal tone of voice. Treat the person as you would any friend.

**DON'T** grab the arm of a blind person and push him or her ahead of you. Let the person take your arm or place his or her hand on your shoulder. The person will be able to follow the motion of your body to follow you. If there is an unusual obstacle, tell the person what to expect. Remember, your pointing direction is of no value to a sightless person.

**DON'T** push a blind person into a seat. Place the person's hand on the back of the seat or chair and allow the person to sit down.

**DON'T** leave a door half open. See to it that all doors are either closed or wide open, flush against the wall. A half-open door is a dangerous obstacle.

**DON'T** walk away from a blind person without telling the person you are leaving. Think how embarrassing it would be to be left talking to yourself.



*This manual was prepared originally by the late Clarence J. Pfaffenberger. It was revised in 1965, 1969 and again in 1976 by the staff of Guide Dogs for the Blind, Inc., San Rafael, California. This manual is intended for use of 4-H members who are raising puppies for Guide Dogs for the Blind.*

*Photo credits: Front cover (adult dogs), Jack Fulton; inside front cover and page 3, Joshua Freiwald; all others, Thom Ainsworth.*

*To simplify information, trade names of products have been used. No endorsement of named products is intended, nor is criticism implied of similar products that are not mentioned.*

The University of California, in compliance with Titles VI and VII of the Civil Rights Act of 1964, Title IX of the Education Amendments of 1972, Sections 503 and 504 of the Rehabilitation Act of 1973, and the Age Discrimination Act of 1975, does not discriminate on the basis of race, religion, color, national origin, sex, mental or physical handicap, or age in any of its programs or activities, or with respect to any of its employment policies, practices, or procedures. Nor does the University of California discriminate on the basis of ancestry, sexual orientation, marital status, citizenship, medical condition (as defined in section 12926 of the California Government Code) or because individuals are special disabled veterans or Vietnam era veterans (as defined by the Vietnam Era Veterans Readjustment Act of 1974 and Section 12940 of the California Government Code). Inquiries regarding this policy may be addressed to the Affirmative Action Director, University of California, Agriculture and Natural Resources, 300 Lakeside Drive, 6th Floor, Oakland, CA 94612-3560. (415) 987-0097.

Issued in furtherance of Cooperative Extension work, Acts of May 8 and June 30, 1914, in cooperation with the U.S. Department of Agriculture. Kenneth R. Farrell, Director of Cooperative Extension, University of California.

# HOW TO RAISE YOUR GUIDE DOG PUPPY



UNIVERSITY OF CALIFORNIA    AGRICULTURAL EXTENSION SERVICE



This manual was originally prepared by the late Clarence J. Pfaffenberger, former Vice President of Guide Dogs for the Blind, Inc., San Rafael, California. It was revised in 1965 and again in 1969 by Fred L. Maynard of Guide Dogs for the Blind, and William G. Schneeflock, 4-H Club Specialist, Berkeley. This manual is intended for the use of 4-H Club members who are raising puppies for Guide Dogs for the Blind.

Books to help you—available at your local library or bookstore.

*Complete Book of Dog Obedience*, Blanche Saunders  
*Dog Care for Boys and Girls*, Blanche Saunders  
*Dog Training for Boys and Girls*, Blanche Saunders  
*Living Your Dog's Life*, Romona C. Albert  
*Puppy and Dog Care*, Harry Miller

Films on Guide Dogs

<i>The Gift of Sight</i>	}	16mm color, sound, 25 minutes
<i>The San Rafael Story</i>		
<i>Courage Beyond</i>		16mm color, sound, 10 minutes

To simplify information, trade names of products have been used. No endorsement of named products is intended, nor is criticism implied of similar products which are not mentioned.

Co-operative Extension work in Agriculture and Home Economics, College of Agriculture,  
University of California, and United States Department of Agriculture co-operating.  
Distributed in furtherance of the Acts of Congress of May 8, and June 30, 1914.  
George B. Alcorn, Director, California Agricultural Extension Service.

Rev. APRIL 1969



# HOW TO RAISE YOUR GUIDE DOG PUPPY

Good health and normal growth are important in the proper development of a dog. If you follow the instructions in this manual with care, your puppy should keep well and strong and grow up to be a blue ribbon guide dog prospect.

You have been entrusted with a purebred puppy from highly selected breeding stock. This stock was specially developed to lead sightless people. This puppy has been chosen by special aptitude tests which show that he is superior in the characteristics that every guide dog must have.

Guide Dogs for the Blind, Inc., does not hold you or your parents legally responsible for your dog. But every dog lost to the program disrupts the plans to provide as many guide dogs as possible.

The Guide Dog School has made every effort to deliver your puppy to you in good physical condition. He has had enough training so that with a 30-minute training period every day, you will have a well-behaved dog from the start.

## Before Your Puppy Comes . . .

- Build a bed or sleeping box.
- Get a lightweight chain with at least one swivel on it.
- Provide a suitable dish for his food and one for his water.
- Be certain your yard fence is dog-tight, or build a run.
- Get yourself a stiff brush and a comb.

## . . . After Your Puppy Arrives

1. Give your puppy time to relieve himself before you take him into the house. Choose the place where you want him to go and take him there right away so that he will know and accept it.
2. Give him food and water—then let him rest.
3. Be certain to start training your puppy the second day. Begin by teaching the 6 basic exercises: come, sit, down, stay, heel, fetch. These exercises are important because they are the commands taught in guide dog work and used by the blind person. If there are classes for guide dog raisers near your home, you are encouraged to attend.
4. Use the leash and collar given to you.

## HEALTH, SAFETY, AND HAPPINESS

### PREVENTION SHOTS

Your puppy has had shots to prevent distemper, hepatitis, and leptospirosis. But he has not had shots for rabies. When your pup is 4 months old, have your veterinarian give him his rabies shot. Send the bill for the shot to Guide Dogs for the Blind, Inc., San Rafael, California. These shots do not mean that your dog cannot get these diseases. Do not expose him to any disease.

Your puppy has been wormed, but he can get worms again. If you think your puppy has worms, call your veterinarian and follow his advice.

### **VETERINARIAN CAN HELP**

If your dog becomes ill, call your veterinarian for advice. If necessary, take the puppy to his office.

Whenever it is necessary to consult a veterinarian about your puppy's health, call Puppy Placement Department, Guide Dogs for the Blind, Inc., San Rafael, California. The telephone number is (415) 479-4000. The switchboard is open from 9 a.m. to 5 p.m.

If your puppy is a female, place her in a veterinarian kennel as soon as she comes in season and leave her for 3 weeks. Guide Dogs will pay the bill. If you live within a 50-mile radius of San Rafael, Guide Dogs will board the puppy. Your puppy should come in season when she is between 6 months and 1 year old. **DO NOT HAVE HER SPAYED.**

### **A RUN FOR YOUR PUPPY**

A fenced yard or run from which the pup cannot escape is essential to his safety. No valuable dog should ever be allowed to run where he is likely to be hit by a car.

The idea that a dog should have a quarter acre to run on at will has long been abandoned. Today we know that if a dog is given 15 minutes of brisk exercise and training twice a day and a lot of love and understanding, he can live the remainder of the day comfortably in his yard and in your house.

When you are in a safe place, like the woods or a large field, let your puppy enjoy a good run. Run and romp with him, but do not let him wander wherever he wants. Never let him

chase livestock or poultry. A few fine puppies have been shot because the puppy raisers did not keep them under control and neighbors found them chasing livestock and poultry. When you are through with play, put the leash on the puppy and lead him home.

If you do not have a fenced yard, build a run at least 6 or 8 feet wide and 15 to 20 feet long. If you put your puppy in the run when you first get him, he will become used to it and you will not need anything heavier than turkey wire to keep him inside. If you let him grow big before you build his run, you may have trouble keeping him in, even if you use heavy wire and a high fence. So, start right.

Naturally, you should never leave your puppy outside in bad weather. Build a good shelter to protect him from rain or hot sun. He should have a bed in a dry, draft-free room to use at night and when the weather is bad.

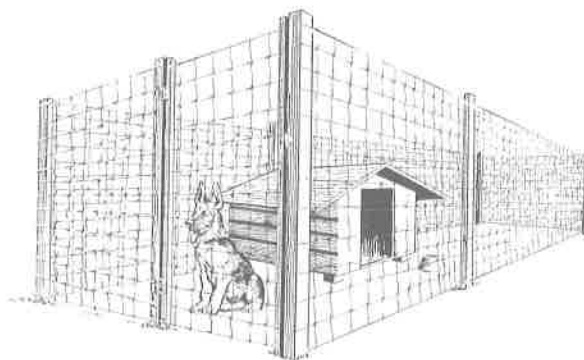

### **CLEANLINESS IS IMPORTANT**

Do not bathe your dog too often because soap and water remove the natural oil that his hair needs. A brisk brushing every day is better than a bath.

If your puppy gets a small area of his body dirty, you can clean him with a damp cloth. If you have to bathe him, don't get water and soap in his eyes. To keep water from running into his ears, tuck a little cotton in each ear before washing. Remove the cotton as soon as you finish.



To keep his ears clean, wipe them with a damp cloth once a week. Dirty ears cause many troubles and encourage ear mites. The ears can become so seriously infested that there is no cure, and it may be necessary to have a dog destroyed.

The eyes should also be kept clean by wiping with a damp cloth. If they are injured, or show a discharge, consult your veterinarian. Allowing a puppy to ride with his head out of a car window can cause serious eye injury.

The care you give your puppy will help keep him healthy. Good grooming throughout the year may also help to win a blue ribbon or a trophy at the Guide Dogs for the Blind Field Day held each August at San Rafael.

## LET HIM GROW UP WITH THE FAMILY

Dogs need mental exercise as well as physical exercise. While your dog is growing up, take him in the house, let him ride in the car, take him into town on a leash and let him become used to people, other animals, noise, and traffic.

In the car, he should sit or ride on the floor, never on the seat. Encourage him to be friendly with people and with other dogs.

Your leader may want you to bring your puppy to 4-H Club meetings. You may be asked to appear at service club meetings and at school exercises with him. Always keep him on a leash at such affairs and always keep him under your control. Your classmates will want to play with him. Remember—an inexperienced handler might upset the good work it has taken you weeks to accomplish, or let him loose in a dangerous area where he could be injured or killed.

## SOCIALIZATION

The most important thing for you to remember when you raise your guide dog puppy is the use for which he will be needed. This use—guiding a blind person—requires that your puppy be capable of going anywhere his master wishes, without fear or hesitation. If he is going to be able to do this, it is important that he become “socialized” as he grows up. Socialization—the complete development of basic soundness in your dog—must begin immediately and be continued throughout your guide dog project.

As you read your manual you will notice the many different things that are necessary in caring for your puppy, like feeding, house-breaking, obedience training, and good manners. These things are the beginning of your puppy's social development and usually begin

at home. However, it is also very important that your puppy be exposed to situations outside his home area. He should have the experience of meeting such things as strange animals, other people, heavy traffic, loud noises, quick movements, different buildings, steps and elevators, flags and awnings, metal plates and grates, automobile rides and other normal every day activities. You should, of course, consider your puppy's age and introduce him to these situations with that in mind.

During the months you care for your puppy and help insure his proper development, you will be teaching the basic obedience commands many times. Often, in the latter months of training, a mistaken impression is formed about the project. This is the idea that when the few minutes of obedience training are over for the day, so is the care of the dog. While these exercises are extremely important, this is a serious mistake because they are just one part of a totally socialized dog. The commands are valuable only if they can be applied to normal every day situations. The obedience exercise seldom requires more than 30 minutes a day—socialization requires your attention all day long. Let the obedience training help you control your puppy while you are teaching him socialization. If you can achieve this, your puppy will grow up to be a guide dog for which his blind master will always be thankful.

## **BASIC TRAINING**

### **THE SECRET OF SUCCESSFUL DOG TRAINING**

All successful dog trainers, amateur and professional, know the secret of training and use it. If you use it, training your puppy will be easy, fun, and your puppy will learn quickly.

What is this secret? Just 2 words—"Be Consistent." Always use the same word for the same command. Always require your puppy to do the same thing in the same way.

This secret of consistency applies to all the training you will give your puppy. Be consistent in feeding—select convenient morning and evening hours like 7:00 a.m. and 5:00 p.m. Abrupt changes will confuse your puppy, affect his regular habits of elimination, and may make him sick.

In training your puppy to come, sit, stay, down, heel, and fetch, always use the same commands. Always insist on good performance, correct him until he does it right, and praise him when he obeys. In this way you are being consistent.



If you take your puppy into the house after playing with him outdoors and he still wants to play, insist on good house behavior. Attach the leash and make him heel, sit, and stay. In this way he learns good manners and he will be loved and accepted by your family. This is being consistent.

A well-mannered guide dog reflects your consistent attention to details. You train him to stay off furniture, beds, and automobile seats.

He is not fed tidbits from the table. He does not jump on people. He is prevented from fighting. Your early training, followed by the training he will receive when you return him to Guide Dogs for the Blind, will help make him a well-mannered, obedient companion for his sightless master.

Be consistent in your demands, in your correction, and in your praise.

Don't ask your puppy to do anything that he cannot do.

Don't ask your puppy to do anything that you cannot make him do.

### **PRAISE—THE BEST REWARD**

Praise, stroking, and petting are the best rewards you can give a puppy for obeying commands. Never punish a puppy. If you are present when he does something wrong, you can correct him. Scolding and preventing him from going ahead with the wrong thing will have the desired effect. If a dog needs punishment, someone is to blame for allowing him to develop a bad habit.

### **NEVER TEASE A PUPPY**

It is not necessary to tell a 4-H Club member never to tease a dog. But it is possible that someone who does not know this may visit you at some time. If so, be very firm. Explain to your visitor that this dog is valuable, that he is becoming a guide dog, that teasing makes any dog mean and that a mean dog can never be trusted with a blind person. Guide dogs should be friendly with everyone. An overprotective dog does not make a suitable guide.

### **HOW TO HOUSEBREAK YOUR PUPPY**

A guide dog has to live in the house with his master. It is very important that he be housebroken at an early age. Housebreaking a puppy is quite simple, and it is a very fine accomplishment on the part of the puppy raiser.

Here is how you do it. Make a simple bed of plywood or other wood, or use a wooden box. Because your pup will grow very fast, it is better to make the bed large enough for him when he is full grown. There should be 3 sides 10 or 12 inches high to keep out any draft. The fourth side should be open. The floor of the bed should be smooth so that nothing will injure the dog while he lies on it. A plywood bottom "gives" just enough to be comfortable for a dog. The bed should have legs at least 3 inches high to allow circulation underneath.

Insert an "eye" screw in the wall behind the bed so your puppy can be chained. Use a lightweight chain about 1½ times as long as he is. This allows the puppy complete freedom while on the bed and permits him to get off the bed but not to go very far. The chain should have at least one swivel to prevent the puppy from becoming tangled in it. Take your puppy outside at bedtime to eliminate.



Then place him on the bed, snap the chain into his collar ring, and let him sleep there.

When you take your puppy out to eliminate, stay with him until he has eliminated. If you let him out alone, he may want to come in before he has eliminated, just to be with you. If you leave him out a couple of hours before bedtime, you have no assurance he has eliminated. If you have him inside at least an hour before bedtime and then take him out, he is almost sure to eliminate quickly. Do not rush him. Most dogs' bowels move at least twice before they have completed elimination. When your dog is 8 months old, it is important to teach him to eliminate while on leash.

A dog likes to eliminate in the same area he has gone before. You will save much time if you take him directly to this place. If he has an accident in the house, mix a little sand or soil with the eliminated matter, take this soil where you want the dog to go and leave it there. Take him back to this place when you want him to go and you will soon establish this habit. Be sure to use some disinfectant to clean the spot where he eliminated in the house so he will not use it again.

The bed may be used any time you want the puppy in the house but don't want him to wander around. It is quite simple to teach him the word "bed." Call his name and say "bed" every time you want him on the bed. If you do this before feeding and then feed him directly in front of the bed, you will speed up the learning process. Naturally, the bed should never be used as punishment, nor should the dog be kept there day and night.

### **LEASH CAN MEAN A GOOD TIME**

The puppy is delivered to you with his leash and collar. Leave the collar on him at all times. Be sure to loosen it as he grows. If

he outgrows the collar, measure it and send the measurement to Guide Dogs for the Blind, Inc., San Rafael, California, Attention: Puppy Placement Department, and ask for a larger collar.

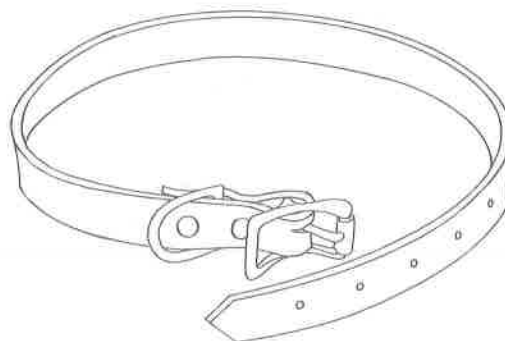

Do not use a chain training collar on puppies less than 6 months old. If the puppy is properly trained, he will be so well educated by the time he is 6 months old that a chain training collar will be unnecessary.

By putting the leash on the puppy to take him with you and to bring him home, you teach him to associate the leash with a good time.

Talk to him as you walk along—like you would talk with a child. He will not understand all you say, but he will enjoy the attention and eventually will understand many words.

You will use the leash only when you are training the pup, or taking him for a walk or a ride. Do not tie him up with it or let him run dragging it. Leave it on when you take him for a ride in a car, as a safety measure to control him.

Your leash has a loop in one end and a snap on the other. Snap it on the collar ring and hook the loop over your right thumb. Let the leash fall across the palm of your right hand and grasp it. Fold any excess length in your hand. Keep the leash as slack as possible and encourage the puppy to walk with you

where you want to go. If he wants to go another way at first, walk his way a little, encourage him, and when he is started, go your own direction and he will follow. Soon you will have the puppy walking with the leash hanging slack and his shoulders about even with, or a little ahead of, your left knee. This is the way he should heel as a future guide dog.



HOLDING THE LEASH CORRECTLY

### TRAINING YOUR PUPPY TO HEEL

Your puppy has not been taught his name. This you will have the privilege of teaching him. Always address the puppy by his name. For instance, say "Roger," count to 3 under your breath to give him time to respond and give you his attention. Then, give the command, such as "heel, sit, or come."

Before you give your puppy the command to heel, have him sit at your left side. He must sit close with his head straight to the front. He has had one lesson a week in this for 5 weeks during his tests and already heels quite well. When you are ready to start, get his attention by calling his name. When he looks up at you, command "heel," and at once step forward at a brisk pace with your left foot—always your left foot—first. Keep your pup close to your side with his shoulders even with your left knee or just a little ahead of it. Do not let him get far enough ahead to try to cross over in front of you. Go forward, make right turns, left turns, and about-turns. While you are teaching him, talk to him and encourage him by telling him how well he is doing. If he does wrong, say "no," and show him what you want him to do.



Here are some tips about those turns you are going to make. Many people make awkward turns and foul their dog in the leash, or cause him to tighten the leash, because they do not give him a chance to come around with them. Try this—when you make a right turn, make it when your left foot is out in front in a normal step and your right foot is still touching the ground. Rise up on both toes and pivot to your right. This will give your pup time to come around and continue with you at a regular pace. When you have made a turn, keep on walking.

To make an about-turn, pivot on your toes exactly the same way but turn completely around to your right so you are facing in the opposite direction.

To make a left turn, start when your left foot is out front and use your right knee to spin you around as a counterbalance. A little shove with your right foot starts you around and the weight of your right leg, with your knee forward, brings you to a left face. The knee also blocks the progress of your pup so that he has to turn with you.

Practice these turns by yourself in your yard or a large room. When you can do them well, start teaching your pup to heel when you

turn. Each time you stop, which should be quite often, call your puppy's name and say firmly, "sit." Make sure that your puppy does sit.

### TEACHING YOUR PUPPY TO SIT

When you receive your puppy, he has already been given some lessons in sitting. You should continue teaching your puppy to sit. Begin with the puppy on your left side and place your left hand over his hips, holding the leash with your right hand. As you give the command "sit," push gently down on the puppy's hips and give a very slight upward tug on the leash. Let the puppy sit for a few seconds so that he understands the lesson. Be sure to praise him for obeying the command.

If the puppy does not obey, it may be because you are strange to him. Always follow the method described above and teach him that he must also mind you. Soon he will learn to sit at either the hand signal or command. Once your puppy is minding your "sit" command, have him sit every time you start an exercise and every time you stop one. He should always sit on your left.

Forward—left foot first



Left turn—pivot on left toe



About-turn and right turn—pivot on both toes



Stay—start with right foot first

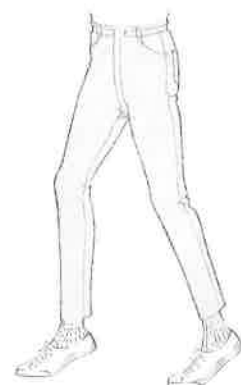

### LEARNING THE TURNS





TEACHING PUPPY TO SIT

### TEACHING YOUR PUPPY TO STAY

Start with your puppy in the sitting position and give the command, "Roger, stay." You should always carry your leash in your right hand. This leaves your left hand free to perfect the "stay" command.

This is how you do it. As you give the command, make a left turn just as you did in teaching your puppy to heel. But on the command "stay," place your left hand directly in front of the puppy's nose with the

palm toward him and hold it there while you pivot. Swing your right knee to block his forward progress in case he tries to go ahead. You will stop directly in front of your puppy. Withdraw your left hand gently so you don't startle him and make him move. Stand a short time, then walk directly to his right side, holding the leash loosely, and stop in the same position from which you started. As soon as you have returned, get down on your knees and praise the puppy with a lot of petting and kind words.



After a day or two of this, face your pup and back a step away. Hold his leash loosely. You should have him sitting steady while you back away as far as possible, still holding the leash. Stand there a short time. If, after 7 or 8 days' training, he does not move when you back away 2 or 3 steps, you are doing very well. If he does move, bring the leash up sharply under his chin and say "stay," always following the same procedure.

Now, instead of holding the leash, lay it over his back. By the time you have reached the point where you can back 10 steps away with your pup steady, he should stay when you increase the distance.

After a while, time yourself to be sure that he will remain sitting while you are away for at least 1 full minute. When you return to him, always come directly to his right side, exactly where you left him. Stand there for a little while so he will remain steady, then praise him.

### **TEACHING YOUR PUPPY TO COME**

Once you have the "sit-stay" training accomplished, you will be ready to practice the "come" exercise. At first, start just as you did on the "stay" command. With leash attached to his collar, tell your puppy to "stay" and walk to the end of the leash. Turn and face him and, after a short interval, command "Roger, come." Make this command a very pleasant, happy one. If he hesitates because of his "stay" training, bring him to you gently with the leash, encouraging him all the time.

As he comes to you, you will have to help him. Pulling gently on the leash, bring him to your right side. As he clears the way for you, take a step forward and at the same time pass the leash behind your back to your left hand and across the front to your right hand. This should lead him back to your left side. Have him sit there for a little while and then praise him. Three or 4 lessons a day will be all you should give of this exercise. Continue until he minds all these commands, without any help from the leash.

When your dog has learned the "come" exercise, you can start to teach him to "stay" without the leash. First, stand about where you have been stopping when you were using the leash. Day by day, go a step farther until you are a full 10 steps from him. If he is not letter-perfect at any time, go back to using the leash and working the shorter distance.

Note: Many persons in obedience training have their dogs come to heel in a different manner from that described here. We ask you to use this type of "finish" because a guide dog must go from right to left behind the blind person so that he will not trip him.

It must always be pleasant for the puppy to come to you. When you command "come" and the puppy obeys, be very generous with your praise. The puppy may not hear you on the first command, or he may be interested in something else, so repeat the command until the puppy obeys. Again use lots of praise.

### **TEACHING YOUR PUPPY "DOWN"**

Start with your puppy in a sitting position at your left side. Kneel and hold your puppy's front feet. Pull them forward and give the command, "down." Hold the puppy in place until he remains steady. When your puppy is steady, try standing up. If your puppy gets up also, repeat "down."

After your puppy learns what is expected of him when you say "down," try giving him the "down" command by placing your right hand on his leash just under his chin and pull the leash down, giving the command "down." This should be done while he is on your left side. If he remains down after you stand up, wait a few seconds, slap your left side with your left hand and say, "Roger, sit." If he does not sit, pull the leash up and repeat the "sit" command.

### **TEACH RETRIEVING FROM THE FIRST DAY**

A guide dog must pick up and bring to his master any object his master drops. It is desirable for him to enjoy carrying things in his mouth. Your puppy has been given retrieving lessons, but constant practice is

necessary. Give him retrieving lessons daily from the time you get him. A dog toy or ball in his yard will encourage him to carry. However, do not use this for the retrieving object during his lessons because it is his toy.

Use a soft object for retrieving, like a stuffed sock. It will have your scent and it is also light and easy on his teeth. Get very excited about this "precious thing." Show it to him first. Encourage him to try to grab it, then throw it a short distance. If he does not "fetch" it at once, run after it yourself and pick it up. He will soon want to beat you to it.

It may take several days before he enters in the play. When he does pick it up, call "Roger, come," and start running away from him. When he follows with the sock, slow down gradually until you are even with each other. While speaking to him softly and praising him, slip one arm around him, place your other hand under his chin, and remove the sock from his mouth gently, saying "Roger, out." Then give him a lot of praise.

Have him retrieve once the first day, twice the next, and increase gradually up to 5 times a day but never more than that. Make it a game.

To polish off the training, teach him to come to you with the sock, sit on your left side as he does in the "come" exercise, and let you take the sock out of his mouth, without a struggle. Say "Roger, out." Then praise him.

In both the retrieving and come exercises, once your pup has learned to come around to your left side, do not step forward. Stand still and have him heel.

If your puppy does not want to retrieve the sock and bring it directly to you, have him retrieve it on the leash so that he must come

to you. When he is a guide dog, he will always retrieve while on a leash.

Any of the breeds, including the Shepherds, seem to benefit from being taught to retrieve from the water. Swimming is good exercise and a puppy that learns to "fetch" an object from the water soon brings it more readily to the handler, even on land.

## **JUMPING ON PEOPLE**

Dogs should not be allowed to jump on people. The best way to prevent this is to teach your pup the word "no." Whenever he jumps on any member of the family, that person should take the pup's front paws in his hands and gently step on the pup's hind toes while commanding "no." Do this every time your pup jumps on someone. In a week, the habit should be broken so that only the word will be necessary to prevent any future attempts. We teach the blind students to use the word "no" as a corrective word because the words "stay" and "down" are used in the obedience exercises to mean a certain action.

## **FEEDING INSTRUCTIONS**

### **FEED AT REGULAR TIMES**

Feed your puppy in both the morning and the evening. An early evening feeding is best so that the puppy will have time to eliminate before bedtime.

Use the food and feeding instructions that are given to you when you get your puppy. For the first 3 days, feed him kibble only. After 3 days, start adding meat or meat trimmings from the table and a teaspoon of bacon drippings, if you have them. We feed  $\frac{1}{2}$  pound ground beef daily, but canned horse-

meat is satisfactory. Once a day, add 1 teaspoon Vionate and 1 teaspoon cod-liver oil to the food. The food will have a better flavor if the meat is added to the dry kibble and mixed with it before the hot broth or water is poured over it.

A poached egg twice a week, instead of the meat, is very satisfactory. However, raw eggs are difficult for a dog to digest.

Canned fish, like mackerel which is very good, may be substituted for meat. Never give your puppy home-cooked or raw fish because he might get bones caught in his throat.

Never feed your puppy chop, chicken, or steak bones because they splinter and can puncture the intestinal wall or stomach. Although pups like to chew on large, raw leg bones, they are not necessary to their welfare. If you have a dog of your own besides the puppy, you can start a dogfight by giving them bones.

You can judge the amount of food the puppy should have each feeding by the amount he cleans up in 15 minutes. If he leaves food, cut down the amount. If he cleans it up quickly, add a little until you are feeding all he will eat. He should always have as much as he will eat twice daily until he is 1 year old.

By the age of 9 or 10 months, if your puppy does not eat readily when given his second meal, this indicates that one meal a day is

enough. However, a change of environment, water, or food will sometimes cause a puppy not to eat at first.

Provide clean cool water daily so the puppy can have all he wants at any time.

### **YOUR PUPPY LIKES CLEAN DISHES, TOO!**

Wash and scald your puppy's food dish after each meal to prevent poisoning from algae or fungi. Scrub and scald the water dish at least once a week.



USE A BOWL SUCH AS THIS

### **IN CASE OF DIARRHEA**

For a mild case of diarrhea, give 1 tablespoon of Kaopectate 4 times daily. This can be purchased at any drugstore. If the diarrhea continues, use 1 cup boiled rice and meat for 2 days. If there is no change, consult your veterinarian. Sometimes whole milk will cause diarrhea, so use canned or powdered milk

Sleep your puppy in a warm dry place free from drafts, and feed at regular times.

## **YOUR PUPPY'S RETURN TO GUIDE DOGS**

At about 1 year of age the puppy you have raised will go back to Guide Dogs for the Blind, Inc., in San Rafael, California. He will be assigned to one of the young men who are professional guide dog trainers. All the basic training you have given your pup by following this manual and your leader's instructions will have a great influence upon the success of the specialized training your puppy will now receive. He will be a better dog than he could have been without your help. Usually, someone from the school will come for your puppy. However, when distances are too great, weather is too bad, or when there is only one dog in a community, the dog may be brought in by common carrier.

As soon as your puppy arrives at the school, he has his own kennel where he is isolated for about 2 weeks from other dogs by a partition inside and wire outside. This is to protect him from getting any disease that another dog might bring into the kennel. During this time he is placed in training, usually the day after he arrives. He is kept in the kennel at night and when not at work.

We cannot tell you exactly how long it will be from the time your puppy comes back to Guide Dogs until he graduates, because we never know. So many things can happen. If a dog develops an illness or lameness after he starts training, he may be out of his class long enough to have to wait for the next trainer. Even after he has completed his training, he may not be suited to the personality of any member of the class of blind who have come in for training and so may have to wait for a later class. Through no fault of his own, a dog may be in training several months before he finds his proper place. Even after that, his blind master may get sick and have to go home without a dog, and the process of placing your puppy starts all over again.

Usually your puppy will graduate within 5 months after he returns to Guide Dogs for the Blind, Inc. However, it may take longer.

If a puppy does not respond to training, we notify you at once and ask if you would like to have him returned as your own dog.

### **GRADUATION TIME**

As soon as we feel certain that your puppy is going to graduate, we invite you to come to present him to his new master at the graduation. We send the invitation at least 1 week before graduation. That is the earliest that we can be sure.



## WHEN YOU MEET A BLIND PERSON

If you study and follow these simple **Do's** and **Don'ts**, your visit with a blind person will be pleasant and interesting and your attitude will help to put him at ease.

**DON'T** treat the blind person as if he were abnormal simply because he is blind.

**DO** treat him as one of your friends. He is as normal as they are.

**DON'T** touch a blind person without speaking to him first.

**DO** speak in a normal tone of voice and speak directly to him.

**DON'T** grasp the arm of a blind person and push him ahead of you and try to lift him off his feet.

**DO** let him take hold of your arm. The motion of your body usually tells him what to expect. In narrow passages or aisles where this rule cannot be practiced, you should walk ahead of the blind person and let him follow. Tell him his location and direction. Be sure not to say "left" when you mean "right." Remember—a pointed finger is of no value to him.

**DON'T** walk away from a blind person without telling him you are leaving.

**DO** think of how embarrassed you would be if you were caught talking to yourself.

**DON'T** leave a door ajar in any area where there is a blind person present. A half-open door is the most dangerous obstacle blind people encounter.

**DO** always see to it that a door is either closed or wide open, flush against the wall.

**DON'T** push a blind person into a seat.

**DO** place his hand on the back of the seat or chair and he will seat himself.

## BREEDS OF DOGS USED AS GUIDES

German Shepherds have long been considered a breed suitable to guide the blind. We have found that the Retrievers are also very satisfactory. Our own strains of German Shep-

herds, Labrador Retrievers, and Golden Retrievers are now being bred, tested, raised, and trained for Guide Dogs for the Blind, Inc.

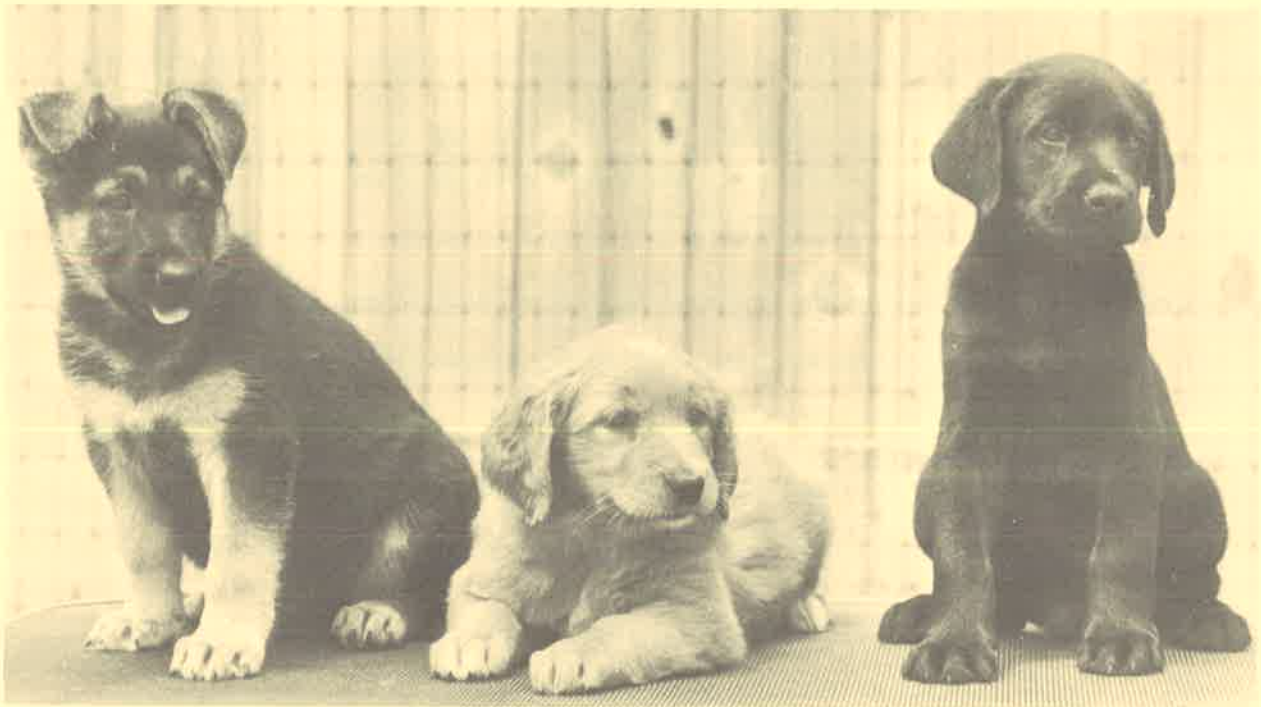

BREEDS USED FOR GUIDE DOGS ARE FROM LEFT: GERMAN SHEPHERD, GOLDEN RETRIEVER, AND LABRADOR RETRIEVER.



# GUIDE DOGS FOR THE BLIND, INC.



*4-H Leaders' Manual*







# GUIDE DOGS FOR THE BLIND, INC.

P.O. BOX 151200 ■ SAN RAFAEL, CALIFORNIA 94915-1200 ■ PHONE (415) 499-4000 ■ FAX: (415) 499-4035

BOARD OF DIRECTORS:

Bruce C. Benzler, Chief Executive Officer

Ralph J. Rasmussen  
President

James Young  
First Vice President

Mrs. J. Harold Dollar  
Second Vice President

Mrs. Gordon Cuneo  
Secretary

Lyle L. Hoover  
Treasurer

Mrs. Johan F. Blokker

Mrs. Malcolm T. Dungan

Sister Ann Gelles

Herbert S. Kaufman, M.D.

Michael R. Kluse, D.V.M.

John W. McFarland

Mrs. Neal A. Peterson

Mrs. John D. Relfe

Lt. Gen. Elvy Roberts (Ret.)

Charles W. Robertson

Joseph W. Rogers

Alex Rynecki

Richard M. Sangster

Harry H. Scott

Hezekiah H. Singleton

William G. White

MAR 23 1992

Dear Leader/Extension Agent,

The long-awaited 4-H Leaders' Manual for our Puppy Raising Project is now ready and we are proud to send you your personal copy.

Much research, many hours, and contributions of many people have gone into this manual. Although it is our first endeavor, we anticipate that it will be effective for a long time. The format we used readily permits addition, revision, or deletion of material to keep it current. We hope you enjoy it, and -- more importantly -- we hope it is of use to you.

This manual was written for use by Project Leaders involved in the Guide Dog Puppy Raising Project. You may copy part or all of it for your Assistant, Junior or Teen Leader(s). However, WE DO NOT WISH TO HAVE THIS MATERIAL USED FOR PUPS RAISED FOR OTHER DOG GUIDE OR SERVICE DOG SCHOOLS.

The manual is meant to be a guideline for you. Please share with us comments, suggestions or recommendations you have for improvement.

Thank you for ALL that you do for our program.

Sincerely,

GUIDE DOGS FOR THE BLIND, INC.  
4-H Puppy Placement Department





## INTRODUCTION

*Welcome to what is probably the most challenging and rewarding project in 4-H for both members and leaders. It may test your patience, but surely will provide a sense of accomplishment, hours of fun and entertainment, and an opportunity to help others better themselves.*

*The objectives of the Guide Dog Puppy-Raising Project are to develop a self-confident, well socialized and behaved dog and through this process develop a self-confident, well-rounded person. The 4-H motto of pledging Head (knowledge), Heart (attitude), Hands (skills) and Health (habits) applies equally to puppies and puppy-raisers.*

*This manual is designed to assist you with various aspects of the project, but not necessarily the intimate details of raising a puppy. Other material is readily available to you for that purpose, and is referred to in this manual.*

***This manual is arranged into four sections:***

- *Your Responsibilities to Guide Dogs for the Blind.*
- *Your Responsibilities to your club.*
- *Guide Dogs for the Blind's Responsibilities to you.*
- *Youth Development through Guide Dog puppies.*





## RESPONSIBILITIES TO GUIDE DOGS FOR THE BLIND

**T**HE PROJECT LEADER is the coordinator and liaison person who assists in all phases of the Guide Dog puppy care and training, works directly with the raiser, the family, the county extension agent and the school in San Rafael.

Many resources are available to facilitate your function. Guide Dogs for the Blind makes much of this available, free of charge upon request. The following is a partial list:

- The training and care manual "HOW TO RAISE A GUIDE DOG PUPPY."
- Application to raise a pup — for 4-H member and adult.
- Pamphlets pertaining to different aspects of the overall program.
- Many states have legislation pertaining entrance by Guide Dog puppies into public buildings. You may get a copy from G.D.B. or the local library.
- Manual #4H-1111, "THE VOLUNTEERS 4-H HANDBOOK."
- The book, "THE KNOWLEDGE OF DOG BEHAVIOR" by Clarence Pfaffenberger. Available at your library, through book stores or by mail order.

Guide Dogs for the Blind conducts yearly training sessions for leaders in each separate state. You will be notified well in advance and should make every effort to attend.

Keep on hand extra copies of the applications and the puppy raising manual, as well as other Guide Dog pamphlets, so you can start an applicant in the proper direction.

### ***Application / Home Visit***

When a person asks about or applies for raising a Guide Dog puppy, arrange to do a home interview. This is the **FIRST** and **MOST IMPORTANT** step in considering a puppy-raiser. Make sure the whole family is present for the interview as this project inevitably will involve all members, not just the person applying.

### ***Suggestions for conducting the interview:***

- Bring along an assistant, Junior or teen leader. Two objective views and opinions are better than one.
- Take with you one of the pups in the project, observe the family's attitude and the family pets' reactions to it.
- Bring two copies of a check list that you and the family sign, one for your files, the other for their reference (suggestions for a check list are in the back of this manual or you may design your own.)

### ***Items to check into and discuss:***

- Discuss and make it clearly understood that the pup **MUST** live in the home and sleep inside, preferably in the raiser's bedroom. Make sure there is enough room in the home and yard for the pup which is going to become a large dog.
- The home **MUST** have a fenced yard or run for the pup when the family has to leave it unattended. Even if they live in the country on acreage there needs to be a secure place for the pup. For example, a run can be a 4 ft. by 12 ft. securely



fenced area with flooring of gravel, cement, shavings or other material that can be kept clean. Puppies need a clean, healthy area.

- Check the house and yard for general cleanliness. The yard should be free of such things as broken glass, boards lying around with nails in them that pup could step on, chemicals stored improperly, garbage, etc.
- Check out what type of decor the house has. If there are a lot of knick-knacks around, expensive items, furniture or floor coverings, etc. that could be damaged, you may want to discuss moving these to a higher level or placing them elsewhere out of puppy's reach. Point out that anything within tail level may get knocked off and damaged, and that puppies like to chew. A baby gate can be used to keep puppy out of places such as the living room when the family cannot watch and control it.
- Look at the condition of the family pets. If they are well cared for, in good condition and happy, this should indicate that the family will take good care of the puppy. If their pets are not visible, ask for them. If they are reluctant to have you meet their pets, you should question why.
- Watch the behavior of the potential raiser during the interview. If he/she asks questions and seems to be attentive, it suggests a true interest in the project. If he/she is restless or preoccupied he/she may not have the patience to be a successful raiser.
- Discuss what training the pup will need: housebreaking, basic obedience, socialization and good manners. Stress that this is not to be a "show dog" or expected to become a perfect "obedience dog". Pup is to be well behaved, obedient, social, loving, happy and fun to have.

- Discuss the family's financial responsibilities for the pup (food, minor vet bills, grooming equipment and supplies, going to meetings and activities.)
- Explain that this has to be a family effort. The primary responsibility for the pup is the raiser's, but Mom and Dad have to get involved and be willing to give their time and attention to the project. Explain how much time raising this pup is going to take.
- Be honest about what having a pup in the home is really like; that YES, it is going to have accidents in the house, and that it is going to do things like chew up Dad's favorite boots, track dirt in on its feet and leave dog hair on the carpet and furniture. Guide Dog puppies are just like any other pups. They are not different just because they are a "Guide Dog Puppy".
- If the applicant is an adult, non 4-H member, make sure that he/she understands that you expect them to be as involved with the program as the 4-H raisers are, and that the rules apply to all raisers equally.
- The pup should not be left alone for long hours during the day, especially in the early months. If this is not practical, discuss delivery at start of summer vacation.



You are asked to judge the suitability of the raiser, the family and the environment, and make a recommendation to Guide Dogs for the Blind. Care must be taken not to reject an applicant because of a different life-style, or an un-kept house, etc. A leader should exercise discretion and good judgement in applying the above considerations.





There may be no clear cut answer to the suitability of an applicant. You may need to rely on your gut level feeling and information or opinions from others (project leaders, extension agents, etc.).

Should you have real doubts on approving an application, but find it difficult to tell the family, contact Guide Dogs for the Blind. Provide the school with all the information and they will make the decision and notify the applicant.

Once the decision has been made by you (and the other leader) that this is a good environment for a puppy, and the family wants to participate, have the application completed and signed by all parties, and send it to Guide Dogs for the Blind.

**NOTE:**

- Take time to allow the family to understand and consider all issues about the project. Don't rush them or yourself into making a decision.
- Be sure and have the back of the application completed (map, publicity release and your comments).

Many leaders have found it beneficial to have the raiser (and family) attend a few meetings and read the manual "How to Raise a Guide Dog Puppy" before approving the application. It gives them a good idea of what is expected, and you have the chance to better evaluate them.

If the family did not have a fence or run, but say they will build one, check back with them before the puppy arrives to be sure it is in place and secure.

**PLEASE NOTE:**

We require a new application for each puppy raised, and **STRONGLY URGE** you to do a home interview for each application, even if it is the 3rd or 17th pup for the family.

## ***Puppy Delivery***

Guide Dogs for the Blind may contact the applicant directly, or ask you, to arrange delivery of the pup. Delivery will depend on a number of factors:

- Availability of pups — it helps if you encourage the raisers not to be specific on the breed and sex of their pup.
- Date the application is received at Guide Dogs for the Blind.
- Distance away from the school. Some states are on a twice-a-year trip schedule; areas close to our facilities or with a large project enrollment are visited more frequently.
- The family's ability to drive a distance for pick-up or delivery.

In general we will be able to assign a pup within three months after receiving the application.

Puppies are from 8 to 14 weeks old when delivered. They will have been innoculated at least twice, and treated for worms twice.



Each puppy is delivered with a leather collar, a web leash, a small supply of puppy chow, heartworm preventative, pills to help prevent/cure diarrhea, and an envelope containing all pertinent information on the pup. On the collar is a plate bearing Guide Dogs' name and phone number, and the pup's identification number. This last number is also tattooed in each pup's ears, and written on its Project Record. When the pup begins to outgrow this collar an extender is available from Guide Dogs for the Blind. We suggest that the leader keep a few on hand for ready access.



## ***Veterinary Care***

In the envelope that comes with each pup is the Project Record and a number of Veterinary Statements, each bearing the pup's name and identification number. On the project record is noted when and with what the pup was inoculated, and when the next vaccinations are due.

It is important that you, the leader, ascertain that each pup is getting its required heartworm preventative daily, and the inoculations on, or as close to, the dates noted on the project record.

Be sure to explain how to use the veterinary forms and ask that they complete as much of the form as possible prior to visiting the veterinarian. Also mention that it is important to send 2 copies to Guide Dogs and keep one with the puppy's records. It may be a good idea to check record books (and shot records) at your meetings or have a Junior Leader help you with it, if you have one to help you.

Be sure that you review with each member what veterinary expenses Guide Dogs will pay for, which are: inoculations and boarding females in season. Other veterinary expenses should be authorized by Guide Dogs before treatment. This way you will hopefully avoid any confusing situations. Guide Dogs has several information sheets concerning tips for vet care that can be handled by the family. These include controlling fleas and ticks, skin care, etc.

Recommend that members develop a good relationship with their local vet and encourage the local veterinarian to utilize the expertise available from the staff veterinarian at Guide Dogs.

Guide Dogs for the Blind provides the heartworm preventative at no cost, and we suggest that the leader keep a small supply on hand for raisers who start to run out of pills.

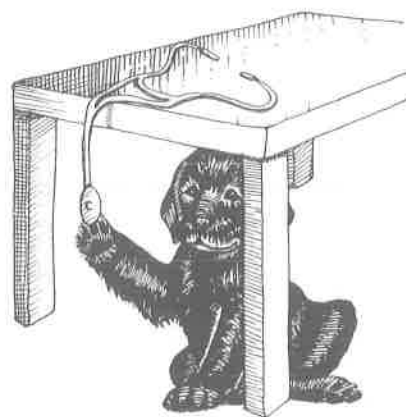

We **INSIST** on female pups being kenneled while 'in season', either at a boarding kennel or a veterinarian with adequate facilities. It helps us, and your raisers, if you contact a good kennel and make arrangements for decent care and billing prior to the need for its services.

Additional information on veterinary care is supplied in the puppy-raisers manual. Please become thoroughly familiar with it.

## ***Progress Reports and Home Visits***

Guide Dogs for the Blind has liaison personnel who will visit all counties in California and those in other states with large numbers of Guide Dog pups. This service will grow as the need develops. If you live in one of these areas our representative will contact you to arrange meetings on a yearly basis.

Whether we visit your area or not, it is **HIGHLY** recommended that you, the leader, do occasional check-ups on each pup in your group. These should be more frequent and in person for each new pup or a first-time raiser. As pups mature, and raisers gain experience, contact can be made by phone. Outcome of your visits — both positive and negative — should be reported to Guide Dogs for the Blind.



For areas where we cannot visit in person we will send the leader a progress report for each puppy in 90 day intervals. It is to be completed by you, the leader, and returned to the school as soon as possible. This will help us spot potential challenges, verify inoculations, and be able to assist in maintaining satisfactory progress.

### ***Handling Challenges and Questions***

We do not expect you to be a veterinarian or an expert dog trainer, nor do we expect you to have all the answers. We do like you to be aware of what goes on in your project.

Therefore, should a raiser encounter a challenge with the pup (be it physical or behavioral), or has a question, you should be the person contacted first. You then have the option to handle it, call Guide Dogs for the Blind, or ask the raiser to contact us.

Please do keep us abreast of any condition that may impede a pup's chances of becoming a Guide Dog. We are here to back up your efforts and decisions, and are better able to do so when we have all the information.

Local expertise often is available to you. Many veterinarians, if approached correctly, are willing to provide services or advice free of charge or at a very nominal fee. Dog training clubs or dog trainers are usually eager to help. Please be discriminate in seeking local advice/help, and, when you find a good one, please DO NOT abuse this service.

Sometimes a situation develops that warrants returning the pup to Guide Dogs for the Blind for evaluation. A serious physical flaw or a long-term treatment may be better handled by our veterinary department.

Please call during normal working hours, from 9:00 AM to 5:00 PM, Monday through Friday, at (415) 499-4000 and ask for the Puppy Placement Department or Veterinary Clinic.

The same applies to a serious temperament flaw or training problem. This could include, but is not limited to:

- Fear of loud noises, different objects or persons, unfamiliar footing or surroundings, without adequate recovery.
- Overt aggression, such as growling or snapping, to other dogs, animals or people.
- Uncontrollable behavior.
- Destructive habits (chewing, digging).



Returning a pup to the school for evaluation does not mean rejection from the program of either the pup or the raiser. We may find a reason and/or cure for the malady and return the pup to the family with appropriate suggestions. We may need to place the pup in a different (perhaps more experienced) home, and assign the original raiser a new puppy.

There MAY be a need to drop the pup from the program due to the severity of the problem. Occasionally, we have to make the decision to euthanize the pup. However, we do not take any action without first discussing it with you and/or the raiser. Most often it is offered back to the family as a pet.



As the leader, you may need a great deal of tact and compassion in helping the raiser through this process. Feelings of guilt or being a loser can be overcome with your diligent assurance. Your attitude can and does make the difference.

Every once in a while, a very difficult situation develops that necessitates removing a pup from the raiser's care without his, her, or the family's consent. As the leader, you have the prerogative to "pull a pup."

***Some reasons necessitating this action may be:***

- Abusive treatment by the raiser or family (hitting, kicking, etc.)
- Habitual neglect or lack of proper care.
- A serious breach in responsibility to this project (not socializing or training the pup, etc.)
- Disregard for your leadership, or refusal to adhere to project policy (remember your checklist?)

Should you detect such a situation developing, please discuss this with your Extension Agent and Guide Dogs for the Blind immediately. A family may not be aware of the seriousness of their attitude, may need a stern reminder from some other 'authority', and further close surveillance. We need to do whatever possible to help the raiser rectify the situation.

If, after a repeated warning, there is no improvement, the decision to remove the pup from that home may need to be made. After thorough discussion with the Extension Agent and Guide Dogs for the Blind you certainly may make that decision. It generally is better if WE make it and notify the raiser. Each case is special and should be dealt with on an individual basis.

Once arrangements have been made to remove the pup from the raiser, it generally is much better to have us evaluate the pup — if necessary — and place it in a home outside your county. This prevents the situation from being aggravated.

Please keep accurate records of all meetings, discussions or visits with the raiser regarding a challenging situation.

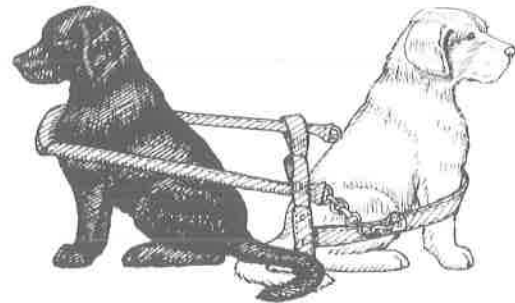

***Pup's Return For Training***

The age of returning pups will vary depending on

- Number of pups in our overall program and needs of our Training Department at the time.
- Your geographic location.

Generally, adult dogs are recalled at 14 to 18 months of age.

Approximately two weeks before adult dogs are recalled the family will receive a letter from Guide Dogs for the Blind specifying when and where to take the dog for pick-up. Often this will coincide with a local Fun Day, State Meet or other 4-H activity, and most often involves a puppy delivery.





## YOUR RESPONSIBILITIES TO YOUR CLUB

### **Meetings**

4-H Guide Dog project meetings are interesting and fun! You have ample flexibility related to where and how to hold meetings. You should have at least one per month, and two a month is great. They should be regularly scheduled (i.e. 1st and 3rd Monday at 4:30 PM) and it is a good idea to make up a six month or one year calendar. If necessary, changes can be made but if the raisers have set times the families can work it into their schedules.

You should use the older members as Jr. or Teen leaders and have them plan meetings with you. They need to do this for their record books. It is a good experience even if they are not going to hand in record books. They often have great ideas!

Be prepared for bad weather. Have things planned for indoor meetings. Some suggestions:

- Keep business meetings short. Kids and dogs don't like to sit very long.
- Vary the meetings. Don't do the same things every time.
- Community service activities can be planned at a meeting or done instead of a meeting.
- Include other 4-H events such as demonstrations, judging, public speaking.
- View a video tape (Guide Dog graduation is a great one!)
- Share recent socialization experiences. Encourage report of pup's reactions.
- Compose questions based on the information in the Guide Dog puppy manual. Each member selects one question in a random drawing and answers it.
- Share one specific characteristic of puppy (e.g. likes/hates water, sleeps heavily, always alert, eats fast/picky eater, timid around/great with little kids). This shows

whether the raiser is observant of pup's behavior, and makes them think about it.

- Let members who have returned their dogs to Guide Dogs for training, and are waiting for a new one, be partners with new raisers, or be puppy-sitters. This will relieve you of some stress, and will assist you in not having to repeat basic information that the others have already heard.
- Help members plan and organize fundraising events (e.g. flea dips, car washes, dog-related products) to earn money for the project (for veterinary expenses, socialization trips, graduations, etc.)

### **Socialization**

In addition to meetings, or in place of some (every other one?), group socialization experiences should be planned. This allows you to see the pups out of their home environment, around other animals and people, and in different situations. These should be FUN and educational experiences.

Again, have the raiser participate in the planning and making arrangements.

#### **Some ideas are:**

- Meet in a park or playground.



- Go through a shopping center, store or restaurant.
- Ride a bus, train or ferry boat.
- Go downtown for walks on a busy street.
- Take a walk in the rain or evening (sounds and shadows are different).
- Visit a veterinary clinic — *without* pups.
- Visit a nursing home.
- Visit a fire station.
- Be creative.

Plan and organize periodic exchanges of pups between raisers. This could be for a short period (weekend?) the first time, longer as the pup matures. It is a valuable experience for the pup and can be very enlightening for the raiser. Have the raiser report on differences — positive as well as negative — between their own dog and 'guest' puppy. This can also bring to attention a potential problem which may not be obvious in the pup's 'safe' home environment.

Anytime you go out into the public you, the leader, need to make sure that all the necessary arrangements have been made (let others make them), and that owners, managers or operators are expecting a group of people and *dogs!*

#### ***A few other considerations:***

- Make sure pups are clean and well groomed before going out in public.
- Keep pups on lead and under control at all times (outings in public is not puppy play time).
- When a pup is out in public, people are going to stop you and ask questions. Prepare your raisers to talk to people and stress the need to always be courteous.
- Make sure all the pups are housebroken, that they are mature enough for the experience, and that their 'shots' are up-to-date.
- Do not assume that each member knows exactly what you mean by "clean up after

your puppy"! Show them what you carry as a clean-up kit, and how to dispose of the debris.

- *Always, always* say "Thank You!" for the privilege of being there, and have one of the raisers follow it up with a 'thank you' letter.
- **WHEN OUT IN PUBLIC, THE FAMILY IS LEGALLY LIABLE FOR ANY DAMAGE THE PUPPY MIGHT CAUSE.**

#### ***Some places or areas you should avoid:***

- Escalators or moving sidewalks.
- The zoo or animal parks (it upsets the resident animals).

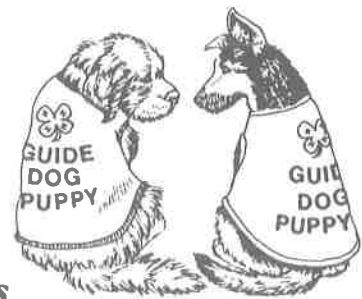

#### ***Puppy Jackets***

For easy identification and great publicity, many clubs have made up or purchased green and white puppy blankets or jackets stating "4-H Guide Dog Puppy", "Guide Dog Puppy in Training", or something similar. It is *strongly recommended* that each pup wears such a 'coat' whenever it is out in public for socialization.

Patterns may be traced from other jackets or made up specifically for your club. This could be a project for the member who is waiting for the pup's arrival. Jackets may often be purchased from other clubs at Guide Dog Fun Days or through newsletters such as Guide Dogs' own "PUPPY TALES".

Some leaders make the jacket available to each member through a club fund or a refundable sale, and *require* the pup to wear it when out in public.

Many raisers have sewn a pocket on the underside of the coat so clean-up kits and the pup's Identification card can always be carried when out socializing.



## ***Sponsorship***

Because of the expense involved, some raisers may need assistance in some form of sponsorship. This can be in the form of discounted or free veterinary care, county dog licenses, dog food or supplies (like crates or kennels). Assist your puppy raisers in getting sponsors, if needed.

Publicity and programs involving raisers and pups, explaining what you are doing for the blind and how much these dogs are needed, will help. Social and service clubs, granges, and feed stores can be good sources. Get a list of organizations from your Extension Agent and/or Better Business Bureau, and contact them offering a program for their meeting. Some educational and entertaining films and videos are available on loan from Guide Dogs for this purpose.

If you have more than one raiser needing a sponsor be sure that donations go into the club bank account, and that funds are paid only for the purpose it was intended. It is almost imperative that you involve club officers in decision making on these funds and that *you keep detailed records.*



Seek advice and help from your Extension Agent and tax accountant as well. Procedure for funds may need to be cleared with the County 4-H Program.

## ***Adult Raisers***

Applications from adults (non 4-H) should be handled in the same manner as the 4-H member's. The home interview and approval procedure should be the same. Adult applicants need to understand that for the benefit of the pup and smooth running of the program, they are expected to conform to procedures and principles just as the young raisers.

One significant difference is that Guide Dogs will give priority to the 4-H member over an adult in assigning pups.

Should you have a number of adult raisers in your club a slight change may be called for in the time of your meetings and outings. Due to work schedules, you may wish to have some early evening and/or weekend activities. Make this a club decision so that everyone benefits.

Adult raisers can be a good asset. They often can physically assist a young member with a rambunctious pup, they may be good candidates for assistant leaders, they may be extra drivers for trips, they may be able to finish raising an older pup that a 4-H'er had to give up.

## ***Publicity and Community Relations***

The relationship between your club and the community as a whole is very important because of the frequent interaction between raisers and the community. A good relationship can begin by club members offering to do a program for the many varied clubs in their communities. Elks, Rotary, Kiwanis, Soroptomist, Lions, other service, civic or social clubs, church groups, etc. are always eager to schedule programs. By educating the public in this manner, many doors to businesses and facilities in your community may be opened in a fairly easy way.

Another source for public relations and education is by giving a talk to schools and youth organizations, doing a demonstration at a pet affair or shopping center.

In addition to the publicity, this is another good way to socialize puppies and provide public speaking skill development for the 4-H members.



When you attempt to get publicity from radio or TV media, ascertain the name of the person responsible for News or Feature Stories. Make an appointment FIRST to learn the expectations concerning format, deadlines and preference for receiving information. You will then be better equipped to help your raisers do a successful job.

Good sources of publicity are Special Interest Magazines and Newspapers. If you live in a fairly large city it may be very difficult to get your message printed in the main newspaper. Smaller publications often are eager to provide easier access to publishing, especially with positive stories.

These sources may also lead to discounts and sponsorship, since the readers may take a special interest in the program.

The Development Department at Guide Dogs will provide information packets that can help you deal successfully with media people and coverage.

***Some points to tell your members about interacting with the community;***

- ALWAYS remember to *THANK* the media for ANY publicity it gives your club. Even if the names are misspelled, some facts slightly misrepresented or erroneous, write a 'thank you' letter! Strive to establish a good relationship with the media. A negative letter does not help with this effort, a positive letter *may get published!*
- Don't take turn-downs personally. When asking permission to enter a place of business, be sure to speak with the person in charge, not a clerk or employee. If the request is denied, prepare your raisers to accept the decision

without taking it as a personal offense. The owner/manager may not understand the program, may have some other valid reason or company policy to adhere to. Teach your members to smile, say 'thank you', and ask if they may explain the program or leave some literature. Many businesses have become supportive in other ways because a raiser handled a turn-down gracefully.

- *Show your appreciation in other ways.* Invite supporters to Fun Day, other 4-H or Guide Dog event (e.g. Graduation). They may appreciate seeing more of the overall program.
- *Offer your services.* How about members working as runners or 'pooper scoopers' at a dog show, ushers at a shopping mall event, etc.?
- *Always remember that you represent both 4-H and Guide Dogs.* The puppy's and the raiser's appearance, manners and attitude when out in public are extremely important. You are not just an individual, you are *the* example for a whole group of very unique people and two outstanding organizations. As a leader you may need to teach and discuss with members how to tactfully handle difficult situations.

The Puppy Placement and Development Departments at Guide Dogs will provide information and assistance. The Development Department has packets available that can help you deal successfully with media people and coverage. Please contact us by phone or writing.



***A reminder again:*** Please make sure that raisers ALWAYS CARRY, AND USE, A CLEAN-UP KIT, and their proper identification when they are out in public.

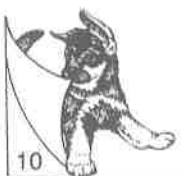



## ***State Laws Pertaining to Guide Dog Pups***

Most states now have laws or statutes regulating *Service Dogs*. Some of these provide certain "Rights" to Guide Dog raisers and their pups. You should attempt to obtain a copy of the one applicable to your state, and become familiar with it. The public library, a local agency or club for the Blind, your State Representative or Senator should be able to provide you with this.

As of this date (April 1991) the laws are:

- ARIZ. House Bill 2136, Article 24-4111, Paragraph B
- CALIF. Senate Bill No. 90
- COLO. House Bill 1207, Section 24-34-801
- IDAHO Idaho Code, Title 56, Chapter 7, Sections 56-701 through 56-707
- NEV. Assembly Bill No. 377
- ORE. House Bill 1832
- UTAH House Bill No. 150

Most of these laws focus on the rights of the individual, and, as related to this project, the "Guide Dog Trainer". Currently, most leaders are interpreting puppy raisers as "trainers", since they are training their pup in obedience and social skills. Should you choose to do so, BE FOREWARNED, this is a 4-H interpretation, not a legal one. It has not been tested in a court of law.

Even with a law stating the right of equal access to facilities, raisers must be aware of the public relations image if the law is not properly used. The law should be used *to support* a request to bring the puppy into a facility. For example, the law should be used to reassure an employee or manager who would like to help, but is nervous about legal consequences.

The law should *NOT* be used to force a reluctant individual into allowing access. With those who are reluctant to allow access, members should graciously say 'thank you' and follow instructions given in other sections of this manual.

Leaders should work with raisers so that this law is not abused.



## ***Record Books***

In the envelope provided by the School with each puppy is a 'Project Record'. This should be used by the raiser to record information on veterinary visits, kennel experiences, and various other characteristics of their pup.

Most of the time, raisers will primarily be recording the height and weight of their pup. This should be done every 4 weeks, as instructed in the record. You may wish to incorporate this as a part of some of your meetings.

The bulk of the 'Project Record' can be completed as needed, but *MUST* be completed before the dog returns to Guide Dogs. A suggestion is to have the raiser use a monthly calendar with space to write, and jot experiences down on a daily basis. Examples of items to record are: when, where and how the pup rode in a car, when the pup went into town, participated in a parade, or had a reaction to something. This information can then be transferred later into the 'Project Record'. It will be more accurate since the raiser will not have to remember such details over a long period of time.

The characteristics to be reported in the record should be a general description of the dog's behavior. One-time occurrences, or a challenge that happened for a short period, need not necessarily be emphasized. Additional comments about a trait or incident are very much encouraged, and space is provided in the back



of the record. This space may also be used for additional comments by the raiser's mom or dad.

It is important that *both* positive and negative aspects are noted, and that the record is filled as completely and accurately as possible. The information is scrutinized by our Training Supervisors, and may influence the training process the dog is about to undergo.

As the leader, you are encouraged to add your comments about the dog. However, PLEASE do *not* change any of the information, even if you feel it may not be correct.

The 4-H Organization also has records to be maintained by 4-H members. These may be obtained from your Extension office and you should familiarize yourself with them. Some of your 4-H members are very interested in attaining higher levels within the 4-H ranking, may wish to compete on a county, state and national level, and this is done through their record keeping system. If you are not comfortable working with all these records, *help is available*. Through your Extension Agent another 4-H leader can be contacted to help your 4-H members with their records.





## GUIDE DOGS FOR THE BLIND'S RESPONSIBILITY TO YOU

The School has often made the statement that without the 4-H Puppy Raisers we would not be able to provide our service at the high level that we do. Since this is true, it is equally important to relay to you that without good Project Leaders we would not have a successful puppy raising program. As a Project Leader **you** are the integral link that makes our puppy program work.

Our experience tells us that a majority of leaders in this project take on the responsibility with little or no dog *expertise*, and many also have little 4-H experience. However, with a good dose of enthusiasm, a willingness to learn, and an inclination to be a team player, the other skills can be learned or delegated. Your most important functions as a Project Leader are (1) to guide, teach, and counsel raisers, (2) to serve as an EXAMPLE to them, and (3) help them train and socialize their pups.

### ***Leader Training Seminars***

Guide Dogs now conducts Leader Training Seminars at least once a year in many areas with a sizeable project participation. This service will be expanded as the need develops. Topics covered in these sessions include: project policies and leader responsibilities, veterinary concerns, socialization and training techniques, publicity and public relations, fundraising, and any topic applicable to the region or interest of the leaders. This training is provided free of charge, and we highly recommend that leaders, new as well as experienced, attend each session.

As mentioned in an earlier section, a very important function you perform for Guide Dogs is the approval of applicants to raise a pup for us. There will be times that you may not want to approve a particular application, or have some serious doubts about it. It often is the case that the individual applying, or the family involved, is known to you through other 4-H projects, youth programs, church, school or sport activities. A 'turn-down' in this case may be difficult for you. *Please realize that the FINAL DECISION FOR PLACEMENT of our pups rests with Guide Dogs for the Blind.* We



ask that you provide us with as much supportive and corroborated information possible (please obtain names or titles). Such information may be gained from: other 4-H leaders, Humane Society or SPCA officers, teachers, neighbors, etc. After a thorough discussion with you, we may ask for some special consideration with this applicant, or WE can turn him/her down.

Guide Dogs provides much printed material free of charge to aid in the exercise of your duty. In addition, you may borrow from a small library of movies and videos. These are excellent for publicity, recruiting raisers, and general information about our program. We are in the process of producing videos covering different aspects of the Puppy Raising Project, e.g. proper exposure to different surfaces, noises, objects, etc. As they become available we will notify you.



Another service to you that is in the process of expansion is our 4-H Field Service. For quite a few years now, one of our staff-members has traveled throughout California visiting the different counties on a once-a-year rotation. We are expanding this program to the same level in other participating states.

While in your area, our representative will spend the necessary time with you to discuss individual pups and/or raisers, observe a pup or the whole group in a particular setting or on an outing, evaluate pups for general temperament, visit raisers in their home, visit the Extension Agent or office (where possible), and cover as many aspects of the project as possible.

The benefits of this program are two-fold. It provides you, the leader, and the raisers direct access to Guide Dogs. Many issues can be made more clear in person, and we are able to

reinforce your position as the leader for the project. At the same time, we learn more about our pups, our program, and your needs at the local level.

Occasionally, a matter will come up that requires your decision almost on-the-spot. An example may be: an *emergency* visit to the veterinarian, an unfortunate encounter with an irate storeowner, an undesirable display of behavior (by the raiser *or* the pup), etc. When this happens, we urge you to contact us as soon as feasible with details of the incident and your decision. If a dispute arises, we will do what we can to bolster your position as the leader. However, we can only do so when we have *all* the facts, with as much supportive evidence as possible. Guide Dogs for the Blind has always had the policy to "back" out leaders where appropriate.





## YOUTH DEVELOPMENT THROUGH GUIDE DOG PUPPIES

### ***Leadership Through Group Experience***

Leadership is the ability of being able to influence the thinking and actions of people. It is the willingness to try a new job and see it through. The group or club environment is very important in developing leadership skills in young people. Work with their peers as well as with the adults in the group needs to be fostered. Leadership experiences, whether they are formal — such as club officers, committee chairs, program chairs, or informal — such as assuming responsibility for a necessary task, provide skill development.

Your role as a leader is one of encouragement, support, and coaching in the “how to” of these essential skills. Coaching means *helping* a person toward greater self-understanding or self-determination. To “coach” or counsel a person is to help him/her accept responsibility for his/her own decisions, and to develop the ability to handle problems with increased independence.

When you, the adult leader, become a coach, you slip into a role where you:

- ask questions to stimulate thinking
- offer ideas to help explore alternatives
- demonstrate a skill to show a *possible* solution
- serve as a ‘sounding board’

You do not *tell*, you *teach*. You do not *do it* for the member, you *support* the member in his/her endeavor.

Often, this can be one of the more difficult aspects of being a 4-H Leader. It can be very frustrating to watch youngsters “do it *their* way”, but it is often the best way a person learns what works and what does not.

### ***Self Esteem Through Accomplishment and Recognition***

The concept of positive leadership is further enhanced by the development of “self-esteem”.



This is when a person likes and feels good about him- or herself. It is cultivated when one knows a task has been done well and it is recognized by others. This recognition can be as subtle as a pat on the back by you, or as obvious as a group announcement or award in front of the club. As a child grows older, recognition by and with his or her peers becomes very important.

Leaders have the tremendous responsibility of assuring that *each* youngster has self-esteem building experiences. As a leader you should try to find something positive about each member and communicate it to them each time you meet with them.

Be sure to emphasize that a youngster is successful in the Guide Dog Puppy Project if he/she takes on the responsibility, does it well, and fulfills the obligations. The obligations include taking responsibilities in the club as well as proper care and raising of the pup.



Graduation of the dog as a Guide is not necessarily related to the successful completion of this project. *All* members should be fully aware of this. No person should be made to feel that they did not do a good job in raising their puppy simply because it did not graduate from the Guide Dog program.



### ***Decision Making Through 4-H Judging***

It is important to participate in 4-H judging experiences either on a club or county level. Judging contests are a fun way to practice 'decision making' skills. This gives the members the opportunity to make choices among identified alternatives and back up their decisions with reasons based on factual knowledge or skill.

By participating in 4-H judging contests, a young person can practice making decisions and suffer little or no personal consequence if a poor choice is made. Later in life, when the decisions get harder and the consequences more severe, 4-H judging experiences may help them make better choices and have a more clear understanding of the decision-making process.

#### ***Examples of decision-making experiences are:***

- proper training techniques
- proper toys or equipment
- rank quality for a defined purpose (e.g. best dog food or flea spray)
- best photo display, etc.

The 4-H Organization has a multitude of material for use in and to explain 4-H judging. Contact your Extension office.



### ***Responsibility Through Guide Dog Puppies***

If there is just one thing this 4-H project can teach a youngster it is RESPONSIBILITY.

Each day the puppy raiser must feed the pup, take it for a walk, give it a pill, clean up after it, and teach it how to be an acceptable member of the family. Many people compare this experience to raising a child. Unlike many other 4-H projects the member cannot work with the animal for an hour a day or when he/she feels like it, and then leave it in its pen the rest of the time. This puppy is with the member or the family most of the day, *EVERYDAY*.

The puppy raiser is responsible for the pup's well-being all of the time. Therefore, the member inevitably becomes more dependable, reliable and consistent.

4-H AND GUIDE DOGS FOR THE BLIND, INC. ARE WORKING TOGETHER TO DEVELOP WELL ROUNDED PUPPIES AND WELL ROUNDED YOUTH.

BY FOLLOWING THE GUIDELINES IN THE MEMBER'S MANUAL YOU WILL HELP TO DEVELOP THE PUPPIES. BY INCORPORATING THE ABOVE GUIDELINES INTO EACH OF YOUR MEETINGS YOU WILL BE DEVELOPING YOUTH, THEREBY DOING A GREAT SERVICE TO GUIDE DOGS FOR THE BLIND, THE CLUB YOU LEAD AND YOUR COMMUNITY AT LARGE.



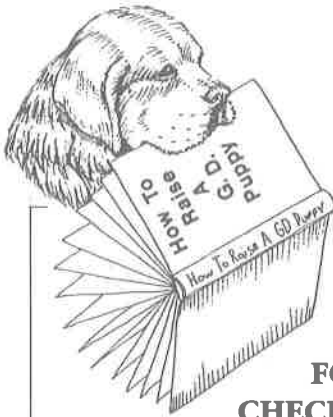

**FOLLOWING ARE EXAMPLES OF HOME VISIT  
CHECKLISTS AND AGREEMENTS. THESE MAY BE USED  
VERBATIM OR ALTERED TO FIT YOUR SPECIFIC NEEDS.**









**FACT SHEET/CHECK LIST ABOUT THE PUPPY RAISING PROGRAM**

Name of Puppy Raiser \_\_\_\_\_

- \_\_\_\_\_ Raise your puppy as an inside dog. It must sleep next to the bed of the 4-H raiser.
- \_\_\_\_\_ There must be a safe, fenced-in yard or dog run for the puppy when it is to be left outside.
- \_\_\_\_\_ You must pay for all your puppy's food, vitamins, and supplies.
- \_\_\_\_\_ At four months your pup will be given his rabies shot by Dr. Dietrich.
- \_\_\_\_\_ When possible, notify your leader before going to the vet, and always give your leader a report after your puppy has been seen by a vet, and write it in your project record.
- \_\_\_\_\_ The Attending Veterinarian Statement **MUST BE COMPLETED BY** your vet and returned to Guide Dogs **EVERY TIME** your puppy is seen by a vet other than Guide Dogs.
- \_\_\_\_\_ You are to check with your county/city into obtaining a dog license for your puppy. All puppies must be licensed.
- \_\_\_\_\_ All travel expenses are the obligation of the family. This includes field days and going to your dog's graduation.
- \_\_\_\_\_ All expenses incurred in raising the Guide Dog Puppy (food, vet bills, travel and damages) are tax deductible. Seek advice as to documentation of bills from a competent tax person.
- \_\_\_\_\_ Approximately 50% of all dogs returned to Guide Dogs "make it" as Guides. If your puppy is a "career change" puppy you will be notified and asked if you would like to have him as a pet. If your puppy will graduate (about six months after it has been recalled) you will be invited, at your expense, to attend the graduation and present the dog either to the school as a "breeder" or to a blind student during the graduation ceremony.
- \_\_\_\_\_ It is the parents' obligation to see that the 4-H'er attends his/her club meetings and the project meetings.
- \_\_\_\_\_ If you have problems with your puppy contact the project leader. Don't wait until a minor problem becomes a major one.
- \_\_\_\_\_ The puppy must be seen *once a month* by the leader and surprise visits may be made by your leader.
- \_\_\_\_\_ If it is determined that the dog's needs, either socialization or health, are not being met, the leader or anyone from Guide Dogs for the Blind, Inc. is authorized to remove the dog from your home.
- \_\_\_\_\_ While in the puppy raiser's home, the raiser is expected to housebreak the pup, attend regular project meetings with the puppy and socialize it to people, animals, traffic, strange surroundings, situations and noises.
- \_\_\_\_\_ Basic obedience training is encouraged to aid in the pup's socialization program and for general control purposes. However, we do not attempt to make show dogs out of our puppies, for the obedience would be much too strict for our purposes.
- \_\_\_\_\_ To become an effective Guide Dog, a pup **MUST** have the advantage of a family atmosphere and association with the outside world. The puppy must not be left alone for long periods of time unsupervised. Love and socializing is the most important part of raising a Guide Dog puppy.

- \_\_\_\_\_ You are to read the manual entitled "How to Raise a Guide Dog Puppy".
- \_\_\_\_\_ Adult puppy raisers will be expected to follow the same rules that have been set for the 4-H puppy raiser.
- \_\_\_\_\_ Raising a puppy takes total family commitment. Your puppy will be a family member and everyone must assume their share of the responsibility.
- \_\_\_\_\_ Flea control is a health problem: it is paramount that puppies are kept flea free to prevent allergies from developing.
- \_\_\_\_\_ Puppy blankets will be given when puppy arrives.
- \_\_\_\_\_ Blanket must be returned at the end of the project regardless of its condition.
- \_\_\_\_\_ There will be a \$20.00 charge if blanket is lost.
- \_\_\_\_\_ Blankets and puppy *must* be clean and neat when appearing in public.
- \_\_\_\_\_ Both the pup and the 4-H raiser must be on their best behavior when out in public because they represent a) their families, b) 4-H, and c) Guide Dogs for the Blind.
- \_\_\_\_\_ *Do not* take the puppy into public places until you are sure it is housebroken.
- \_\_\_\_\_ Remember, you represent *all* 4-H Guide Dog raisers who have worked very hard to get permission to go into business establishments. If you or your puppy misbehaves, *all* raisers may be banned from the establishment you offend.
- \_\_\_\_\_ If your behavior is consistently poor the puppy *will* be removed from your home.
- \_\_\_\_\_ When riding in a car, the puppy must be secured so it will not interfere with the driver and cannot get on the seat or put its' head or nose out the window.
- \_\_\_\_\_ You must have a leash on the puppy while it is in a car for easy handling.
- \_\_\_\_\_ Puppy should *never* be left tied to a tree or other anchoring. Do you know why?
- \_\_\_\_\_ The pup should ride on the floor of the car if a trip lasts one hour or less. If you take a long trip the pup may ride in the back of the car.
- \_\_\_\_\_ If your pup is ever seen riding in the back of an open truck, your pup will be removed from your home, period.
- \_\_\_\_\_ Report any drooling or vomiting episodes during car or other vehicle rides to your leader immediately.
- \_\_\_\_\_ *Every* time your dog defecates you *must* clean it up; at home, in your yard, or out in public. Do you know why?
- \_\_\_\_\_ Puppy handler must have a clean-up kit with him at all times on outings.

Signature of parents \_\_\_\_\_

Puppy Raiser \_\_\_\_\_

Leader \_\_\_\_\_



## 4-H GUIDE DOG PUPPY RAISING PROJECT INFORMATION SHEET AND CHECK LIST

Name of Puppy Raiser \_\_\_\_\_ Date \_\_\_\_\_

- \_\_\_\_\_ The puppy is to be raised as an inside dog. He/She is to be allowed to sleep in the bedroom of the 4-H raiser.
- \_\_\_\_\_ There must be a safe, fenced-in yard or dog run for the puppy when he/she is to be left outside.
- \_\_\_\_\_ **Love** and **Socializing** is the most important part of raising a Guide Dog and taking him out into the public is of great importance.
- \_\_\_\_\_ A few dogs will be selected from the puppies raised to be breeders. We do not know which you will receive, a Breeder or a Guide, or a Change-of-Career dog.
- \_\_\_\_\_ The puppy must be seen once a month by the leader and surprise visits may be made by your leader.
- \_\_\_\_\_ The puppy is to be taken to the vets when the family or leader feels an examination is necessary. You must pay for all your puppies Vet bills with the exception of the shots and fecal exams. Worming must be paid for by you. No bill will be paid for by Guide Dogs for the Blind unless they have approved it prior to you incurring the debt.
- \_\_\_\_\_ When possible notify your leader before going the vets, and always give your leader a report after your puppy has been seen by a vet.
- \_\_\_\_\_ You must pay for all your puppy's food and vitamins and supplies.
- \_\_\_\_\_ All travel expenses are the obligation of the family. This includes Field Day at San Rafael in August, and field days throughout the year, and going to your dog's graduation.
- \_\_\_\_\_ All expenses incurred in raising the Guide Dog; food, vet bills, travel and damages are tax deductible. Seek advice as to documentation of bills from a competent tax person.
- \_\_\_\_\_ It is the parents' obligation to see that the 4-H'er attends his/her 4-H Club meetings and the Project meetings (usually two a month).
- \_\_\_\_\_ Approximately 50% of all dogs returned to San Rafael "make it" as Guides. If your puppy is rejected you have first refusal rights to that puppy. If your puppy "makes it" (about six months after it has been recalled) you will be invited, at your own expense, to attend graduation and you will be asked to present the dog to the school either as a "breeder" or to a blind student during the graduation ceremony.
- \_\_\_\_\_ If you have problems with your puppy contact your puppy leader. Don't wait until a minor problem becomes a major one.
- \_\_\_\_\_ If it is determined that the dog's needs, either socialization or health, are not being met, the project leader or anyone from Guide Dogs for the Blind is authorized to remove the dog from your home.
- \_\_\_\_\_ Flea control is the number one health problem we have in the Sacramento area. It is paramount that puppies are kept flea free to prevent flea allergies from developing.



\_\_\_\_\_ Your family will read the manual entitled "How to Raise A Guide Dog Puppy" by \_\_\_\_\_(date), and the raiser will be able to answer a short quiz based on that manual.

\_\_\_\_\_ At least 3 meetings must be attended before a home check will be done and an application sent to San Rafael for a puppy. There is no choice for your first puppy. There is about a \_\_\_\_\_ wait for your puppy.

\_\_\_\_\_ The 4-H'er must attend at least 50% of the project meetings or a new application will NOT be accepted.

\_\_\_\_\_ The 4-H'er must attend at least 1 (one) Field Day or a new application will NOT be accepted.

\_\_\_\_\_ If 6 (six) consecutive meetings are NOT attended the puppy placement will be re-evaluated and the puppy being raised will possibly be pulled from your home and re-assigned.

Signature of 4-H Raiser \_\_\_\_\_ Date \_\_\_\_\_

Signature of 4-H Leader \_\_\_\_\_ Date \_\_\_\_\_

Signature of both parents \_\_\_\_\_ Date \_\_\_\_\_

\_\_\_\_\_ Date \_\_\_\_\_

**FACT SHEET/CHECK LIST ABOUT THE PUPPY RAISING PROGRAM**

Name of Puppy Raiser \_\_\_\_\_

- \_\_\_\_\_ The puppy is to be raised as an inside dog. It is to be allowed to sleep in the bedroom of the 4-H raiser.
- \_\_\_\_\_ There must be a safe, fenced-in yard or dog run for the puppy when it is to be left outside.
- \_\_\_\_\_ The puppy will be taken to the vets when the family or leader feels an examination is necessary. You must pay for all your puppies vet bills with the exception of the shots and fecal exams. Worming must be paid for by you. No bill will be paid for by Guide Dogs for the Blind, Inc. unless they have approved it prior to you incurring the debt.
- \_\_\_\_\_ At four months your pup will be given its rabies shot by a Veterinarian.
- \_\_\_\_\_ When possible notify your leader before going to the vet's, and always give your leader a report after your puppy has been seen by a vet.
- \_\_\_\_\_ The Attending Veterinarian's Statement **MUST BE COMPLETED** by your vet and returned to Guide Dogs **EVERY TIME** your puppy is seen by a vet.
- \_\_\_\_\_ You are to check with your county/city into obtaining a dog license for your puppy. Usually all puppies must be licensed, but in some cases your county/city may waive the fee.
- \_\_\_\_\_ All travel expenses are the obligation of the family. This includes field days and going to your dog's graduation.
- \_\_\_\_\_ All expenses incurred in raising the Guide Dog puppy: food, vet bills, travel and damages are tax deductible. Seek advice as to documentation of bills from a competent tax person.
- \_\_\_\_\_ Approximately 50% of all dogs returned to San Rafael "make it" as Guides. If your puppy is rejected you will be notified and asked if you would like to have him as a pet. If your puppy "makes it" (about six months after it has been recalled) you will be invited, at your own expense, to attend graduation and present the dog to the school either as a "breeder" or to a blind student during the graduation ceremony.
- \_\_\_\_\_ It is the parents' obligation to see that the 4-H'er attends his/her club meetings and the project meetings.
- \_\_\_\_\_ If you have problems with your puppy contact your project leader. Don't wait until a minor problem becomes a major one.
- \_\_\_\_\_ The puppy must be seen once a month by the leader and surprise visits may be made by your leader.
- \_\_\_\_\_ If it is determined that the dog's needs, either socialization or health, are not being met, the project leader or anyone from Guide Dogs for the Blind, Inc. is authorized to remove the dog from your home.
- \_\_\_\_\_ While in the puppy raiser's home the raiser is expected to housebreak the pup, attend regular project meetings with the puppy and fully socialize it to people, animals, traffic, strange surroundings, situations and noises.



- \_\_\_\_\_ Basic obedience training is encouraged to aid in the pup's socialization program and for general control purposes. However, we do not attempt to make show dogs out of our puppies, for the obedience would be much too strict for our purposes.
- \_\_\_\_\_ To become an effective Guide Dog, a pup MUST have the advantage of a family atmosphere and association with the outside world. The puppy must not be left alone for long periods of time unsupervised. Love and socializing is the most important part of raising a Guide Dog puppy.
- \_\_\_\_\_ You are to read the manual entitled "How to Raise a Guide Dog Puppy".
- \_\_\_\_\_ Socialization sheets are to be completed on a monthly basis and reviewed by your leader.
- \_\_\_\_\_ Adult puppy raisers will be expected to follow the same rules that have been set forth for the 4-H puppy raiser.
- \_\_\_\_\_ Raising a puppy takes total family commitment. Your puppy will be a family member and everyone must assume their share of the responsibility.

We have read and discussed with the 4-H leader the above regulations and fully understand our obligations in raising a Guide Dog Puppy.

Signature of 4-H raiser \_\_\_\_\_

Signature of both parents \_\_\_\_\_  
or guardians \_\_\_\_\_

Signature of 4-H leader \_\_\_\_\_

Date \_\_\_\_\_



## 4-H GUIDE DOG PUPPY RAISING PROJECT RAISER/PARENT INFORMATION SHEET AND CHECK LIST

Name of Puppy Raiser \_\_\_\_\_ Date \_\_\_\_\_

### A. **BEFORE YOUR PUPPY ARRIVES:**

1. \_\_\_\_\_ Read over the Puppy Manual given to you by the project leader. Mark any area you may have any questions about. Ask at home visit when your project leader goes through the manual with you.
2. \_\_\_\_\_ Home Visit: All family members must be present at this important visit. At this interview the Guide Dog Project Leader will give information that is important for each family member. **THIS IS A FAMILY PROJECT AND THE RAISER CANNOT DO IT ALONE . . .** therefore **ALL** family members must follow the same rules and training procedures.
3. \_\_\_\_\_ Usually four consecutive monthly project meetings must be attended by the prospective raiser and a **PARENT** before a puppy will be assigned. There may a six month wait to receive your puppy.

### B. **WHEN YOU LEARN YOU HAVE BEEN ASSIGNED A PUPPY:** *(Call project leader)*

1. \_\_\_\_\_ Ask your project leader for:
  - ▶ Papers from San Diego Health Dept., N.C.T.D. and your Guide Dog I.D. Card
  - ▶ Puppy Crate (see 8)
  - ▶ Puppy Jacket (this identifies your puppy as a Guide Dog in training and must be returned to your project leader when your puppy goes back for training)
2. \_\_\_\_\_ Contact your Veterinarian and explain the project to him/her. Ask if they are willing to treat a Guide Dog Puppy and turn in the paper work we require. If your vet has any questions ask your leader to make an appointment to talk to him/her.
3. \_\_\_\_\_ Purchase food. It is recommended that you feed Purina Puppy Chow for the first month to prevent extra stress on your puppy. This is what they are fed at Guide Dogs. Any puppy food that is less expensive is **not acceptable** but better grade food may be fed.
4. \_\_\_\_\_ Buy a water dish and a food dish. Stainless steel dishes are the best as they are easier to keep clean.
5. \_\_\_\_\_ Buy chew toys and play toys. Most puppy chewing can be avoided if they have their own toys to chew on.
6. \_\_\_\_\_ Go over your yard again and make sure your pup cannot get out.
7. \_\_\_\_\_ Puppy proof house. This is especially important in the raiser's bedroom.
8. \_\_\_\_\_ A CRATE, provided by the project, will be used as a housebreaking tool and will be used only (1) to sleep the puppy in at night, (2) for short periods during the day, not to exceed \_\_\_\_\_ hours, (3) **NEVER** as a form of punishment. This crate will be picked up when it is no longer needed. (Usually 6 months).



9. \_\_\_\_\_ If your puppy will be left alone unsupervised, for more than four hours daily, your leader must know and approve of your schedule.
10. \_\_\_\_\_ Understand that **LOVE** is the most important thing you can give your puppy. He must *receive* love to be able to give it. **SOCIALIZATION** is one of the most important parts of raising a Guide Dog Puppy and taking him out in public and exposing him to the world he'll work in is a most important job. **PROTECTING** your puppy is also important — **never let your puppy off leash**, unless he is in a fenced yard.
11. \_\_\_\_\_ FLEA CONTROL is the number one health problem we have. It is paramount the puppies are kept flea-free to prevent flea allergies. To keep the puppy comfortable and flea-free, you must be prepared to spray your house and yard regularly. Professional Pest control is recommended.
12. \_\_\_\_\_ Be sure you are signed up in your area 4-H Club by your leader.
13. \_\_\_\_\_ Remember this is a very **involved** project and you are expected to be an **active** member. You must attend all meetings and activities. (If you are unable to attend you *must* be excused by leader).

**C.        WHEN YOU FIRST GET YOUR PUPPY:**

1. \_\_\_\_\_ Order an I.D. tag with pups Name, Address, Phone. Put on collar as soon as possible.
2. \_\_\_\_\_ **REVIEW** the manual on housebreaking and early training. Your cute fifteen pound puppy will, all too soon, become a 45 to 60 pound dog. You must learn to control him when he is small or you will never be able to control him when he is big.
3. \_\_\_\_\_ You will receive a booklet called the **GUIDE DOG PROJECT 4-H RECORD** the day you get your puppy. This booklet will have your puppy's name, I.D. number, and his birth (whelp) date. It will tell what shots he has already received and what and when he needs to have yet. Your leader or vet will give the D.H.L.P.P. shots and you must take your pup to a vet for his rabies shot at four months of age. At this time you must also provide your vet with a FRESH fecal specimen for worm testing. You must also weigh and measure your puppy every four weeks and write those figures in this booklet. Refer to the booklet often. When the puppy goes back for his formal training, Guide Dogs **must** have this booklet returned to them, filled out and up to date.
4. \_\_\_\_\_ Make a copy of the front of Guide Dog Project 4-H Record and give to leader. The info on the front will be recorded and checked about every 3 months to be sure it is up to date.
5. \_\_\_\_\_ Your puppy comes with his collar, it is **never** to be removed. This collar has a brass plate on it with two important bits of information. The first is the name and phone number of Guide Dogs for the Blind, the second is your puppy's I.D. number. Choke chains must **never** be used without permission from your leader. If you have done your job of training he should not need one.



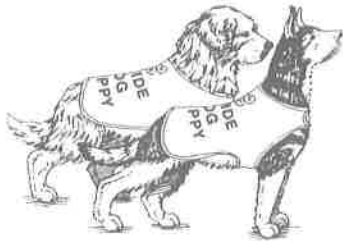

Club meetings \_\_\_\_\_ Project meetings \_\_\_\_\_ at \_\_\_\_\_

## CLUB AND PROJECT OBLIGATIONS

1. \_\_\_\_\_ It is the parent's obligation to see that the 4-H'er attend his/her 4-H Club meetings and the Project meetings and activities. Parents must attend project meetings. Your child's achievement will be directly proportionate to your involvement.
2. \_\_\_\_\_ You must make 90 percent of your Project meetings. If you cannot make a meeting *call your leader to be excused*. You may attend one of the other Guide Dog Meetings to make it up. Two or more missed meetings can result in the pup being removed from your home.
3. \_\_\_\_\_ It has taken many years to open the businesses and restaurants to Guide Dog Puppies in Training. In order to keep the good will of the business people all over the country we have several rules that **must** be followed.
  - ▶ *All feces must be picked up and disposed of properly.*
  - ▶ *Inside a building all puddles must be cleaned and disposed of.*
  - ▶ *Your pup **must** wear his coat as identification when in public.*
4. \_\_\_\_\_ Always be a good representative for Guide Dogs and the 4-H Club. You are always in the eye of the public.
5. \_\_\_\_\_ When taking your puppy out to relieve himself, be sure to remove his coat. Puppies who learn to relieve while wearing the coat may think it proper to relieve "in harness" which is never permissible.
6. \_\_\_\_\_ Approximately 50 percent of all puppies "make it" as Guides. If your pup is dropped, becomes "Career Changed" you will have first rights to that pup. If your pup "Makes it" (about 6 months after going into training) you will be invited, at your own expense, to attend and present your dog, either to the school as a "Breeder" or to a blind student during the graduation ceremony. It is requested that you wear your 4-H uniform at Graduation. Your picture will be taken with the blind person and your dog for distribution to your local newspaper.

## THE BOTTOM LINE

1. \_\_\_\_\_ If it is determined that the dog's needs, either socialization or health, are not being met, the project leader or anyone from Guide Dogs for the Blind, Inc. is authorized to *remove* the dog from your home.
2. \_\_\_\_\_ Re-read the above information. If you do not feel comfortable with any one of the above statements please do not fill out an application.
3. \_\_\_\_\_ Only those families who really want to be involved in this project and think they can see the project through to a conclusion should submit an application. Even with the best intentions sometimes circumstances will overcome a family and a pup has to be returned to the project leader to be finished out.
4. \_\_\_\_\_ If you are raising a Female *you must* put her in an approved kennel when she comes in season. Usually between 6 to 12 months of age. We have two kennels at present that are approved by our group. First choice and *strongly recommended* is **Fon-Jon Boarding Kennels, 5050 Sante Fe, San Diego, Tel. 273-2266**. Second Choice is **The Animal Keeper, Oceanside Blvd., Oceanside**. You **must** inform your leader before you call the kennel. Always bring Rabies certificate and Attending Vet Statement to kennel with pup.

5. \_\_\_\_\_ When your puppy is 4 months of age he must have his Rabies shot and be licensed. Fill out the form from the vet, marking Guide Dog and send to:

Dept. of Animal Control  
Attn: Virginia  
5480 Gains St.  
San Diego, CA 92110

Oceanside Res. send to:

Oceanside Human Society  
Attn: Mary Johner  
P.O. Box 6849  
Oceanside, CA 92054

6. \_\_\_\_\_ Heart Worms are now prevalent in our area. They **are** life threatening. If your pup gets heart worms the cure is often fatal. Therefore we are given preventative medication (received with your pup). Daily doses are:

Start at	15 pounds	with	1/4 tablet
	30 pounds		1/2 tablet
	45 pounds		3/4 tablet
	over 60 pounds		1 tablet

7. \_\_\_\_\_ When possible, notify your leader before going to the vet's and always give your leader a report after your pup has been seen by a veterinarian.

### YOUR OLDER PUPPY

1. \_\_\_\_\_ If you have a problem with your puppy, contact your project leader. **DON'T WAIT UNTIL A MINOR PROBLEM BECOMES A MAJOR ONE . . . .** Remember you are not expected to have all the answers . . . BUT . . . you are expected to act in the best interest of the dog and ask for help when it is needed. That's what the leader and club is there for.
2. \_\_\_\_\_ Your puppy must be seen at least once a month by the leader and surprise visits may be made by your leader at any time.
3. \_\_\_\_\_ Your puppy **must** be taken to the vet's when the family or the leader feels an examination is necessary. You will be expected to pay for ALL your puppy's vet bills with the exception of shots and fecal exams. If tape worms are present see your leader for medication provided by Guide Dogs. This will save you money. No bill will be paid by Guide Dogs unless they have approved it prior to you incurring the debt.
4. \_\_\_\_\_ Although the pup is valued at 500.00 when he is placed in your care if something happened to him you would not be billed for his value.



## 4-H GUIDE DOG PUPPY PROJECT CHECK LIST

Name of Puppy Raiser \_\_\_\_\_

Phone \_\_\_\_\_

\_\_\_\_\_ Raising a Guide Dog puppy takes total family commitment. Your puppy will be a family member, and everyone must treat it according to established guidelines. The booklet "How to Raise a Guide Dog Puppy" should be read and/or understood by all the family.

\_\_\_\_\_ Why do you want to raise a Guide Dog puppy? Will you be able to give up the puppy when the time comes?

\_\_\_\_\_ The puppy is to be raised as an inside dog and must be allowed to sleep indoors, preferably in the raiser's room. Where will your puppy sleep? \_\_\_\_\_

An airline kennel or crate is very useful to have to help care for and train the puppy. Might you be able to get one or borrow one for the first several months?

\_\_\_\_\_ There must be a safe and secure fenced yard, run, or kennel to use when the puppy is outside. It should have available shelter from hot sun or rain. A recommended basic size is 4'x12' or the equivalent. Puppies are never to be left on a chain or tied up. Puppies should not be allowed to run loose in an unfenced area.

\_\_\_\_\_ Will you have the time to devote to this project?

- ▶ *There will be extra attention and handling at home. Proper house behavior training, grooming, and socializing on your own will be required.*
- ▶ *Attendance at 4-H meetings 3 to 4 evenings per month, plus additional group activities on a weekend may be scheduled.*
- ▶ *It will be the parents' obligation to see that transportation to meetings and outings is provided. If the raiser cannot always attend, another family member may act as substitute.*
- ▶ *The 4-H advisor(s) needs to see the puppy regularly at meetings to observe its progress, health, problems you may be having, and to assist you with questions that arise. Your advisor may make a surprise check-up visit to your home at a later date.*
- ▶ *Socializing the puppy is extremely important. Puppies should be taken to as many different places and functions as possible when it is safe and appropriate to do so. Familiarize the pup to people, animals, traffic, strange surroundings, and noises. All family members are encouraged to participate in this process whenever possible.*

\_\_\_\_\_ You must follow the immunization and exam schedule as specified by Guide Dogs for the Blind. Routine shots, fecal exams, and boarding of females in season are paid for by Guide Dogs. Other veterinary expenses are the responsibility of the family. No vet bill will be paid by Guide Dogs for the Blind unless they have approved it in advance. The vet statement report in your puppy kit must be completed and returned to Guide Dogs each time your puppy sees the vet.

\_\_\_\_\_ Females in season must be boarded at a kennel or veterinarian — NO EXCEPTIONS. Notify your advisor when this occurs and where the pup is staying. DO NOT have your puppy spayed or neutered without instructions from Guide Dogs for the Blind!

- ▶ *Your advisor should be notified of health problems before they become Problems! It is possible that we may need advice or permission from Guide Dogs in handling certain cases. Please do take your puppy to the vet if it is an emergency and notify the advisor as soon as you can.*

- \_\_\_\_\_ Food, vitamins, equipment, supplies, and travel expenses are your responsibility. These and other related expenses may be tax deductible. Obtain specific advice from a competent tax person.
- \_\_\_\_\_ If at all possible, young puppies should not be left alone unsupervised for long periods of time. What is the family daytime schedule? \_\_\_\_\_
- \_\_\_\_\_ Basic obedience is necessary as a tool to aid in controlling the behavior of your puppy, at home and in public. You will learn how to accomplish this in the Guide Dog way at the regular 4-H meetings. We do not attempt to make our pups "show" dogs, nor do we do AKC obedience.
- \_\_\_\_\_ Puppy blankets can be provided when the puppy arrives. Blankets must be returned when your project is completed, regardless of its condition. There will be a \$20 charge if the coat is lost. Blankets are the property of the Extension Office.
- \_\_\_\_\_ You are aware that these puppies will grow into big dogs; sometimes *very* big dogs! We can request a breed of dog that has the potential to more or less match the size of the raiser; however, there is no guarantee that a specific breed or sex will be available. Will you be willing to accept whatever pup is ready for you? \_\_\_\_\_
- \_\_\_\_\_ Raising a Guide Dog puppy is an official 4-H project. It is *not* competitive in and of itself. You may compete with your record book or in showmanship, but it is not required. Please notify your advisor if you intend to enter showmanship.
- \_\_\_\_\_ If it is determined that the puppy's needs — either socialization, safety, or health — are not being met, the advisor(s) or a representative of Guide Dogs for the Blind is authorized to remove the puppy from the raisers home.
- \_\_\_\_\_ Adult puppy raisers will be expected to follow all the same rules and guidelines as the 4-H raiser.
- \_\_\_\_\_ What other pets or animals do you have? \_\_\_\_\_
- \_\_\_\_\_ If you have other pet dogs, it is expected that all of their immunizations will be current before your puppy arrives.
- \_\_\_\_\_ Approximately 50% of the dogs returned to San Rafael will pass their formal training and become working guides or breeders. If your dog cannot be used by Guide Dogs for the Blind, you will be notified and asked if you would like to have it as a pet. The cost of returning the dog to you will be your obligation.
  - ▶ *If your dog completes the training or will be used for breeding, you will be invited to San Rafael to present the dog to its blind partner or to the school during a formal graduation ceremony.*

We have read and discussed the above regulations with the County Guide Dog advisor(s) and fully understand our obligations in raising a Guide Dog puppy.

We agree that upon receiving our puppy, we will follow and abide by all guidelines set forth in "How to Raise a Guide Dog Puppy", the Polk County 4-H Raisers Manual, and will fully cooperate with the 4-H advisor(s).

Signature of Puppy Raiser _____	Date _____
Signature of both Parents or Guardians _____	Date _____
_____	Date _____
Signature of 4-H advisor(s) _____	Date _____
_____	Date _____
Signature of 4-H Extension Agent _____	Date _____



## ACKNOWLEDGEMENTS

*This manual is the result of material, suggestions, and information supplied by a vast number of leaders, Extension Agents and staffmembers. It truly is impractical to "THANK YOU!" all by name.*

*However, a few individuals made **significant** contributions, and we would like to recognize you for your efforts:*

<b>Kathy Williams</b>	4-H Extension Agent and puppy raiser
<b>Barbara Burks</b>	4-H Leader, puppy raiser and staff
<b>Jane Ellis</b>	4-H Leader and puppy raiser
<b>Chuck Jordan</b>	Staff
<b>Donna Zick</b>	4-H Leader and puppy raiser
<b>Nancy Rand</b>	4-H Leader and puppy raiser

*For the illustrations we are indebted to:*

**Ellen Leonard** of Toledo, Ohio



## SUPPLEMENT FOR L-H PUPPY RAISERS' MANUAL

### FEEDING

An exact schedule for feeding a pup is not desirable any more than it would be with a child. A pup from three to four or five months of age is in the hungry stage and will eat more at a feeding, in most cases, than it will ever eat again. It is like a Junior High School boy. Give it all it needs, in many cases this will be a lot, but he will get less hungry as he gets that frame built. If he is inclined to eat more than you know he needs, use your own judgment, but with two feedings a day he is not likely to over eat, although some do just as some of us do and these need the restraining hand.

Do I have to feed meat? We feed half a pound of horse meat daily and think that when added to good complete dog foods it serves a very desirable growth factor, that of muscle development. More meat is not needed. If table scraps, including meat drippings, left over gravies, cooked vegetables, soups, any bread or potatoes which have had butter or gravy on them, are fed they make up in a large extent for the lack of meat. In fact, Ken-L-Biskit and Gaines and some others have a good deal of meat in them. A poached egg twice a week with either of these will do very well.

### JUMPING ON PEOPLE

Dogs should not be allowed to jump on people. The best way to prevent it is to teach the pup the word "No". Whenever the pup jumps on any member of the family, the person being jumped on should take the pup's front paws in his hands and gently step on its' hind toes while commanding "No". Do this every time and in a week the habit should be broken so that only the word will be necessary to prevent any future attempts.

(note: we teach the blind students to use the word "No"; the words "Stay" and "Down" are used in the obedience exercise.)

## SUPPLEMENT FOR L-H PUPPY RAISERS' MANUAL

### HOUSEBREAKING

Housebreaking a puppy is quite simple and it is a very fine accomplishment on the part of the puppy raiser, because all Guide Dogs have to live right in the house and sleep in the bedroom with their blind master. Here is how you do it. Make a simple bed of plywood or other wood, a large wooden goods box can be cut down to suit this purpose. Because your pup will grow very fast, it is better to make it so it will be large enough for him when he is grown. This will be at least four feet long and three feet wide. There should be three sides at least ten or twelve inches high to cut out any draft. The floor should be smooth so that nothing will injure the dog while he lies on it. Legs should hold the bed at least three inches off the floor allowing circulation underneath.

By inserting an "eye" screw in the wall behind the bed the puppy may be secured with a light chain, four or four and a half feet long. This allows the puppy to get off the bed, but not very far. It allows him complete freedom while on the bed. The chain should have at least one swivel to avoid fouling.

After the puppy has been taken outside at bedtime and allowed to eliminate, place him on the bed and snap chain into his collar ring. Stay with the puppy when you put him out until he has eliminated. He is likely to want to come in before he has, just to be with you, if you turn him out alone. As to leaving him out a couple of hours before bed time, here again you have no assurance he has eliminated. If you have him inside at least an hour before bed time and take him out, he is almost sure to eliminate quite quickly. Do not rush him. Most dogs "go" at least twice before they have completed elimination.



The bed may be used at any time that you want the puppy in the house but do not want him to wander around. It is also quite simple to teach him the word "bed". Call his name and say, "bed", every time you want him on the bed. If you do this before feeding and then free him directly in front of the bed, you will speed up the learning process. Naturally, the bed should never be used as punishment, nor should the dog be kept there day and night. House breaking may be accomplished just as well on a back porch, a sun room, even a harness room in the barn.

Dogs like to eliminate in the same area where they have gone before, that is they choose a place for their toilet. By taking them directly to this place you will save much time in elimination. If they have an accident in the house, take a little sand or soil, mix it with the eliminated matter, take this soil where you want the dog to "go" and leave it there. You will have told him this is where you want him to eliminate. Take him back to this place when you want him to "go" and you will soon establish this habit.

## SUPPLEMENT FOR L4-H PUPPY RAISERS' MANUAL

### COME

Once you have the "Sit stay" training accomplished, you will be ready to improve your "Come" exercise. At first, start just as you did on the "Stay". With leash attached to his collar, "Stay" your puppy and walk to the end of the leash, turn and face him and after a short interval, command "Judge, come". Make this command a very pleasant, happy one and if he hesitates, because of his "Stay" training, bring him to you gently with the leash, encouraging him all the time.

As he comes to you, you will have to help him. Pulling gently on the leash, bring him to your right side and as he clears the way for you, take a step forward and at the same time pass the leash behind you back to your left hand and across front to your right. This should lead him back to your left side. Have him sit there for a little while and then praise him. Three or four lessons a day will be all you should give of this exercise. Continue until he minds all these commands without any help from the leash.

Once this is accomplished, you may leave him at "Stay" without any leash on him. First stop about where you have been stopping while your leash limited the distance you could go from him. Day by day, go a step farther until you are a full ten steps from him. If he is not letter-perfect at any time, go back to using the leash and working the shorter distance.

(note: Many of us in obedience training have our dog come to heel in a different manner than that described here. The reason we ask you to use this type of "finish" is that a Guide Dog must go from right to left behind the blind person so that it will not trip its' master.)

## SUPPLEMENT FOR L-H PUPPY RAISERS' MANUAL

### RETRIEVING

Under the heading, "Praise Best Reward" on page 3 of your manual, you have been told how to teach your dog to retrieve. Now, you are going to compete with others and the better job your pup does, the better chance you will have to earn a high score. The only thing you have to do, to polish off the training you have been giving, is to teach him to come to you with the old rolled up felt hat, sit as he does in the "Come" exercise, and teach him to let you take the hat out of his mouth gently - without a struggle. The command for this is, "Judge, out". Then praise yourpuppy.

In both the "Come and the "Retrieving" exercises, once "Judge" has learned to come around to your right side on the command "Heel", do not step forward, but have him do it while you are standing still.

(Note: Should you have trouble in that your puppy does not want to fetch the old hat, directly to you, have him retrieve on the leash so that he must come to you or use a narrow hall or lane where there is no place for him to get away from you. Also be sure to bring the old hat, or whatever object he is accustomed to bringing to you, to the Field Day. No matter how nice something new might look, do not change. Dogs are creatures of habit. A new object might be his downfall and yours.

## SUPPLEMENT FOR L-H PUPPY RAISERS' MANUAL

### HEELING

In order to have your puppy ready for competition in heeling at the Field Day, you should now start working for more precision and smooth coordination between you and your dog. Before you give your puppy the command "Heel", have him sit at your left side. He must sit close with his head straight to the front.

When you are ready to start, get his attention by calling his name. When he looks up at you, command "Heel", and at once start with your left foot, always your left foot first. Walk as fast as you can keeping your pup close to your side with his chest even with your left knee or just a little ahead of it, but not enough ahead to cause him to try to cross over in front of you. Go Forward, make right turns, left turns and about turns. While you are teaching him, talk to him and encourage him by telling how well he is doing. If he does wrong, say "No", and show him what you want him to do.

Here are some tips about those turns you are making. Many people make awkward turns and foul their dog up in the leash or cause him to tighten the leash, because they do not give him a chance to come around with them. Try this - when you do an about-turn, do it when your left foot is out in front in a normal step. Raise up on both toes and face backwards by pivoting to your right. This will give your pup time to come around and continue with you at a regular pace. When you have made a turn keep on walking. To do a right turn, pivot on your toes exactly the same way but stop half way round, so you are facing right. To do a left turn, you still do it when your left foot is out front, but you use your right knee to spin you around as a counter balance. A little shove with your right foot starts you around; the weight of your right leg held up with knee forward carries you to a left face. The knee also blocks the progress of your pup so that he has to turn with you. Practice these turns by yourself until you have them down pat and then at once start using them in heeling your pup. Each time you stop, which should be quite often, say. "Judge sit", and see that he does it. Some serious work on this will help you win a ribbon and maybe a trophy at the Field Day.

## SUPPLEMENT FOR L-H PUPPY RAISERS' MANUAL

### SIT STAY

When you have stopped and your puppy is in the sitting position on your left side, give the command "Judge stay". You should always carry your leash in your right hand as your manual has told you. This gives you your left hand free to perfect the "Stay" command.

This is how you do it. As you give the command, make the left turn just as when heeling, but on the command "Stay", place your left hand directly in front of the puppy's nose with the palm toward him and hold it there while you pivot with right knee swinging to block his forward progress, should he try to go ahead. You will stop directly in front of your puppy. Withdraw your right hand gently so as not to cause him to move, stand there a short time, then walk directly to his right side and stop in the same position from which you started. As soon as you have returned, get down on your knee and praise the puppy with a lot of petting and kind words.

After a day or two of this you can take a step away from your pup, after you have turned to face him. His leash should be hanging loose. If he moves, when you back away two or three steps after seven or eight days training, you are doing very well.

When you have him sitting steady until you can back as far as possible and still hold the leash, then lay the leash over his back before you give the command and go through it as before. By the time you have progressed to where you can back ten steps away with your puppy steady, he should stay without you turning in front of him, simply on the command, "Stay".

Here is a tip. While teaching heeling, you have always started with your left foot making the first step. He has learned to follow that foot. So now, when you leave him, step off always with your right foot. You can still hold your hand in front of his face, when you leave him, but walk straight away ten steps and turn and face him. After a while, time yourself and be sure that he will remain sitting while you are away at least one full minute. When you return to him, always come directly to his right side, exactly where you left him. Stand there for a little while so he will remain steady, then praise him.

**CAN ANY BLIND PERSON GET A GUIDE DOG?**

Any legally blind person who is 16 years old and physically fit can apply for a Guide Dog.

**WHY DON'T ALL BLIND PEOPLE USE GUIDE DOGS?**

Not every blind person wants a dog. Some blind people prefer using a cane or going places with friends who can see. Having a Guide Dog is a big responsibility. The dog needs care, food, grooming, attention and love. Some people are allergic to dogs; some people just don't like dogs.

**IS IT OK TO PET A GUIDE DOG?**

Ask the blind person for permission first. Sometimes it distracts the Guide Dog from its work for a stranger to come up and pet it.

**ARE THERE A LOT OF DOGS AT THE GUIDE DOG CENTER?**

Yes! And school groups, scout troops and other public groups are welcome to visit them on weekdays or when there is a graduation ceremony. To find out about visiting the campus, call:

(415) 499-4000



# TELL ME ABOUT GUIDE DOGS!



### WHAT IS A GUIDE DOG?

A Guide Dog is a dog trained to help a blind person get around.

### WHAT KIND OF DOG IS A GUIDE DOG?

There are only 3 kinds of dogs trained at Guide Dogs for the Blind: GOLDEN RETRIEVERS, LABRADOR RETRIEVERS and GERMAN SHEPHERDS.



### HOW DOES A GUIDE DOG HELP A BLIND PERSON?

A Guide Dog helps its blind partner by walking the person around obstacles like telephone poles, mail boxes, street barricades, and by refusing to lead the blind person into a street when cars are coming.



### DOES THE GUIDE DOG KNOW WHERE THE BLIND PERSON WANTS TO GO?

No. All the Guide Dog does is follow orders; so the blind person has to know where the store or the post office or the bus stop is and then give the dog a series of commands in order to get there. Samples of commands are: "Forward," "Left," "Right."



### CAN A GUIDE DOG TELL WHEN A TRAFFIC LIGHT HAS CHANGED?

No. Dogs can't tell the difference between a red light and a green light. But they can watch and listen for traffic and will only cross a street when there are no cars coming. A Guide Dog will not cross a street if there is a car coming, even if its blind partner tells it to cross the street.

### ISN'T THE GUIDE DOG TRAINED TO OBEY ORDERS?

Yes, But they are also trained to disobey orders that could make their blind partners get hurt. This is why some people call Guide Dogs "thinking dogs."

### CAN ANY DOG BE TRAINED TO BE A GUIDE DOG?

Almost any dog can be trained to be a good pet. Being a Guide Dog is special work and it takes special training. We use only dogs that are part of the Guide Dog family. The puppies are born at our campus. They are raised by 4-H kids, and the young dogs are returned to us for training by teachers who are licensed instructors.

### HOW DOES THE BLIND PERSON LEARN TO USE THE DOG?

The blind person goes to school at our campus, usually for a month. During that time the person lives at our dormitory and practices with the Guide Dog everyday. The same instructors who trained the dogs teach the blind people how to use those dogs. The blind person is taught how to use the Guide Dog in the city, in the country, in offices, in stores, in restaurants and buses.



### ARE GUIDE DOGS ALLOWED IN RESTAURANTS?

Yes. The law allows Guide Dogs to go places that most pet dogs cannot go.

### HOW MUCH DOES THE BLIND PERSON PAY FOR THE GUIDE DOG?

Nothing. We give the blind person for free the dog, the training course, all food and housing during the course, the dog harness and other equipment. Plus, we send an instructor to visit each of our graduates at least once a year to make sure the person and dog are doing all right.

WITHERS	
FEATHERS	
MUZZLE	EYE
NOSE	PAD
EAR (LEATHER)	
OCCIPUT	
STIFLE	HOCK
PASTERN	
FLEWS (LIPS)	
BACK	STOP
CROUP	
BRISKET	TAIL
ELBOW	
LOIN	NECK
TUCK-UP	
SHOULDER	
SKULL	

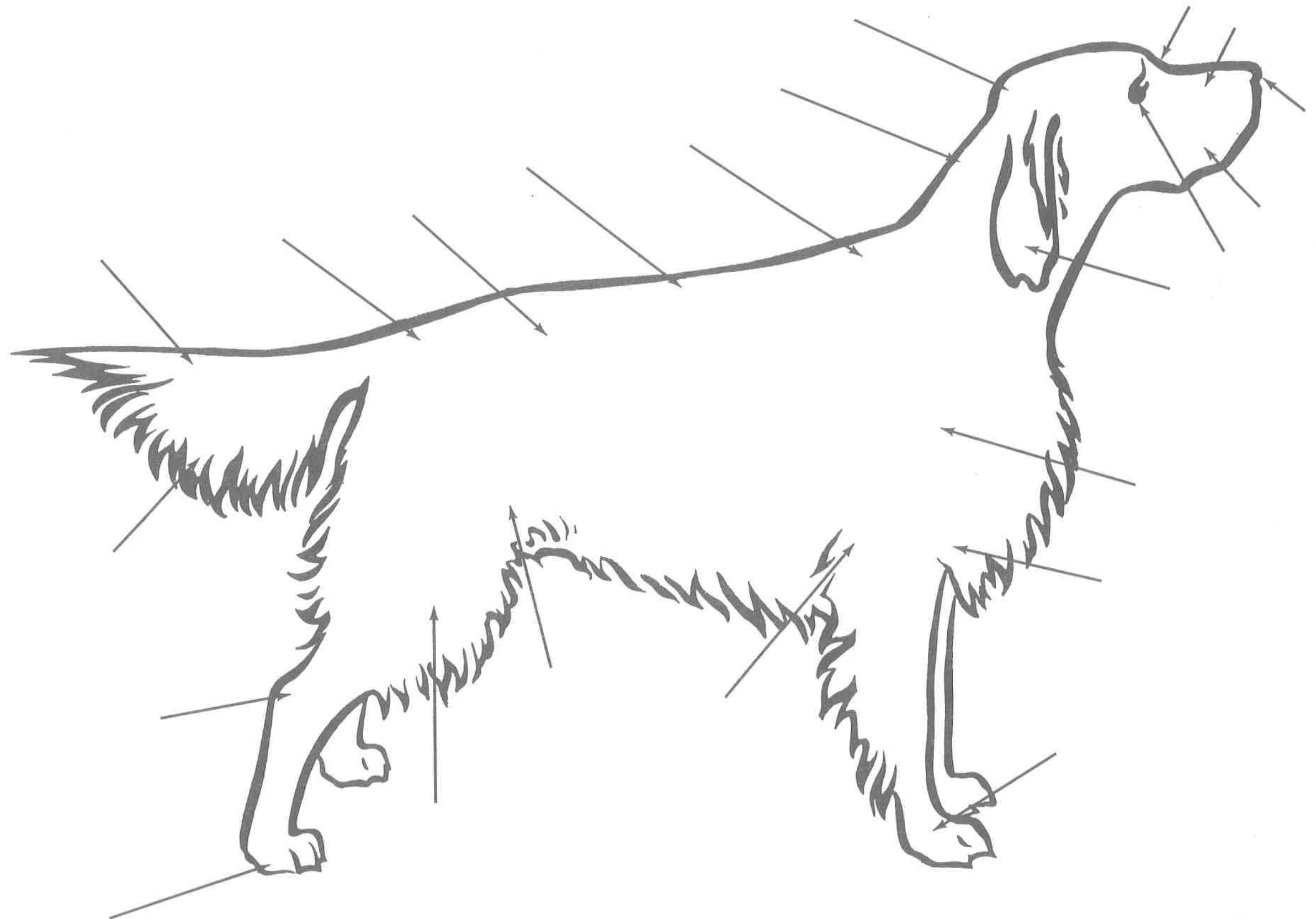

## DOG . . . *Parts Identification*



The University of California Cooperative Extension in compliance with the Civil Rights Act of 1964, Title IX of the Education Amendments of 1972, and the Rehabilitation Act of 1973 does not discriminate on the basis of race, creed, religion, color, national origin, sex, or mental or physical handicap in any of its programs or activities. Inquiries regarding this policy may be directed to: Affirmative Action Officer, Cooperative Extension, 317 University Hall, University of California, Berkeley, California 94720, (415) 642-0903.

COOPERATIVE EXTENSION  
UNIVERSITY OF CALIFORNIA

Issued in furtherance of Cooperative Extension work, Acts of May 8 and June 30, 1914, in cooperation with the United States Department of Agriculture, James B. Kendrick, Jr., Director, Cooperative Extension, University of California.